

客戶名稱 : \_\_\_\_\_  
 Customer : \_\_\_\_\_  
 規格型號 : 16K1-B5K, L-20F  
 Model : 16K1-B5K, L-20F

### General 一般事項



使用溫度範圍 Operating temperature	-10 °C ~ +70 °C
手工焊接 Manual soldering	300 °C Max 3sec

### Electrical Characteristics 電氣特性

總阻值(R) Total resistance	5K
總阻值容許誤差 Resistance tolerance	±20%
阻值線性 Resistance taper	B
摺動雜音 Sliding noise	Less than 47 mV
殘留阻值 Residual resistance	Less than 20Ω
定格電力 Rated power(W)	Linear (B) taper : 0.125 W Other taper : 0.06W
額定電壓 Rated voltage(V)	$E = \sqrt{P \cdot R}$ E : Rated voltage 額定電壓 (V) P : Power rating 額定電力 (W) R : Nominal total resistance 公稱全阻抗值 (Ω) 當額定電壓超過最高使用電壓的時候，最高使用電壓即為額定電壓 When the rated voltage exceeds the maximum operating voltage, the maximum operating voltage shall be the rated voltage.
最高使用電壓 Max. operating voltage	Linear (B) taper : 200 V Other taper : 150 V
絕緣阻抗 Insulation resistance	More than 100 MΩ at DC 500 V
耐電壓 Withstand voltage	1 Minute at AC 500 V

### Mechanical Characteristics 機械特性

全回轉角度 Total rotational angle	300 °±5 °
全回扭力 Rotational torque	30~200 gf.cm
C.C 扭力 C.C torque	<input type="checkbox"/> 100~350gf.cm
全回轉止強度 Rotational stopper strength	6 kgf.cm max.
軸推拉強度 Shaft push-pull strength	7 kgf.cm max.
回轉壽命 Rotational life	15,000 Cycles

核准 Approval	審核 Auditing	校對 Checked	製作 Projected
			

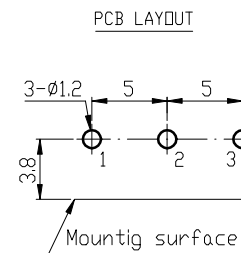
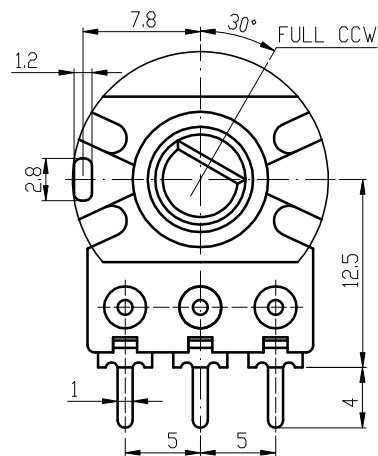
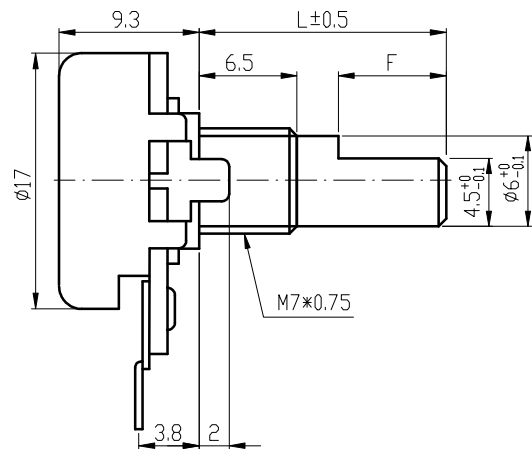

CIRCUIT

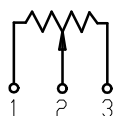

2015.07.03

未標註公差

L =	10	15	17	20	25	30	10 以下	±0.3
F =	2.5	7	7	12	12	12	10 ~100	±0.5
choose				✓			100 以上	±0.8

**FLYiNG**  
INTERNATIONAL

規格型號:16K1(F)

核准:

**工程**  
 '15.07.03  
 藍濬毅

審核:

**品管**  
 '15.07.03  
 蘇淑英

製圖:

**工程**  
 '15.07.03  
 陳俊宏

單位

mm

比例

2:1

版本

1.0

製圖日期

2009.10.01

編號

R16N-002

第三角法

<input type="checkbox"/> 目	修正	<input type="checkbox"/> 容	修正人 日期
修正記事			