



2N3904

NPN SILICON TRANSISTOR

NPN GENERAL PURPOSE AMPLIFIER

■ FEATURES

- * Collector-Emitter Voltage: $V_{CE0}=40V$
- * Complementary to 2N3906

■ FEATURES

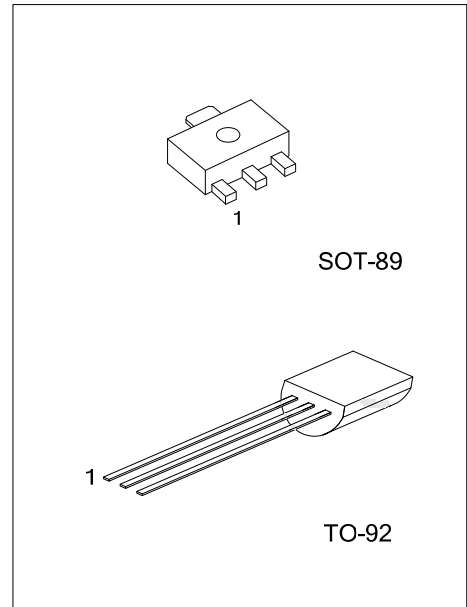
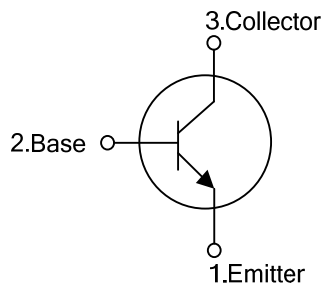

■ ORDERING INFORMATION

Ordering Number		Package	Pin Assignment			Packing
Lead Free	Halogen Free		1	2	3	
2N3904L-AB3-R	2N3904G-AB3-R	SOT-89	B	C	E	Tape Reel
2N3904L-T92-B	2N3904G-T92-B	TO-92	E	B	C	Tape Box
2N3904L-T92-K	2N3904G-T92-K	TO-92	E	B	C	Bulk

Note: Pin Assignment: B: Base C: Collector E: Emitter

<p>2N3904G-AB3-R</p>	<p>(1) B: Tape Box, K: Bulk, R: Tape Reel (2) AB3: SOT-89, T92: TO-92 (3) G: Halogen Free and Lead Free, L: Lead Free</p>
----------------------	---

■ MARKING

SOT-89	TO-92

■ ABSOLUTE MAXIMUM RATING ($T_A=25^\circ\text{C}$, unless otherwise specified)

PARAMETER		SYMBOL	RATINGS	UNIT
Collector-Base Voltage		V_{CBO}	60	V
Collector-Emitter Voltage		V_{CEO}	40	V
Emitter-Base Voltage		V_{EBO}	6	V
Collector Current		I_C	200	mA
Collector Dissipation	SOT-89	P_C	500	mW
	TO-92		625	
Junction Temperature		T_J	+150	$^\circ\text{C}$
Operating and Storage Temperature		T_{STG}	-55 ~ +150	$^\circ\text{C}$

Note: Absolute maximum ratings are those values beyond which the device could be permanently damaged. Absolute maximum ratings are stress ratings only and functional device operation is not implied.

■ THERMAL DATA

PARAMETER		SYMBOL	RATING	UNIT
Junction to Ambient	SOT-89	θ_{JA}	220	$^\circ\text{C/W}$
	TO-92		200	$^\circ\text{C/W}$
Junction to Case	SOT-89	θ_{JC}	38	$^\circ\text{C/W}$
	TO-92		83.3	$^\circ\text{C/W}$

■ ELECTRICAL CHARACTERISTICS ($T_A=25^\circ\text{C}$, unless otherwise specified)

PARAMETER	SYMBOL	TEST CONDITIONS	MIN	TYP	MAX	UNIT
Collector-Base Breakdown Voltage	BV_{CBO}	$I_C=10\mu\text{A}, I_E=0$	60			V
Collector-Emitter Breakdown Voltage	BV_{CEO}	$I_C=1\text{mA}, I_B=0$ (Note)	40			V
Emitter-Base Breakdown Voltage	BV_{EBO}	$I_E=10\mu\text{A}, I_C=0$	6			V
Collector-Emitter Saturation Voltage (Note)	$V_{CE(SAT)1}$	$I_C=10\text{mA}, I_B=1\text{mA}$			0.2	V
	$V_{CE(SAT)2}$	$I_C=50\text{mA}, I_B=5\text{mA}$			0.3	V
Base-Emitter Saturation Voltage (Note)	$V_{BE(SAT)1}$	$I_C=10\text{mA}, I_B=1\text{mA}$	0.65		0.85	V
	$V_{BE(SAT)2}$	$I_C=50\text{mA}, I_B=5\text{mA}$			0.95	V
Collector Cut-off Current	I_{CBO}	$V_{CE}=30\text{V}, V_{EB}=3\text{V}$			50	nA
Base Cut-off Current	I_{BL}	$V_{CE}=30\text{V}, V_{EB}=3\text{V}$			50	nA
DC Current Gain (note)	h_{FE1}	$V_{CE}=1\text{V}, I_C=0.1\text{mA}$	40			
	h_{FE2}	$V_{CE}=1\text{V}, I_C=1\text{mA}$	70			
	h_{FE3}	$V_{CE}=1\text{V}, I_C=10\text{mA}$	100		300	
	h_{FE4}	$V_{CE}=1\text{V}, I_C=50\text{mA}$	60			
	h_{FE5}	$V_{CE}=1\text{V}, I_C=100\text{mA}$	30			
Current Gain Bandwidth Product	f_T	$V_{CE}=20\text{V}, I_C=10\text{mA}, f=100\text{MHz}$	300			MHz
Output Capacitance	C_{OB}	$V_{CB}=5\text{V}, I_E=0, f=1\text{MHz}$			4	pF
Turn on Time	t_{ON}	$V_{CC}=3\text{V}, V_{BE}=0.5\text{V}, I_C=10\text{mA}, I_{B1}=1\text{mA}$			70	ns
Turn off Time	t_{OFF}	$I_{B1}=1\text{mA}, I_{B2}=1\text{mA}$			250	ns

Note: Pulse test: Pulse Width $\leq 300\mu\text{s}$, Duty Cycle $\leq 2\%$

■ TYPICAL CHARACTERISTICS

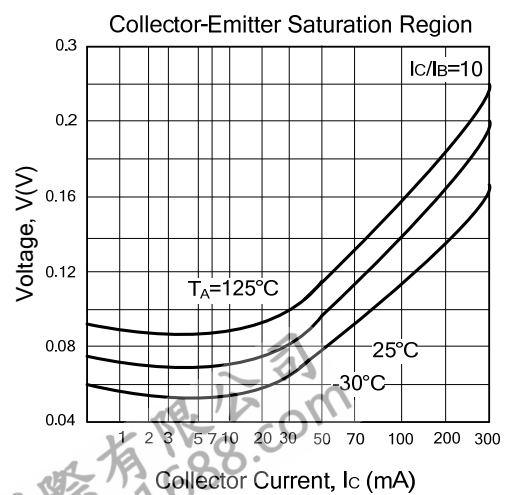
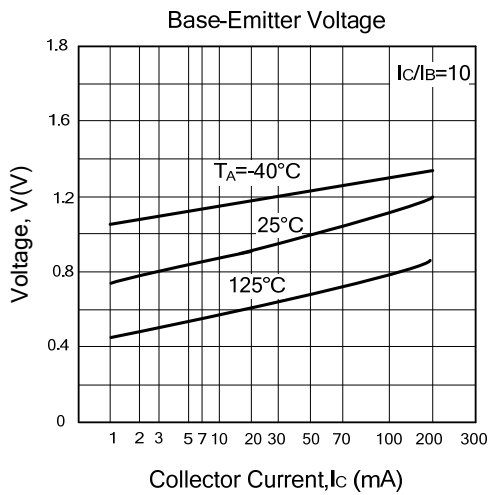
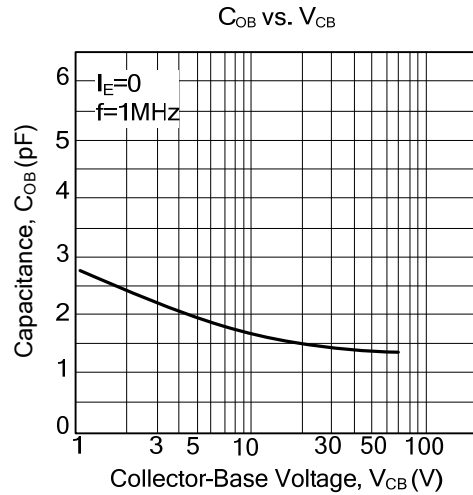
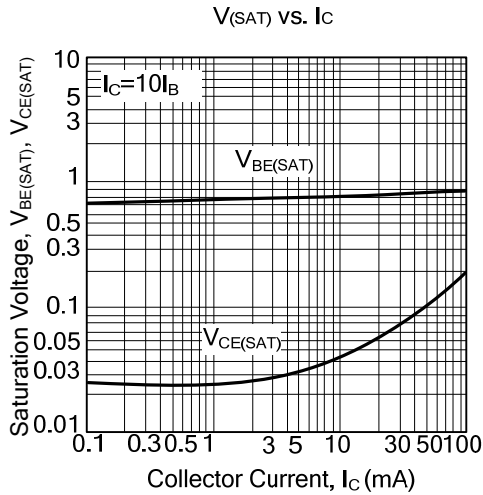
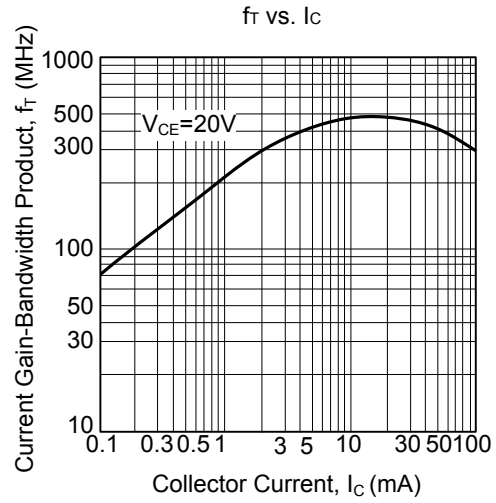
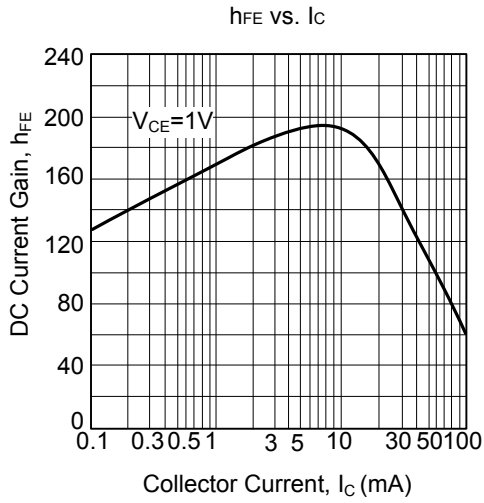

■ TYPICAL CHARACTERISTICS(Cont.)

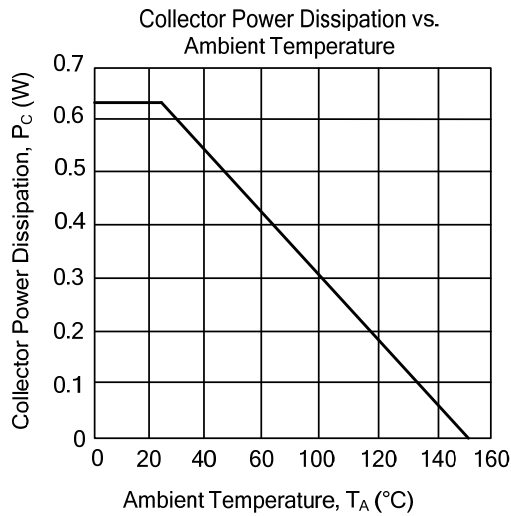

UTC assumes no responsibility for equipment failures that result from using products at values that exceed, even momentarily, rated values (such as maximum ratings, operating condition ranges, or other parameters) listed in products specifications of any and all UTC products described or contained herein. UTC products are not designed for use in life support appliances, devices or systems where malfunction of these products can be reasonably expected to result in personal injury. Reproduction in whole or in part is prohibited without the prior written consent of the copyright owner. The information presented in this document does not form part of any quotation or contract, is believed to be accurate and reliable and may be changed without notice.