



2N7002

Power MOSFET

0.3A, 60V N-CHANNEL POWER MOSFET

DESCRIPTION

The UTC **2N7002** uses advanced technology to provide excellent $R_{DS(ON)}$, low gate charge and operation with low gate voltages. This device is suitable for use as a load switch or in PWM applications.

FEATURES

- * High Density Cell Design for Low $R_{DS(ON)}$.
- * Voltage Controlled Small Signal Switch
- * Rugged and Reliable
- * High Saturation Current Capability

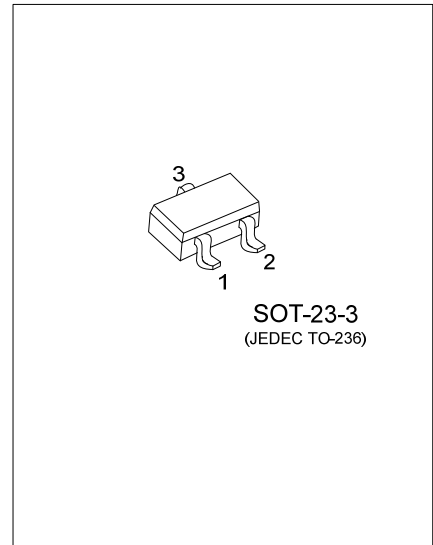

SYMBOL

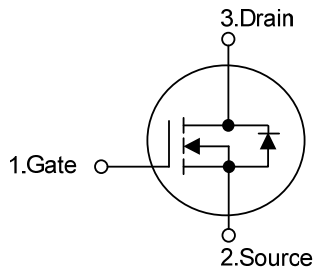

ORDERING INFORMATION

Ordering Number		Package	Pin Assignment			Packing
Lead Free	Halogen Free		1	2	3	
2N7002L-AE2-R	2N7002G-AE2-R	SOT-23-3	G	S	D	Tape Reel

Note: Pin Assignment: G: Gate S: Source D: Drain

2N7002G-AE2-R	(1)Packing Type	(1) R: Tape Reel
	(2)Package Type	(2) AE2: SOT-23-3
	(3)Green Package	(3) G: Halogen Free and Lead Free, L: Lead Free

MARKING

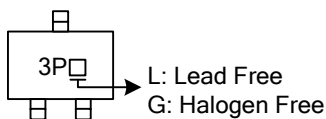

■ ABSOLUTE MAXIMUM RATINGS (T_A=25°C, unless otherwise specified.)

PARAMETER	SYMBOL	RATINGS	UNIT
Drain-Source Voltage	V _{DSS}	60	V
Drain-Gate Voltage (R _{GS} ≤1MΩ)	V _{DGR}	60	V
Gate Source Voltage	V _{GSS}	±20	V
		±40	
Drain Current	I _D	300	mA
		800	
Power Dissipation	P _D	200	mW
Derated Above 25°C		1.6	mW/°C
Junction Temperature	T _J	+ 150	°C
Storage Temperature	T _{STG}	-55 ~ +150	°C

Note: Absolute maximum ratings are those values beyond which the device could be permanently damaged. Absolute maximum ratings are stress ratings only and functional device operation is not implied.

■ THERMAL CHARACTERISTICS

PARAMETER	SYMBOL	RATINGS	UNIT
Junction to Ambient	θ _{JA}	625	°C/W
Junction to Case	θ _{JC}	215	°C/W

■ ELECTRICAL CHARACTERISTICS (T_A=25°C, unless otherwise specified)

PARAMETER	SYMBOL	TEST CONDITIONS	MIN	TYP	MAX	UNIT
OFF CHARACTERISTICS						
Drain-Source Breakdown Voltage	BV _{DSS}	V _{GS} =0V, I _D =10μA	60			V
Drain-Source Leakage Current	I _{DSS}	V _{DS} =60V, V _{GS} =0V			1	μA
Gate-Source Leakage Current	I _{GSSF}	V _{GS} =20V, V _{DS} =0V			100	nA
		V _{GS} =-20V, V _{DS} =0V			-100	nA
ON CHARACTERISTICS (Note)						
Gate Threshold Voltage	V _{GS(TH)}	V _{GS} =V _{DS} , I _D =250μA	1	2.1	2.5	V
Drain-Source On-Voltage	V _{DS(ON)}	V _{GS} =10V, I _D =300mA		0.6	3.75	V
		V _{GS} =5.0V, I _D =50mA			0.375	
Static Drain-Source On-Resistance	R _{DS(ON)}	V _{GS} =10V, I _D =300mA			2.0	Ω
		V _{GS} =5.0V, I _D =50mA			3.0	Ω
DYNAMIC CHARACTERISTICS						
Input Capacitance	C _{ISS}	V _{DS} =25V, V _{GS} =0V, f=1.0MHz			50	pF
Output Capacitance	C _{OSS}				25	pF
Reverse Transfer Capacitance	C _{RSS}				5	pF
Turn-On Time	t _{ON}	V _{DD} =30V, R _L =150Ω, I _D =200mA,			20	nS
Turn-Off Time	t _{OFF}	V _{GS} =10V, R _G =25Ω			20	nS
DRAIN-SOURCE DIODE CHARACTERISTICS AND MAXIMUM RATINGS						
Maximum Continuous Drain-Source Diode Forward Current	I _S				300	mA
Maximum Pulsed Drain-Source Diode Forward Current	I _{SM}				0.8	A
Drain-Source Diode Forward Voltage	V _{SD}	V _{GS} =0V, I _S =300mA (Note)	0.88	1.5		V

Note: Pulse Test: Pulse Width≤300μs, Duty Cycle≤2.0%

■ TEST CIRCUIT AND WAVEFORM

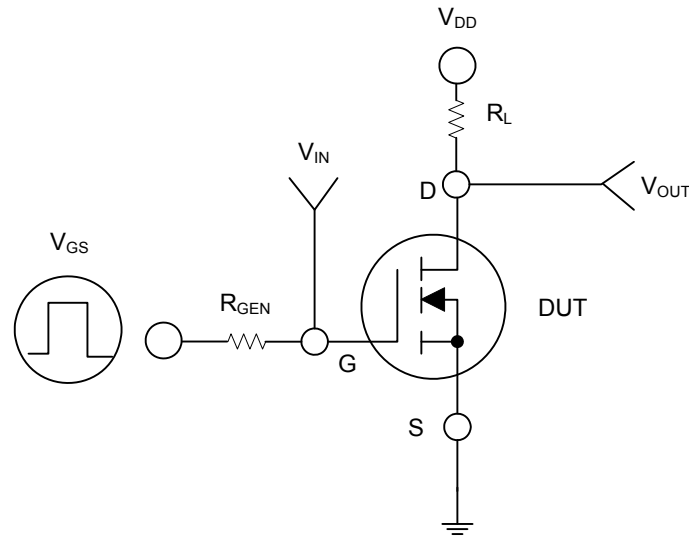

Fig. 1

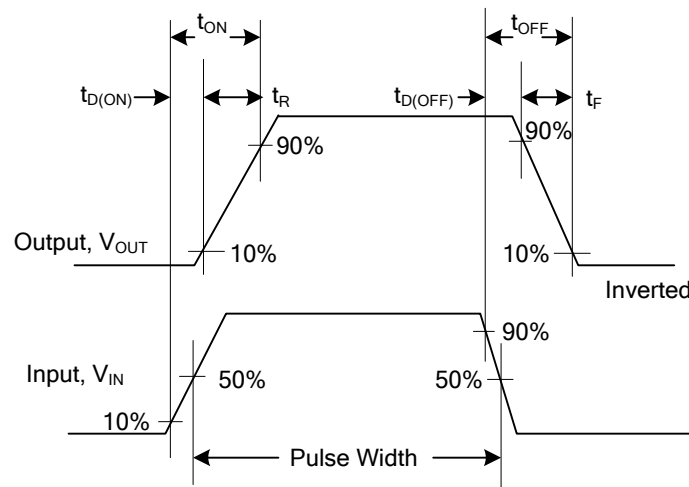
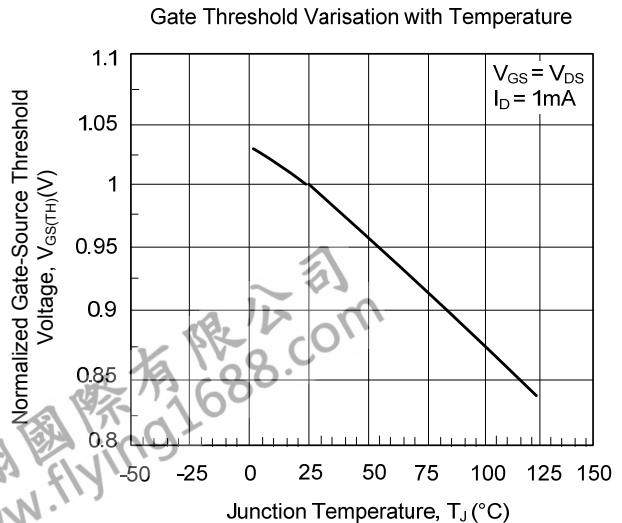
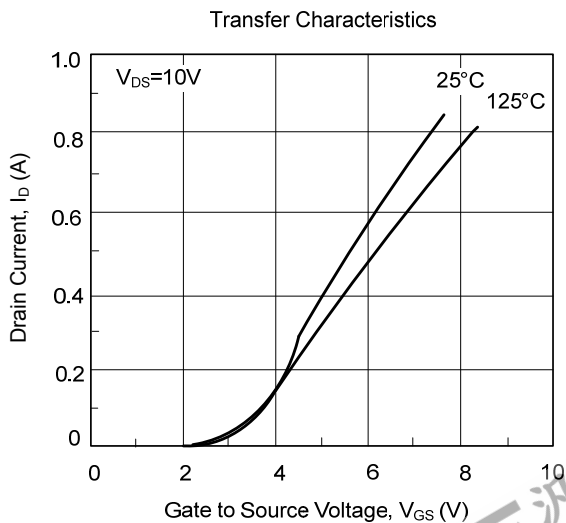
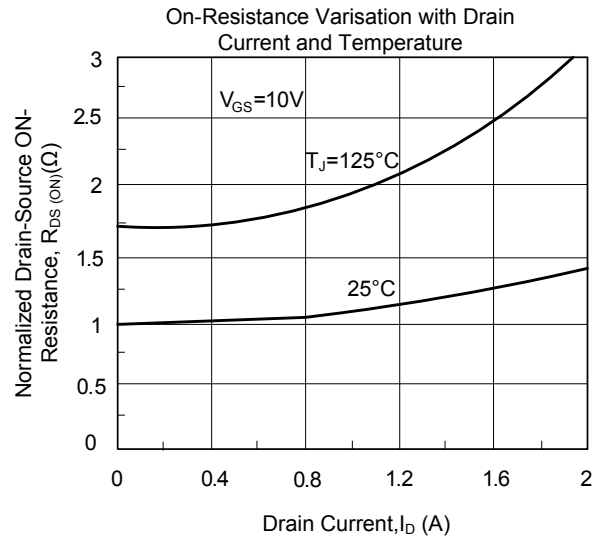
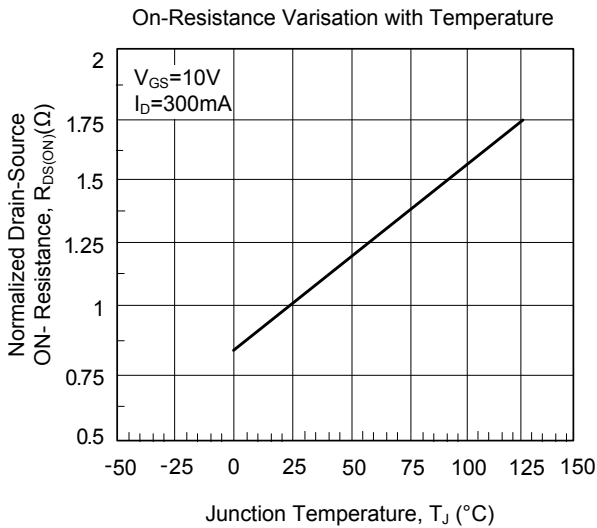
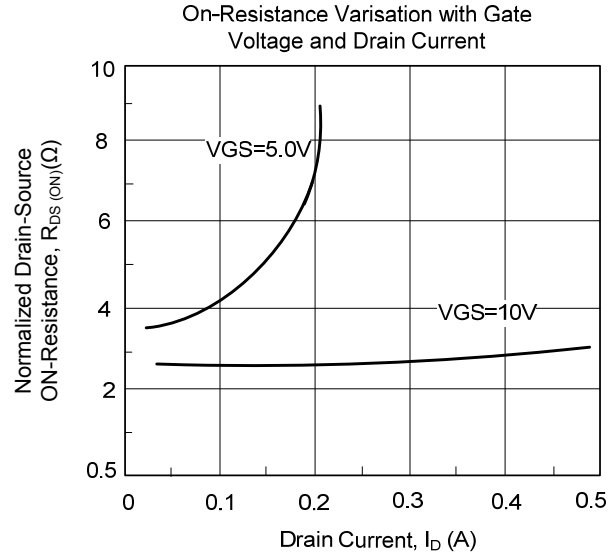
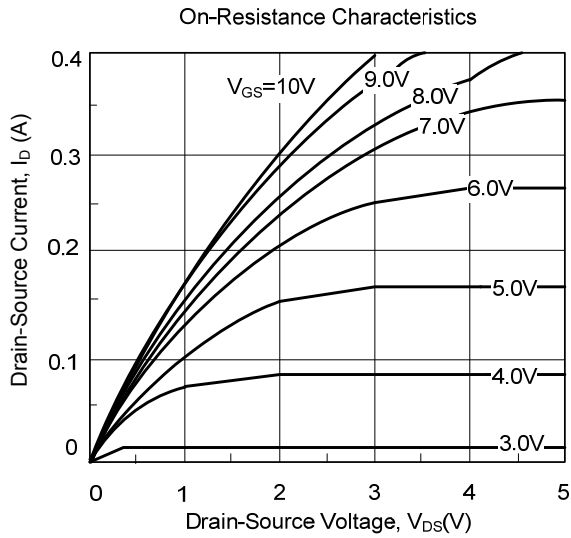

Fig. 2 Switching Waveforms

FLYING 汎翔國際有限公司
www.flying1688.com

■ TYPICAL CHARACTERISTICS



■ TYPICAL CHARACTERISTICS (Cont.)

Breakdown Voltage Variation with Temperature

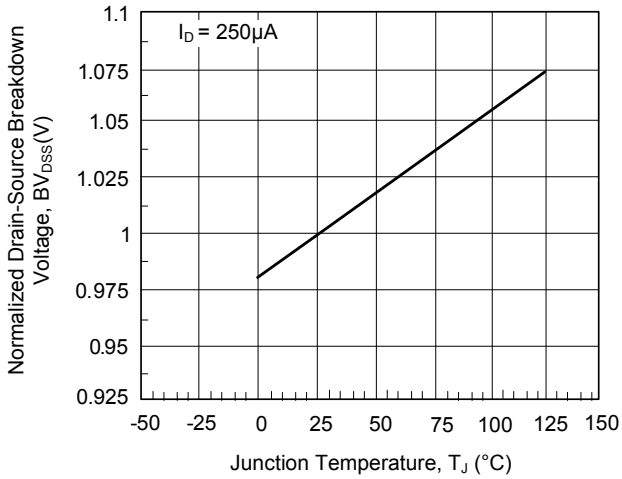

Body Diode Forward Voltage Variation with Temperature

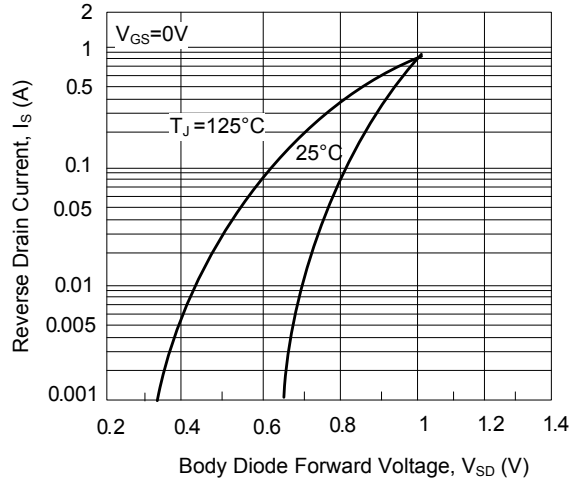

Capacitance Characteristics

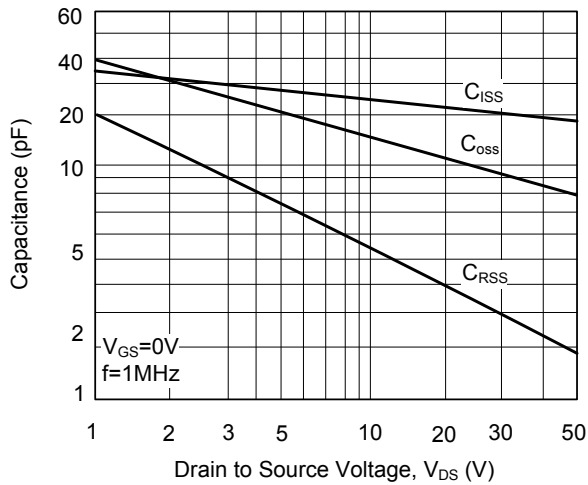

Gate Charge Characteristics

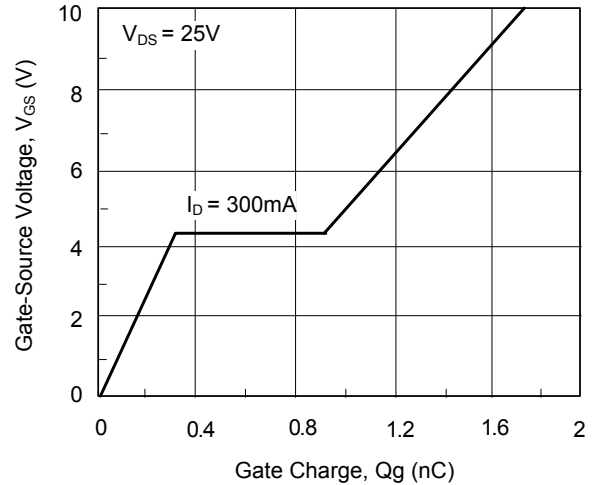

Maximum Safe Operating Area

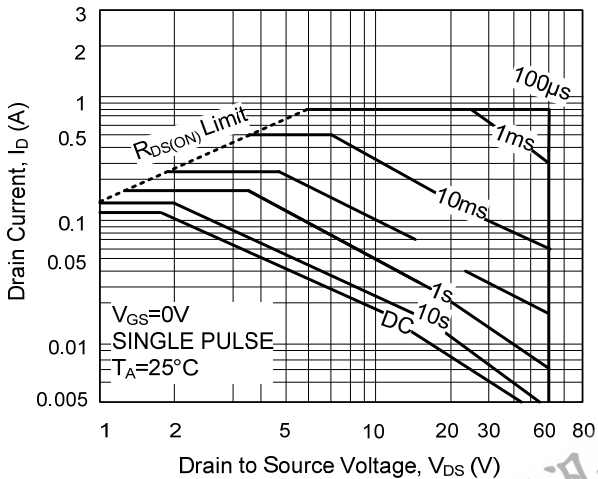

Transient Thermal Response Curve

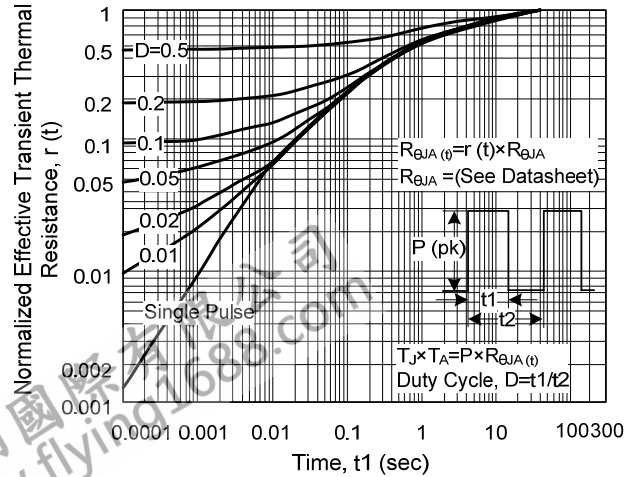

UTC assumes no responsibility for equipment failures that result from using products at values that exceed, even momentarily, rated values (such as maximum ratings, operating condition ranges, or other parameters) listed in products specifications of any and all UTC products described or contained herein. UTC products are not designed for use in life support appliances, devices or systems where malfunction of these products can be reasonably expected to result in personal injury. Reproduction in whole or in part is prohibited without the prior written consent of the copyright owner. UTC reserves the right to make changes to information published in this document, including without limitation specifications and product descriptions, at any time and without notice. This document supersedes and replaces all information supplied prior to the publication hereof.