



2N7002K

Power MOSFET

300mA, 60V N-CHANNEL ENHANCEMENT MODE MOSFET

DESCRIPTION

The UTC **2N7002K** uses advanced technology to provide excellent $R_{DS(ON)}$, low gate charge and low gate voltages during operation. This device is suitable for use as a load switch or in PWM applications.

FEATURES

- * Low Reverse Transfer Capacitance (C_{RSS} = typical 3.0 pF)
- * ESD Protected
- * Fast Switching Capability
- * Avalanche Energy Specified
- * Improved dv/dt Capability, High Ruggedness

SYMBOL

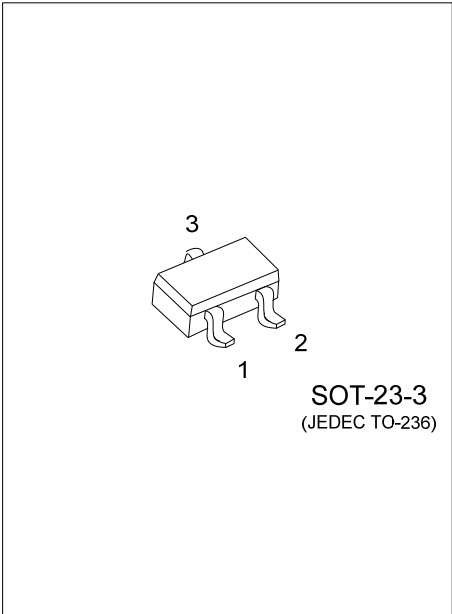
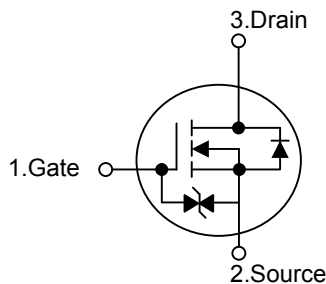

ORDERING INFORMATION

Ordering Number		Package	Pin Assignment			Packing
Lead Free	Halogen Free		1	2	3	
2N7002KL-AE2-R	2N7002KG-AE2-R	SOT-23-3	G	S	D	Tape Reel

Note: Pin Assignment: G: Gate S: Source D: Drain

<p>2N7002KG-AE2-R</p> <p>(1) Packing Type (2) Package Type (3) Green Package</p>	<p>(1) R: Tape Reel (2) AE2: SOT-23-3 (3) G: Halogen Free and Lead Free, L: Lead Free</p>
--	---

MARKING

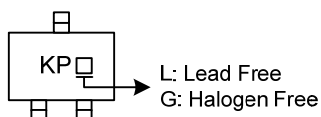

■ ABSOLUTE MAXIMUM RATINGS ($T_A = 25^\circ\text{C}$, unless otherwise specified.)

PARAMETER	SYMBOL	RATINGS	UNIT
Drain-Source Voltage	V_{DSS}	60	V
Gate-Source Voltage	V_{GSS}	± 20	V
Drain Current	Continuous	300	mA
	Pulse(Note 2)	800	
Power Dissipation	P_D	350	mW
Derating above $T_A=25^\circ\text{C}$		2.8	mW/ $^\circ\text{C}$
Junction Temperature	T_J	+150	$^\circ\text{C}$
Storage Temperature	T_{STG}	-55 ~ +150	$^\circ\text{C}$

Note: Absolute maximum ratings are those values beyond which the device could be permanently damaged. Absolute maximum ratings are stress ratings only and functional device operation is not implied.

■ ELECTRICAL CHARACTERISTICS ($T_A=25^\circ\text{C}$, unless otherwise specified.)

PARAMETER	SYMBOL	TEST CONDITIONS	MIN	TYP	MAX	UNIT
OFF CHARACTERISTICS						
Drain-Source Breakdown Voltage	BV_{DSS}	$V_{GS}=0\text{V}, I_D=10\mu\text{A}$	60			V
Drain-Source Leakage Current	I_{DSS}	$V_{DS}=60\text{V}, V_{GS}=0\text{V}$			1.0	μA
Gate-Source Leakage Current	I_{GSS}	$V_{DS}=0\text{V}, V_{GS}=\pm 20\text{V}$			± 10	μA
ON CHARACTERISTICS						
Gate Threshold Voltage	$V_{GS(TH)}$	$V_{DS}=10\text{V}, I_D=1\text{mA}$	1.0	1.85	2.5	V
Static Drain-Source On-Resistance (Note)	$R_{DS(ON)}$	$V_{GS}=10\text{V}, I_D=300\text{mA}$			2	Ω
		$V_{GS}=4.5\text{V}, I_D=200\text{mA}$			4	Ω
DYNAMIC PARAMETERS						
Input Capacitance (Note 1)	C_{ISS}	$V_{DS}=25\text{V}, V_{GS}=0\text{V}, f=1.0\text{MHz}$		25		pF
Output Capacitance	C_{OSS}			11		pF
Reverse Transfer Capacitance	C_{RSS}			5		pF
SWITCHING PARAMETERS						
Total Gate Charge (Note 1)	Q_G	$V_{DS}=48\text{V}, V_{GS}=10\text{V}, I_D=0.3\text{A}$ $I_G=1\text{mA}$ (Note 1, 2)		5.22		nC
Gate to Source Charge	Q_{GS}			1.8		nC
Gate to Drain Charge	Q_{GD}			0.8		nC
Turn-ON Delay Time	$t_{D(ON)}$	$I_D=0.2\text{A}, V_{DD}=30\text{V}, V_{GS}=10\text{V},$ $R_L=150\Omega, R_G=10\Omega$		12		ns
Turn-OFF Delay Time	$t_{D(OFF)}$			20		ns
DRAIN-SOURCE DIODE CHARACTERISTICS AND MAXIMUM RATINGS						
Maximum Continuous Drain-Source Diode Forward Current	I_S				300	mA
Maximum Pulsed Drain-Source Diode Forward Current	I_{SM}				0.8	A
Drain-Source Diode Forward Voltage	V_{SD}	$V_{GS}=0\text{V}, I^S=300\text{mA}$ (Note)		0.88	1.5	V

Notes: 1. Device mounted on FR-4 PCB, 1 inch x 0.85 inch x 0.062 inch. Minimum land pad size.

2. Pulse width $\leq 300\mu\text{s}$, Duty cycle $\leq 1\%$

■ TEST CIRCUITS AND WAVEFORMS

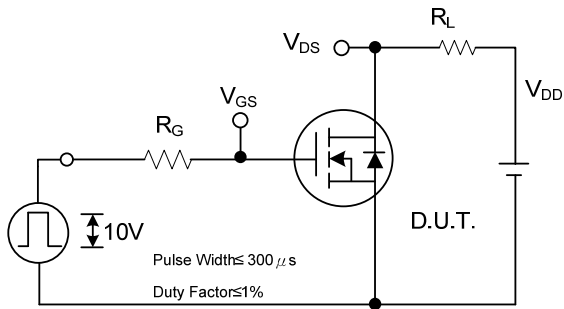

Switching Test Circuit

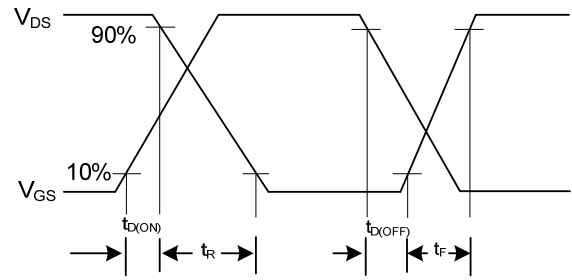

Switching Waveforms

TYPICAL CHARACTERISTICS

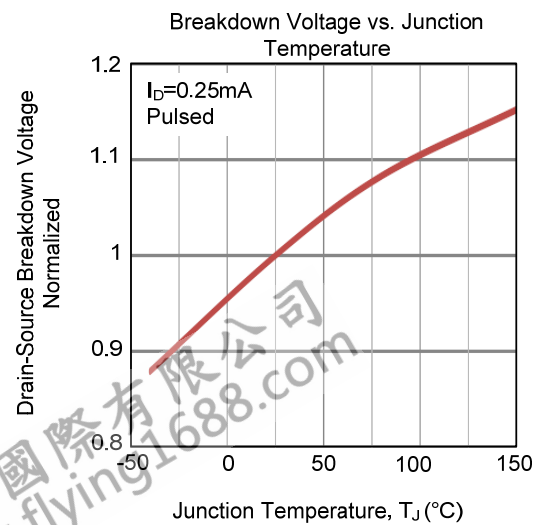
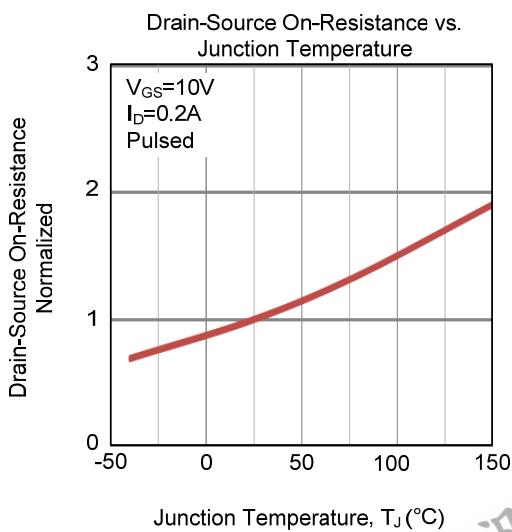
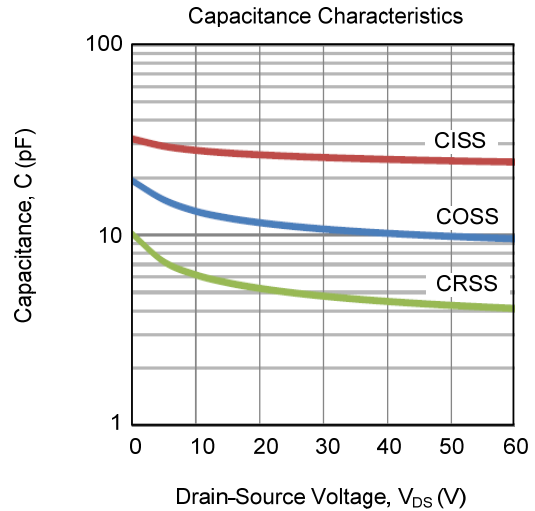
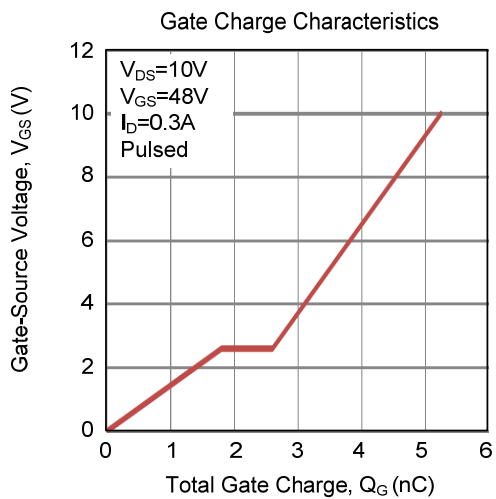
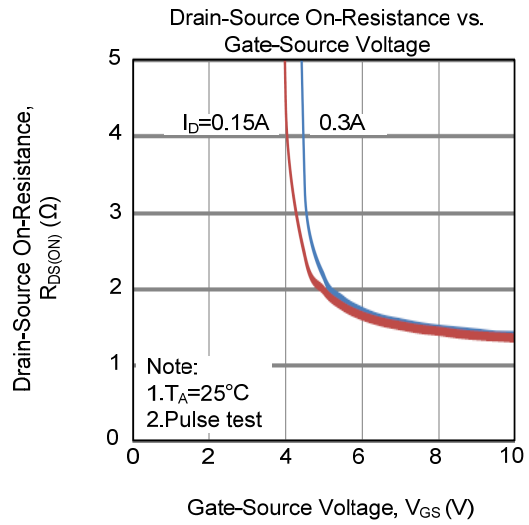
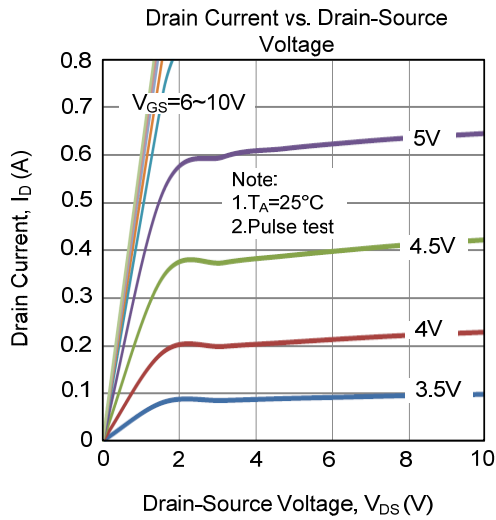

TYPICAL CHARACTERISTICS (Cont.)

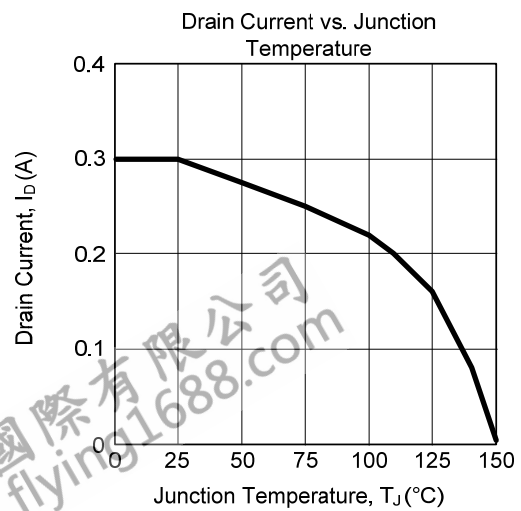
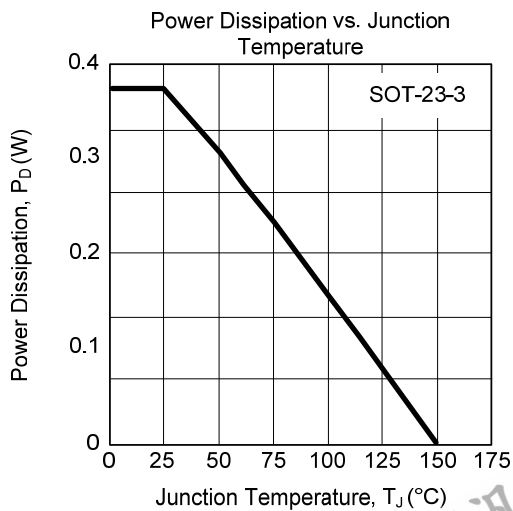
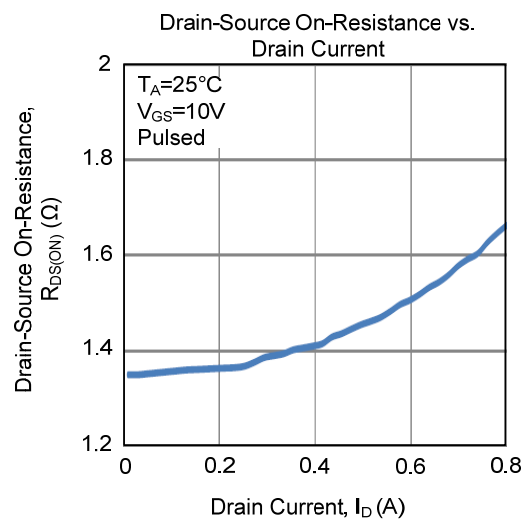
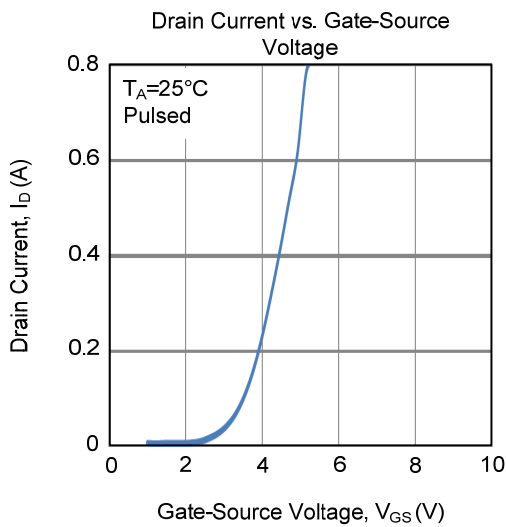
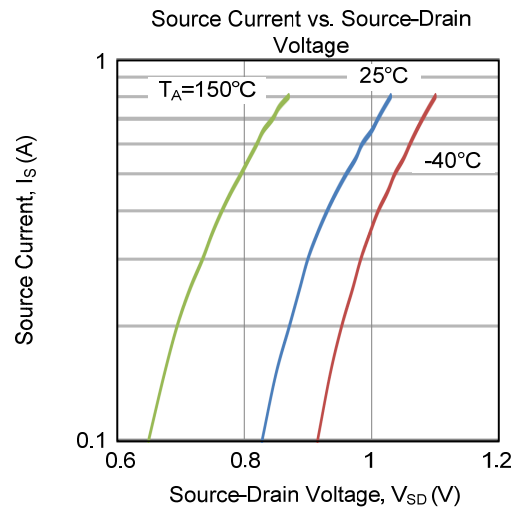
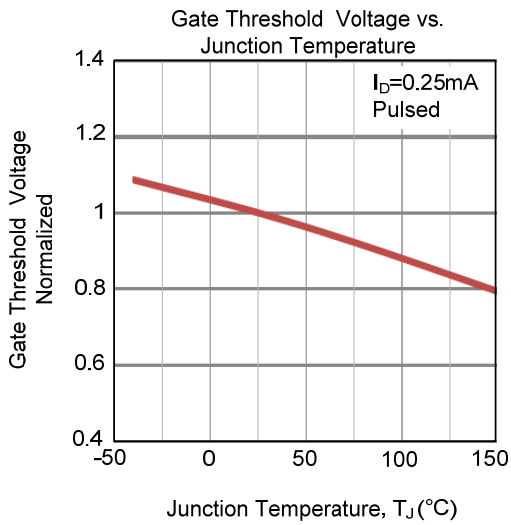

■ TYPICAL CHARACTERISTICS (Cont.)

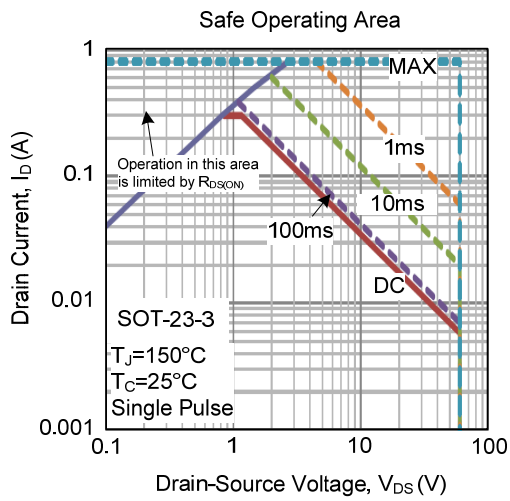

UTC assumes no responsibility for equipment failures that result from using products at values that exceed, even momentarily, rated values (such as maximum ratings, operating condition ranges, or other parameters) listed in products specifications of any and all UTC products described or contained herein. UTC products are not designed for use in life support appliances, devices or systems where malfunction of these products can be reasonably expected to result in personal injury. Reproduction in whole or in part is prohibited without the prior written consent of the copyright owner. UTC reserves the right to make changes to information published in this document, including without limitation specifications and product descriptions, at any time and without notice. This document supersedes and replaces all information supplied prior to the publication hereof.