

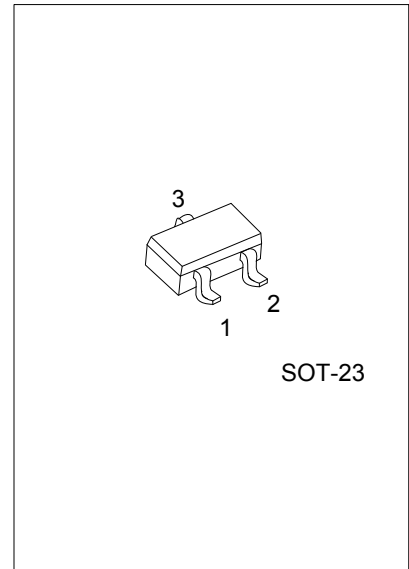

## 2SC1623

## NPN SILICON TRANSISTOR

AUDIO FREQUENCY GENERAL PURPOSE AMPLIFIER NPN SILICON TRANSISTOR MINI MOLD



### DESCRIPTION

The UTC **2SC1623** is a NPN silicon transistor using UTC's advanced technology to provide customers with high DC current gain and high breakdown voltage.

The UTC **2SC1623** is usually used in audio frequency general purpose amplifier.

### FEATURES

- \* High breakdown Voltage
- \* High DC Current Gain

### ORDERING INFORMATION

Ordering Number		Package	Pin Assignment			Packing
Lead Free	Halogen Free		1	2	3	
2SC1623L-xx-AE3-R	2SC1623G-xx-AE3-R	SOT-23	B	E	C	Tape Reel

Note: Pin Assignment: B: Base E: Emitter C: Collector

<p>2SC1623G-xx-AE3-R</p> <p>(1) Packing Type (2) Package Type (3) Rank (4) Green Package</p>	<p>(1) R: Tape Reel (2) AE3: SOT-23 (3) xx: refer to Classification of <math>h_{FE}</math> (4) G: Halogen Free and Lead Free, L: Lead Free</p>
--	--

### MARKING

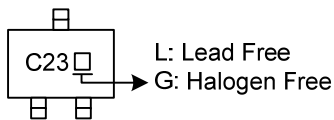

■ ABSOLUTE MAXIMUM RATINGS ( $T_A=25^\circ\text{C}$ , unless otherwise specified)

PARAMETER	SYMBOL	RATINGS	UNIT
Collector to Base Voltage	$V_{CBO}$	60	V
Collector to Emitter Voltage	$V_{CEO}$	50	V
Emitter to Base Voltage	$V_{EBO}$	5.0	V
Collector Current (DC)	$I_C$	100	mA
Power Dissipation	$P_D$	200	mW
Junction Temperature	$T_J$	+150	$^\circ\text{C}$
Storage Temperature	$T_{STG}$	-55 ~ +150	$^\circ\text{C}$

Note: Absolute maximum ratings are those values beyond which the device could be permanently damaged. Absolute maximum ratings are stress ratings only and functional device operation is not implied.

■ ELECTRICAL CHARACTERISTICS ( $T_A=25^\circ\text{C}$ , unless otherwise specified)

PARAMETER	SYMBOL	TEST CONDITIONS	MIN	TYP	MAX	UNIT
Collector Cutoff Current	$I_{CBO}$	$V_{CB}=60\text{V}, I_E=0$			0.1	$\mu\text{A}$
Emitter Cutoff Current	$I_{EBO}$	$V_{EB}=5.0\text{V}, I_C=0$			0.1	$\mu\text{A}$
DC Current Gain	$h_{FE}$	$V_{CE}=6.0\text{V}, I_C=1.0\text{mA}$ (Note 1)	90		600	
Collector Saturation Voltage	$V_{CE(SAT)}$	$I_C=100\text{mA}, I_B=10\text{mA}$ (Note 1)			0.3	V
Base to Saturation Voltage	$V_{BE(SAT)}$	$I_C=100\text{mA}, I_B=10\text{mA}$ (Note 1)			1.0	V
Base Emitter Voltage	$V_{BE}$	$V_{CE}=6.0\text{V}, I_C=1.0\text{mA}$ (Note 1)	0.55		0.7	V
Gain Bandwidth Product	$f_T$	$V_{CE}=6.0\text{V}, I_E=-10\text{mA}$		250		MHz
Output Capacitance	$C_{OB}$	$V_{CB}=6.0\text{V}, I_E=0, f=1.0\text{MHz}$		3.0		pF

Note: Pulsed:  $P_w \leq 350\mu\text{s}$ , Duty Cycle  $\leq 2\%$ .

■ CLASSIFICATION OF  $h_{FE}$

RANK	L4	L5	L6	L7
RANGE	90 ~ 180	135 ~ 270	200 ~ 400	300 ~ 600

## TYPICAL CHARACTERISTICS

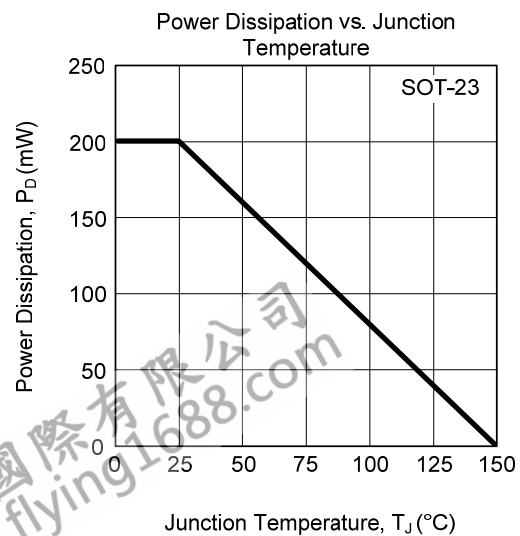
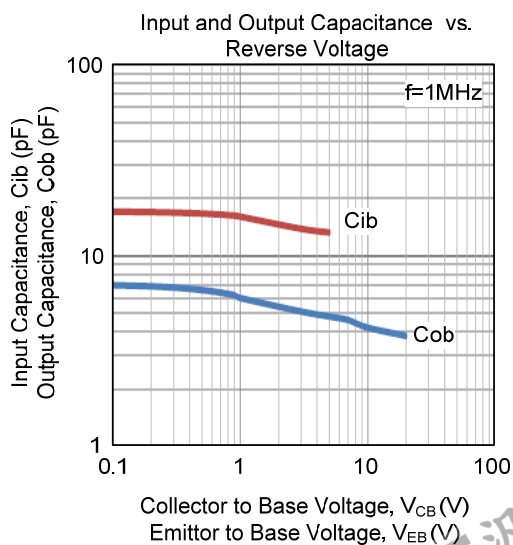
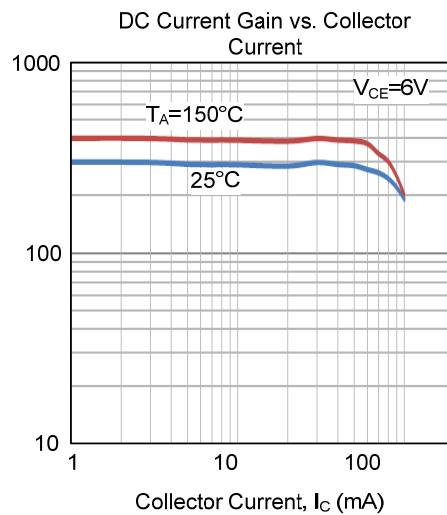
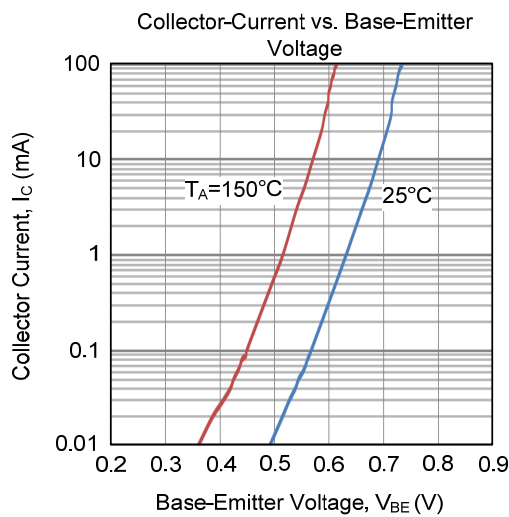
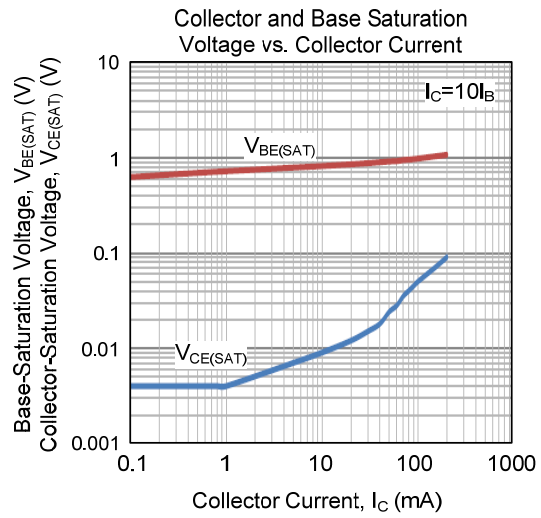
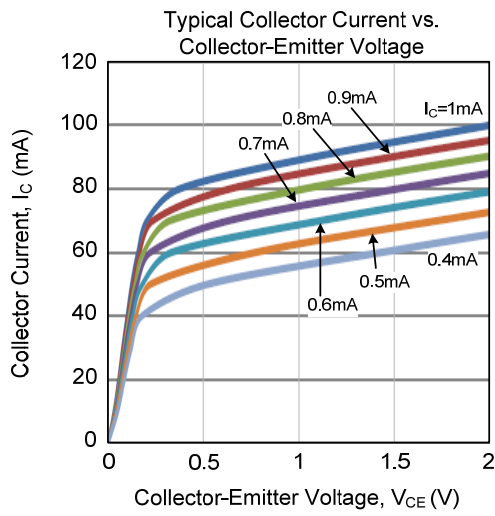

UTC assumes no responsibility for equipment failures that result from using products at values that exceed, even momentarily, rated values (such as maximum ratings, operating condition ranges, or other parameters) listed in products specifications of any and all UTC products described or contained herein. UTC products are not designed for use in life support appliances, devices or systems where malfunction of these products can be reasonably expected to result in personal injury. Reproduction in whole or in part is prohibited without the prior written consent of the copyright owner. UTC reserves the right to make changes to information published in this document, including without limitation specifications and product descriptions, at any time and without notice. This document supersedes and replaces all information supplied prior to the publication hereof.