



# 2SC2655

## NPN SILICON TRANSISTOR

POWER AMPLIFIER  
 APPLICATIONS POWER  
 SWITCHING APPLICATIONS

■ FEATURES

- \* Low saturation voltage:  $V_{CE(SAT)} = 0.5V$  (Max.)
- \* High speed switching time:  $T_{STG} = 1.0\mu s$  (Typ.)

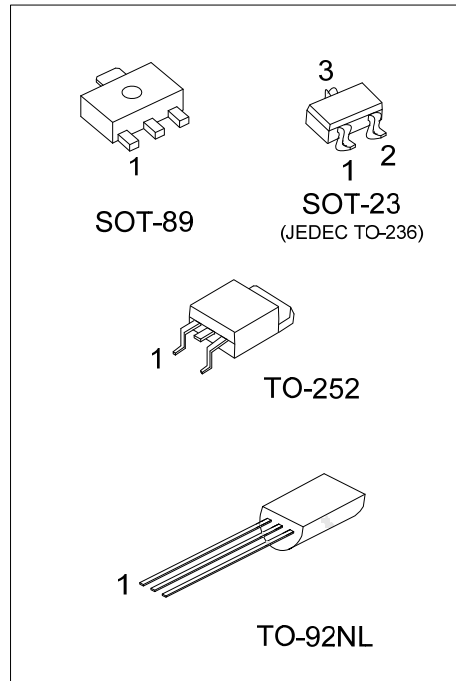

■ ORDERING INFORMATION

Ordering Number		Package	Pin Assignment			Packing
Lead Free	Halogen Free		1	2	3	
2SC2655L-x-AB3-R	2SC2655G-x-AB3-R	SOT-89	B	C	E	Tape Reel
2SC2655L-x-AE3-R	2SC2655G-x-AE3-R	SOT-23	B	E	C	Tape Reel
2SC2655L-x-TN3-R	2SC2655G-x-TN3-R	TO-252	B	C	E	Tape Reel
2SC2655L-x-T9N-B	2SC2655G-x-T9N-B	TO-92NL	E	C	B	Tape Box
2SC2655L-x-T9N-K	2SC2655G-x-T9N-K	TO-92NL	E	C	B	Bulk

Note: Pin Assignment: B: Base C: Collector E: Emitter

<p>2SC2655G-x-AB3-R</p>	<p>(1) B: Tape Box, K: Bulk, R: Tape Reel          (2) AB3: SOT-89, AE3: SOT-23, T9N: TO-92NL          TN3: TO-252          (3) refer to Classification of <math>h_{FE1}</math>          (4) G: Halogen Free and Lead Free, L: Lead Free</p>
-------------------------	--

■ MARKING

<p>SOT-23</p>	<p>SOT-89</p>
<p>TO-252</p>	<p>TO-92NL</p>

■ ABSOLUTE MAXIMUM RATINGS (T<sub>A</sub>= 25°C, unless otherwise specified)

PARAMETER		SYMBOL	RATING	UNIT
Collector-Base Voltage		V <sub>CBO</sub>	50	V
Collector-Emitter Voltage		V <sub>CEO</sub>	50	V
Emitter-Base Voltage		V <sub>EBO</sub>	5	V
Collector Current		I <sub>C</sub>	2	A
Collector Current (Pulse) (Note 2)		I <sub>CP</sub>	3	A
Base Current		I <sub>B</sub>	0.5	A
Collector Power Dissipation	SOT-23	P <sub>C</sub>	350	mW
	SOT-89		500	mW
	TO-252		1000	mW
	TO-92NL		900	mW
Junction Temperature		T <sub>J</sub>	+150	°C
Operating Temperature		T <sub>OPR</sub>	-40 ~ +150	°C
Storage Temperature		T <sub>STG</sub>	-55 ~ +150	°C

Notes: 1. Absolute maximum ratings are those values beyond which the device could be permanently damaged.

Absolute maximum ratings are stress ratings only and functional device operation is not implied.

2. P<sub>W</sub> ≤ 16ms, Duty Cycle ≤ 50%.

■ THERMAL DATA

PARAMETER		SYMBOL	RATINGS	UNIT
Junction to Ambient	SOT-23	θ <sub>JA</sub>	417	°C/W
	SOT-89		250	
	TO-252		75	
	TO-92NL		125	
Junction to Case	SOT-23	θ <sub>JC</sub>	208.3	°C/W
	SOT-89		156.3	
	TO-252		12.5	
	TO-92NL		83.3	

Note: Device mounted on FR-4 substrate P<sub>C</sub> board, 2oz copper, with 1inch square copper plate.

■ ELECTRICAL CHARACTERISTICS (T<sub>A</sub>= 25°C, unless otherwise specified)

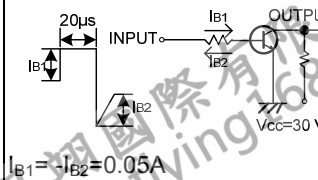
PARAMETER	SYMBOL	TEST CONDITIONS	MIN	TYP	MAX	UNIT
Collector to Base Breakdown Voltage	BV <sub>CBO</sub>	I <sub>C</sub> = 10μA, I <sub>E</sub> = 0	50			V
Collector to Emitter Breakdown Voltage	BV <sub>CEO</sub>	I <sub>C</sub> = 10mA, I <sub>B</sub> = 0	50			V
Emitter to Base Breakdown Voltage	BV <sub>EBO</sub>	I <sub>E</sub> = 10μA, I <sub>C</sub> = 0	5			V
Collector Cut-off Current	I <sub>CBO</sub>	V <sub>CB</sub> =50V, I <sub>E</sub> = 0			1.0	μA
Emitter Cut-off Current	I <sub>EBO</sub>	V <sub>EB</sub> = 5V, I <sub>C</sub> =0			1.0	μA
DC Current Gain	h <sub>FE1</sub>	V <sub>CE</sub> =2V, I <sub>C</sub> =0.5A	70		240	
	h <sub>FE2</sub>	V <sub>CE</sub> =2V, I <sub>C</sub> =1.5A	40			
Collector-Emitter Saturation Voltage	V <sub>CE(SAT)</sub>	I <sub>C</sub> =1A, I <sub>B</sub> =0.05A			0.5	V
Base- Emitter Saturation Voltage	V <sub>BE(SAT)</sub>	I <sub>C</sub> =1A, I <sub>B</sub> =0.05A			1.2	V
Transition Frequency	f <sub>T</sub>	V <sub>CE</sub> =2V, I <sub>C</sub> =0.5A		100		MHZ
Collector Output Capacitance	C <sub>OB</sub>	V <sub>CB</sub> = 10V, I <sub>E</sub> = 0, f=1MHZ		30		pF
Switching Time(Turn-on Time)	t <sub>ON</sub>	 <p>I<sub>B1</sub> = -I<sub>B2</sub> = 0.05A DUTY CYCLE ≤ 1%</p>		0.1		μS

■ CLASSIFICATION OF  $h_{FE1}$

RANK	O	Y
RANGE	70-140	120-240

## TYPICAL CHARACTERISTICS

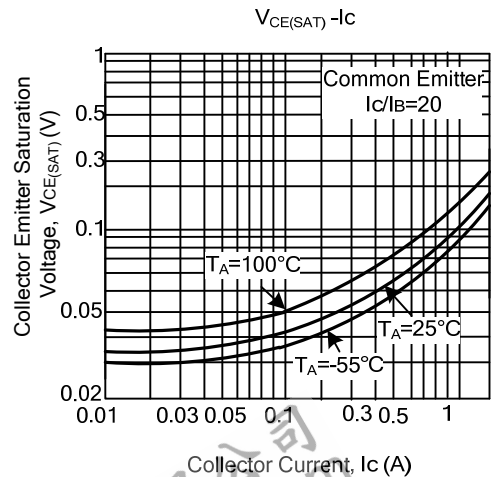
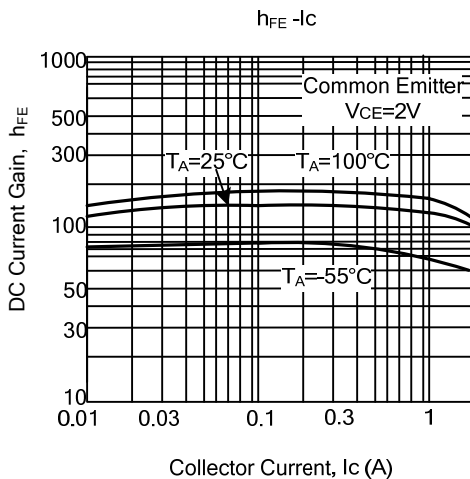
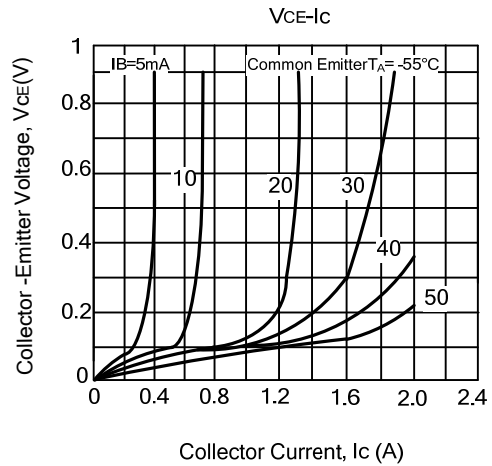
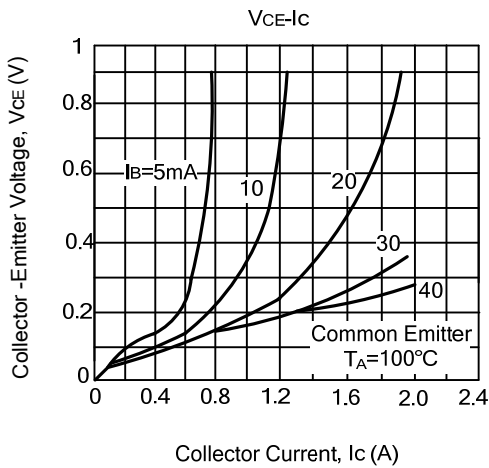
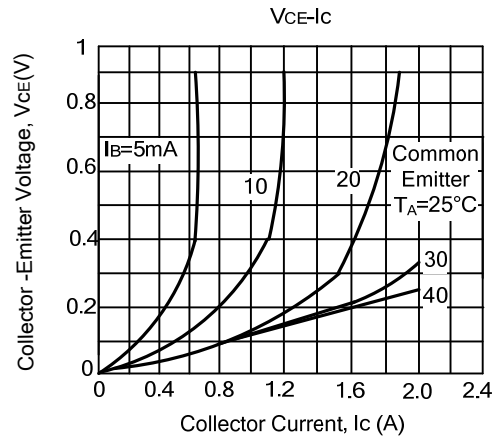
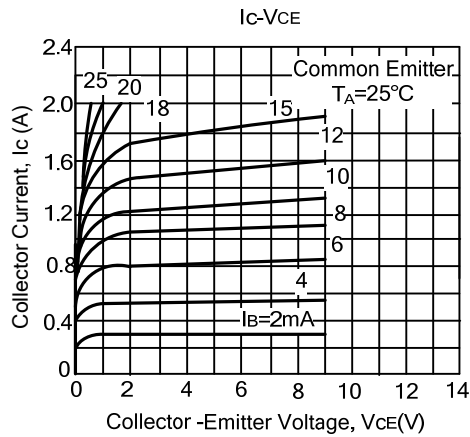

■ TYPICAL CHARACTERISTICS (Cont.)

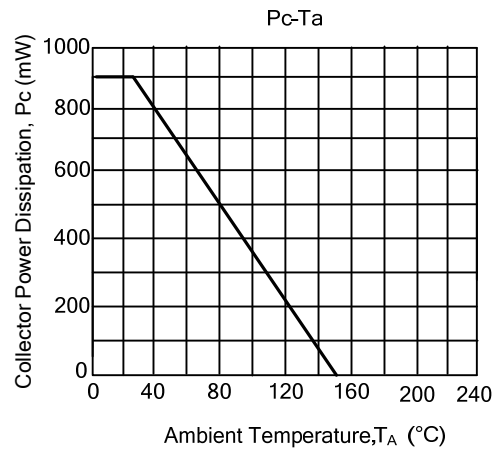
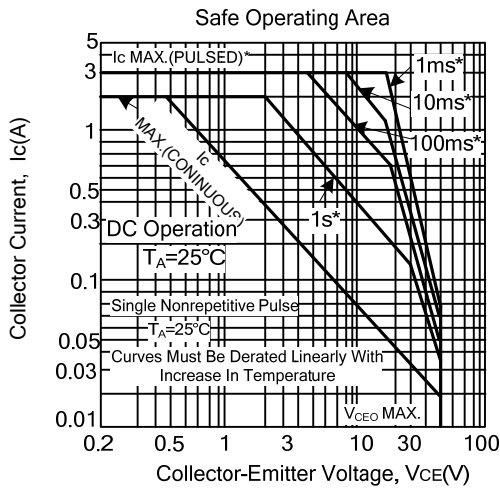
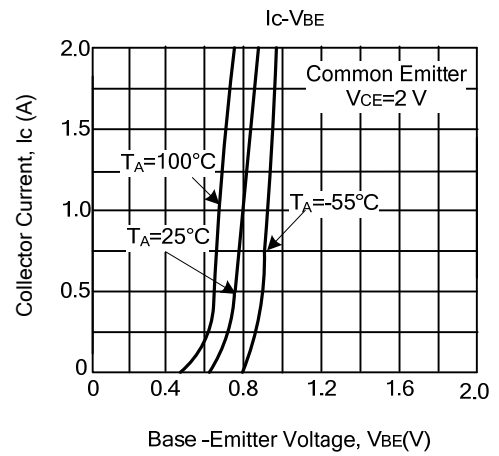
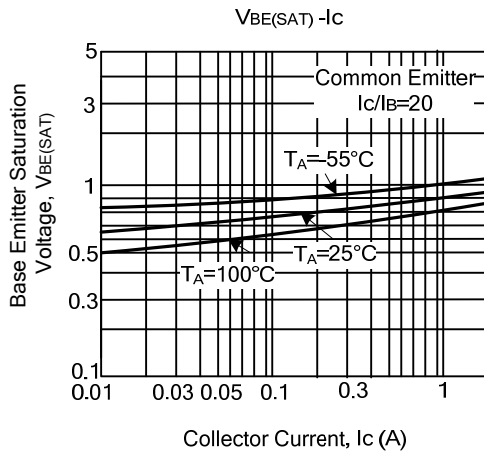

UTC assumes no responsibility for equipment failures that result from using products at values that exceed, even momentarily, rated values (such as maximum ratings, operating condition ranges, or other parameters) listed in products specifications of any and all UTC products described or contained herein. UTC products are not designed for use in life support appliances, devices or systems where malfunction of these products can be reasonably expected to result in personal injury. Reproduction in whole or in part is prohibited without the prior written consent of the copyright owner. UTC reserves the right to make changes to information published in this document, including without limitation specifications and product descriptions, at any time and without notice. This document supersedes and replaces all information supplied prior to the publication hereof.