



2SC3149

NPN SILICON TRANSISTOR

NPN TRANSISTOR

DESCRIPTION

The UTC **2SC3149** are series of NPN silicon planar transistor, and its suited to be used in power amplifier applications.

FEATURES

* Suit for power amplifier applications

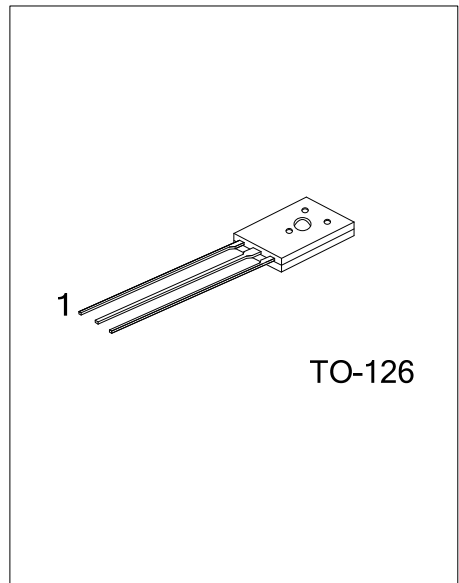

ORDERING INFORMATION

Ordering Number		Package	Pin Assignment			Packing
Lead Free	Halogen Free		1	2	3	
2SC3149L-T60-K	2SC3149G-T60-K	TO-126	B	C	E	Bulk

<p>2SC3149L-T60-K</p> <ul style="list-style-type: none"> (1) Packing Type (2) Package Type (3) Green Package 	<ul style="list-style-type: none"> (1) K: Bulk (2) T60: TO-126 (3) L: Lead Free, G: Halogen Free and Lead Free
---	---

MARKING

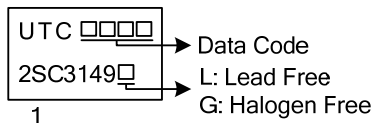

FLYING 汎翔國際有限公司
www.flying1688.com

■ ABSOLUTE MAXIMUM RATING

PARAMETER	SYMBOL	RATINGS	UNIT
Collector-Base Voltage	V_{CBO}	1200	V
Collector-emitter voltage	V_{CEO}	800	V
Emitter-Base Voltage	V_{EBO}	7	V
Collector Current	I_C	0.5	A
Collector Dissipation	P_C	2	W
Junction Temperature	T_J	+150	°C
Storage Temperature	T_{STG}	-55 ~ +150	°C

Note Absolute maximum ratings are those values beyond which the device could be permanently damaged.

Absolute maximum ratings are stress ratings only and functional device operation is not implied.

■ ELECTRICAL CHARACTERISTICS ($T_a=25^\circ\text{C}$, unless otherwise specified)

PARAMETER	SYMBOL	TEST CONDITIONS	MIN	TYP	MAX	UNIT
Collector-Base Breakdown Voltage	BV_{CBO}	$I_C=1\text{mA}$, $I_E=0\text{A}$	1200			V
Collector-Emitter Breakdown Voltage	BV_{CEO}	$I_C=5\text{mA}$, $I_B=0\text{A}$	800			V
Emitter-Base Breakdown Voltage	BV_{EBO}	$I_E=1\text{mA}$, $I_C=0\text{A}$	7			V
Collector Cutoff Current	I_{CBO}	$V_{CB}=800\text{V}$, $I_E=0\text{A}$			10	μA
Emitter Cutoff Current	I_{EBO}	$V_{EB}=5\text{V}$, $I_C=0\text{A}$			10	μA
DC Current Gain (Note)	h_{FE}	$I_C=100\text{mA}$, $V_{CE}=5\text{V}$	10		40	
Collector-Emitter Saturation Voltage	$V_{CE(SAT)}$	$I_C=200\text{mA}$, $I_B=40\text{mA}$			0.8	V
Base-Emitter Saturation Voltage	$V_{BE(SAT)}$	$I_C=200\text{mA}$, $I_B=40\text{mA}$			1.5	V
Current Gain Bandwidth Product	f_T	$I_C=100\text{mA}$, $V_{CE}=10\text{V}$		15		MHz
Output Capacitance	C_{OB}	$V_{CB}=10\text{V}$, $f=1\text{MHz}$		30		pF
Turn-On Time	t_{ON}	$I_C=1\text{A}$, $I_{B1}=0.2\text{A}$, $I_{B2}=-0.4\text{A}$, $R_L=400\Omega$, $V_{CC}=400\text{V}$			1.0	μs
Storage Time	t_{STG}				3.0	μs
Fall Time	t_F				0.7	μs

Note: Pulse test: Pulse width=300 μs , Duty Cycle \leq 2%

■ CLASSIFICATION OF h_{FE}

RANK	K	L	M
RANGE	10 ~ 20	15 ~ 30	20 ~ 40

TYPICAL CHARACTERISTICS

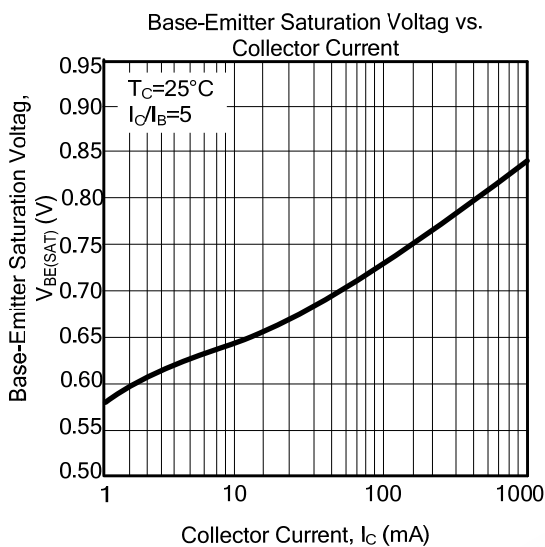
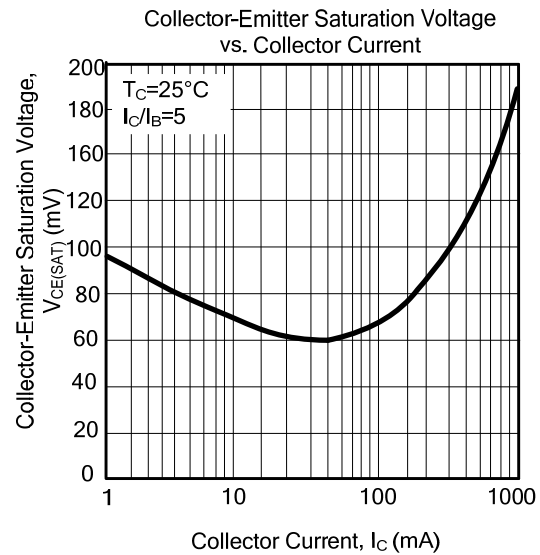
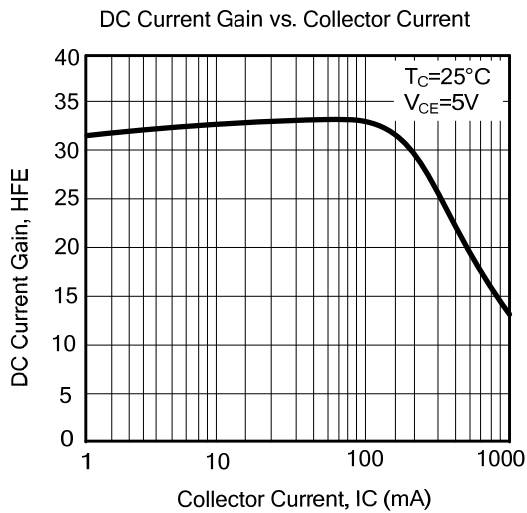
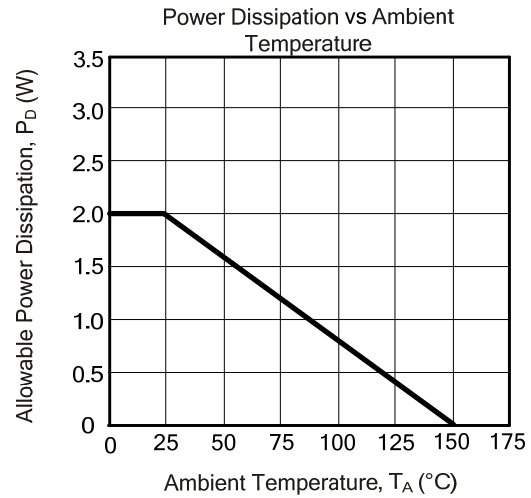
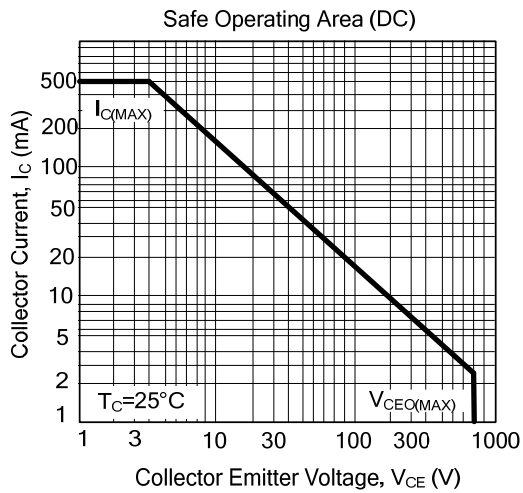

UTC assumes no responsibility for equipment failures that result from using products at values that exceed, even momentarily, rated values (such as maximum ratings, operating condition ranges, or other parameters) listed in products specifications of any and all UTC products described or contained herein. UTC products are not designed for use in life support appliances, devices or systems where malfunction of these products can be reasonably expected to result in personal injury. Reproduction in whole or in part is prohibited without the prior written consent of the copyright owner. The information presented in this document does not form part of any quotation or contract, is believed to be accurate and reliable and may be changed without notice.