



2SC3356

NPN SILICON TRANSISTOR

HIGH FREQUENCY LOW NOISE AMPLIFIER

■ DESCRIPTION

The UTC **2SC3356** is designed for such applications as: DC/DC converters, supply line switching, battery charger, LCD backlighting, peripheral drivers, Driver in low supply voltage applications (e.g. lamps and LEDs) and inductive load driver (e.g. relays, buzzers and motors).

■ FEATURES

- * Low Noise and High Gain
- * High Power Gain

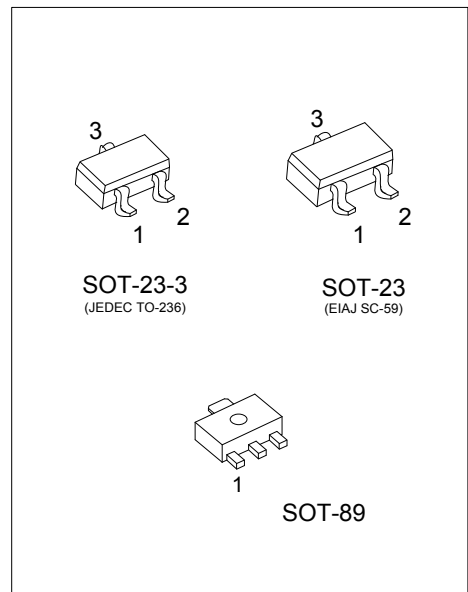

■ ORDERING INFORMATION

Ordering Number		Package	Pin Description			Packing
Lead Free	Halogen Free		1	2	3	
2SC3356L-x-AE2-R	2SC3356G-x-AE2-R	SOT-23-3	B	E	C	Tape Reel
2SC3356L-x-AE3-R	2SC3356G-x-AE3-R	SOT-23	B	E	C	Tape Reel
2SC3356L-x-AB3-R	2SC3356G-x-AB3-R	SOT-89	B	C	E	Tape Reel

Note: Pin Assignment: B: Base E: Emitter C: Collector

<p>2SC3356G-x-AE2-R</p> <p>(1) Packing Type (2) Package Type (3) Rank (4) Green Package</p>	<p>(1) R: Tape Reel (2) AE2: SOT-23-3, AE3: SOT-23 (3) x: refer to Classification of h_{FE} (4) G: Halogen Free and Lead Free, L: Lead Free</p>
---	---

■ MARKING

SOT-23-3/SOT-23		SOT-89
2SC3356L	2SC3356G	



■ ABSOLUTE MAXIMUM RATING

PARAMETER		SYMBOL	RATINGS	UNIT
Collector to Base Voltage		BV_{CBO}	20	V
Collector to Emitter Voltage		BV_{CEO}	12	V
Emitter to Base Voltage		BV_{EBO}	3	V
Collector Current		I_C	100	mA
Power Dissipation	SOT-23-3	P_D	200	mW
	SOT-23			
	SOT-89		500	mW
Junction Temperature		T_J	+150	°C
Storage Temperature		T_{STG}	-65 ~ +150	°C

Note: Absolute maximum ratings are those values beyond which the device could be permanently damaged. Absolute maximum ratings are stress ratings only and functional device operation is not implied.

■ ELECTRICAL CHARACTERISTICS ($T_a=25^\circ\text{C}$, unless otherwise specified)

PARAMETER	SYMBOL	TEST CONDITIONS	MIN	TYP	MAX	UNIT
Collector to Base Breakdown Voltage	BV_{CBO}	$I_C=10\mu\text{A}, I_E=0$	20			V
Collector to Emitter Breakdown Voltage	BV_{CEO}	$I_C=1\text{mA}, R_{BE}=\infty$	12			V
Emitter to Base Breakdown Voltage	BV_{EBO}	$I_E=10\mu\text{A}, I_C=0$	3			V
Collector-Base Cut-Off Current	I_{CBO}	$V_{CB}=10\text{V}, I_E=0$			1.0	μA
Emitter-Base Cut-Off Current	I_{EBO}	$V_{EB}=1\text{V}, I_C=0$			1.0	μA
DC Current Gain	h_{FE}	$V_{CE}=10\text{V}, I_C=20\text{mA}$	50		300	
Gain Bandwidth Product	f_T	$V_{CE}=10\text{V}, I_C=20\text{mA}$		7		GHz
Feed-Back Capacitance	C_{RE}	$V_{CB}=10\text{V}, I_E=0, f=1.0\text{MHz}$			1.0	pF
Noise Figure	NF	$V_{CE}=10\text{V}, I_C=7\text{mA}, f=1.0\text{GHz}$			2.0	dB

■ CLASSIFICATION OF h_{FE}

RANK	A	B
RANGE	50-170	160-300

TYPICAL CHARACTERISTICS

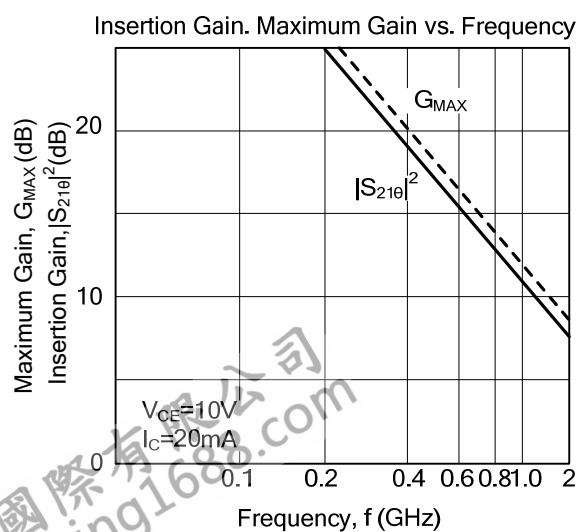
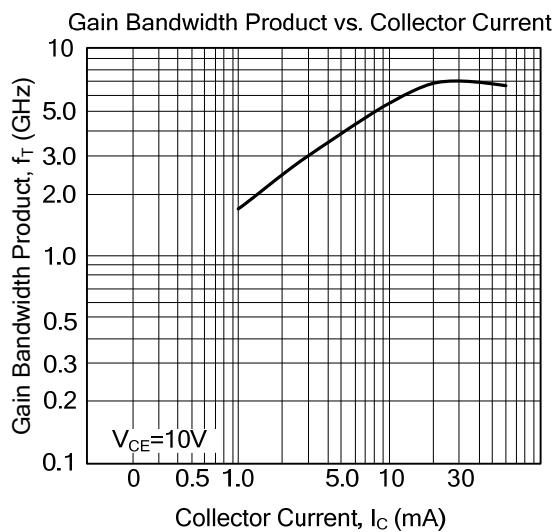
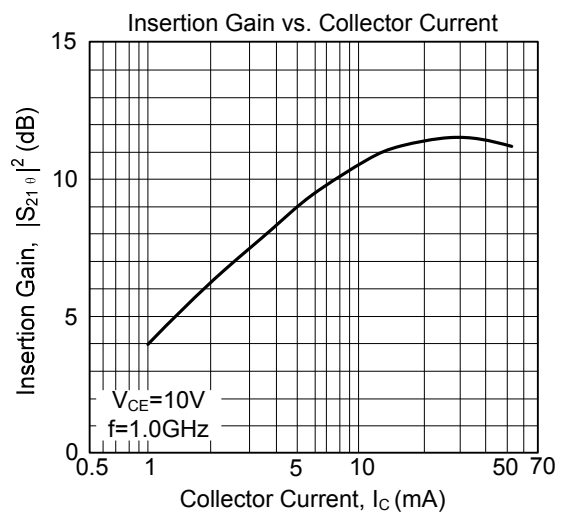
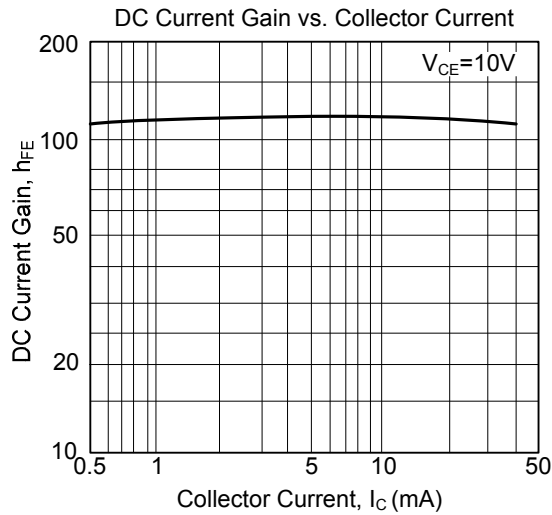
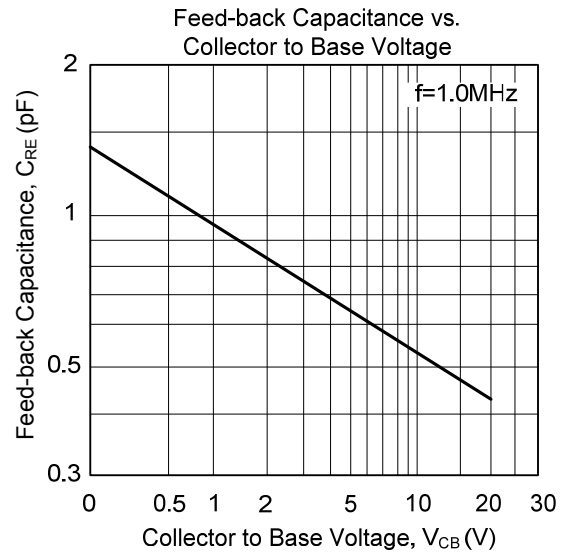
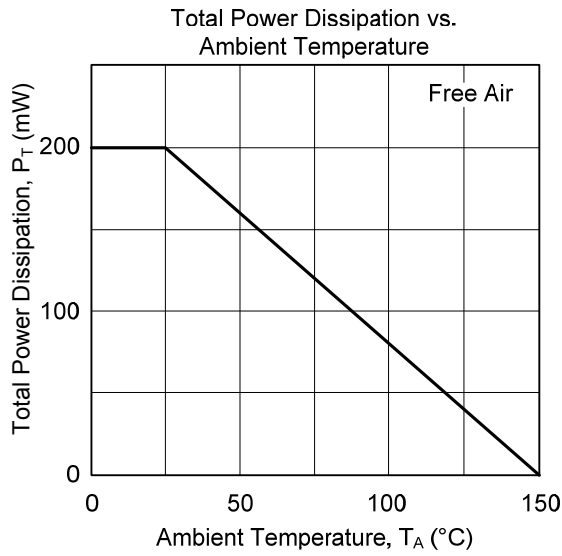

■ TYPICAL CHARACTERISTICS (Cont.)

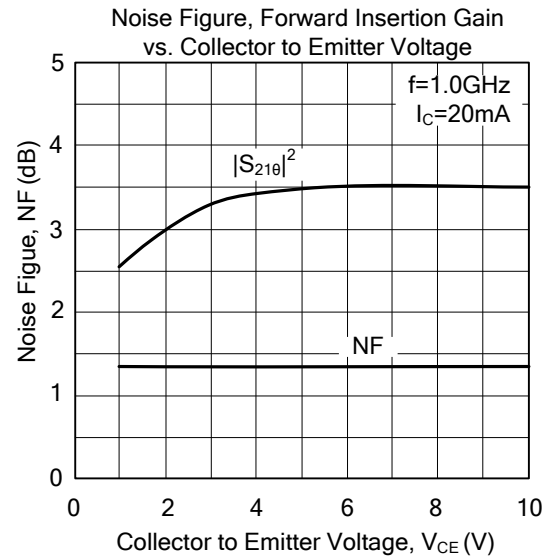
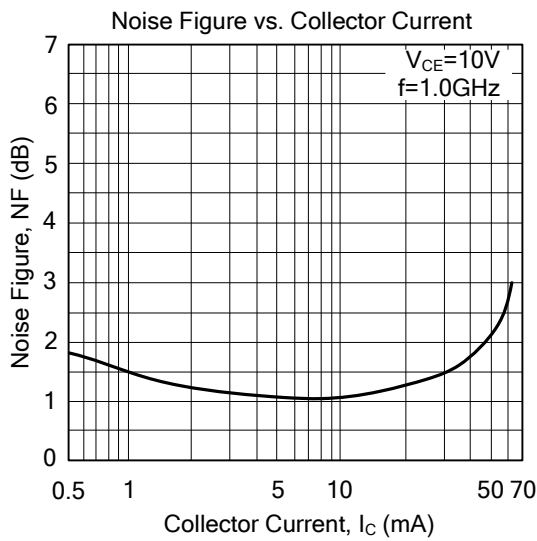

UTC assumes no responsibility for equipment failures that result from using products at values that exceed, even momentarily, rated values (such as maximum ratings, operating condition ranges, or other parameters) listed in products specifications of any and all UTC products described or contained herein. UTC products are not designed for use in life support appliances, devices or systems where malfunction of these products can be reasonably expected to result in personal injury. Reproduction in whole or in part is prohibited without the prior written consent of the copyright owner. UTC reserves the right to make changes to information published in this document, including without limitation specifications and product descriptions, at any time and without notice. This document supersedes and replaces all information supplied prior to the publication hereof.