



2SC3647

NPN SILICON TRANSISTOR

HIGH-VOLTAGE SWITCHING APPLICATIONS

FEATURES

- * High breakdown voltage and large current capacity
- * Fast switching time
- * Very small size marking it easy to provide high – density, small-sized hybrid ICs

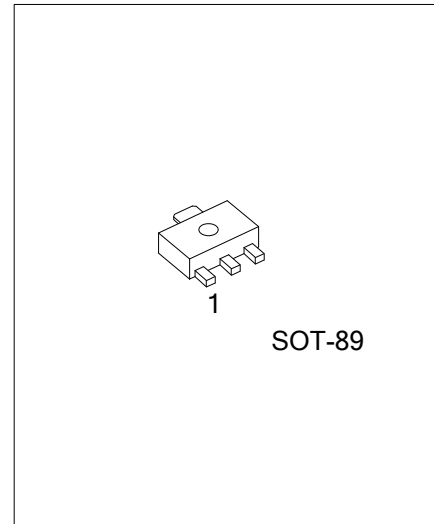

ORDERING INFORMATION

Ordering Number	Package	Pin Assignment			Packing
		1	2	3	
2SC3647G-x-AB3-R	SOT-89	B	C	E	Tape Reel

Note: Pin Assignment: B: Base C: Collector E: Emitter

<p>2SC3647G-x-AB3-R</p>	<p>(1) R: Tape Reel</p> <p>(2) AB3: SOT-89</p> <p>(3) x: refer to Classification of h_{FE}</p> <p>(4) G: Halogen Free and Lead Free</p>
-------------------------	--

MARKING

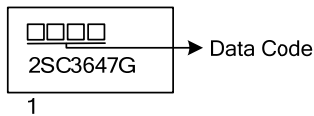

FLYING 汎翔國際有限公司
 www.flying1688.com

■ ABSOLUTE MAXIMUM RATINGS ($T_A = 25^\circ\text{C}$, unless otherwise specified)

PARAMETER	SYMBOL	RATINGS	UNIT
Collector to Base Voltage	V_{CB0}	120	V
Collector to Emitter Voltage	V_{CEO}	100	V
Emitter to Base Voltage	V_{EBO}	6	V
Collector Current	I_C	2	A
Collector Current (Pulse)	I_{CP}	3	A
Collector Dissipation	P_C	500	mW
Junction Temperature	T_J	150	$^\circ\text{C}$
Storage Temperature	T_{STG}	-40 ~ +150	$^\circ\text{C}$

Note: Absolute maximum ratings are those values beyond which the device could be permanently damaged.

Absolute maximum ratings are stress ratings only and functional device operation is not implied.

■ ELECTRICAL CHARACTERISTICS ($T_A = 25^\circ\text{C}$, unless otherwise specified)

PARAMETER	SYMBOL	TEST CONDITIONS	MIN	TYP	MAX	UNIT
Collector-Base Breakdown Voltage	BV_{CB0}	$I_C = 10\mu\text{A}$, $I_E = 0$	120			V
Collector-Emitter Breakdown Voltage	BV_{CEO}	$I_C = 1\text{mA}$, $R_{BE} = \infty$	100			V
Emitter-Base Breakdown Voltage	BV_{EBO}	$I_E = 10\mu\text{A}$, $I_C = 0$	6			V
Collector Cutoff Current	I_{CBO}	$V_{CB} = 100\text{V}$, $I_E = 0$			100	nA
Emitter Cutoff Current	I_{EBO}	$V_{EB} = 4\text{V}$, $I_C = 0$			100	nA
Collector-Emitter Saturation Voltage	$V_{CE(SAT)}$	$I_C = 1\text{A}$, $I_B = 100\text{mA}$		0.13	0.4	V
Base-Emitter Saturation Voltage	$V_{BE(SAT)}$	$I_C = 1\text{A}$, $I_B = 100\text{mA}$		0.85	1.2	V
Output Capacitance	C_{ob}	$V_{CB} = 10\text{V}$, $f = 1\text{MHz}$		16		pF
DC Current Gain	h_{FE}	$V_{CE} = 5\text{V}$, $I_C = 100\text{mA}$	100		400	
Turn-ON Time	t_{ON}	See specified Test Circuit.		80		ns
Storage Time	t_{STG}	See specified Test Circuit.		1000		ns
Fall Time	t_F	See specified Test Circuit.		50		ns
Gain-Bandwidth Product	f_T	$V_{CE} = 10\text{V}$, $I_C = 100\text{mA}$		120		MHz

■ CLASSIFICATION OF h_{FE}

RANK	R	S	T
RANGE	100 ~ 200	140 ~ 280	200 ~ 400

■ SWITCHING TIME TEST CIRCUIT

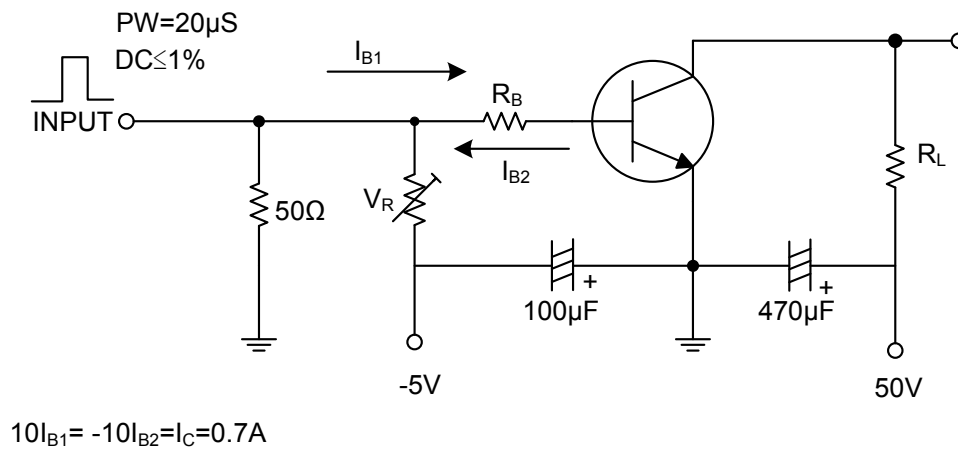

■ TYPICAL CHARACTERISTICS

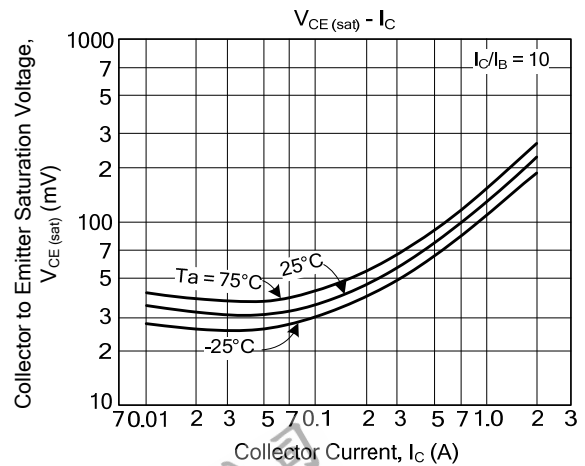
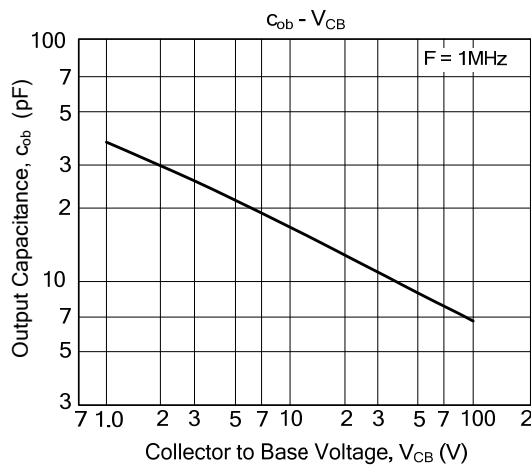
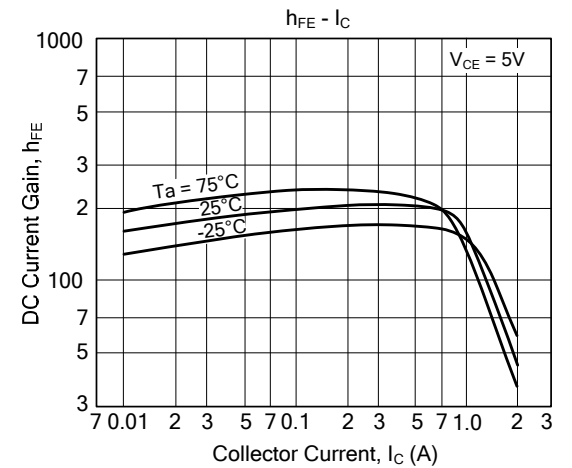
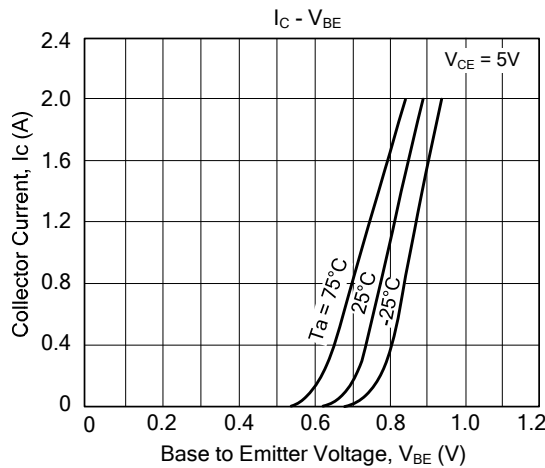
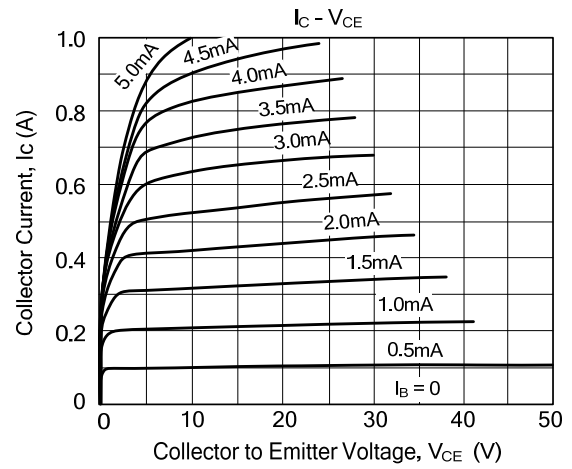
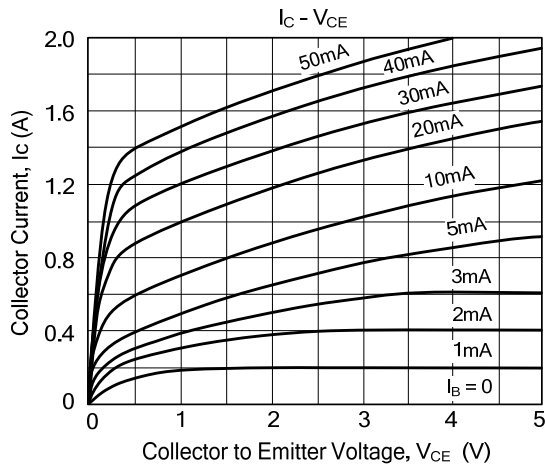

TYPICAL CHARACTERISTICS(Cont.)

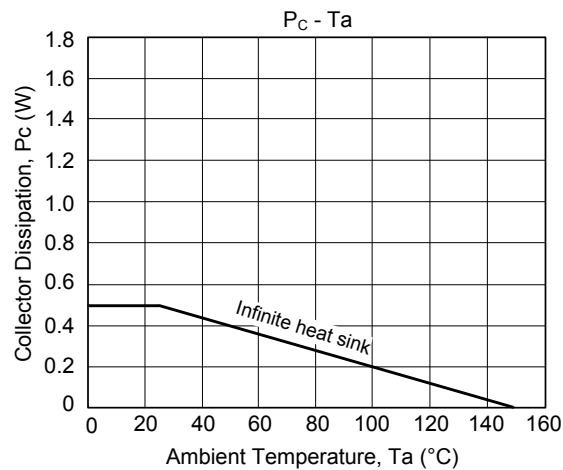
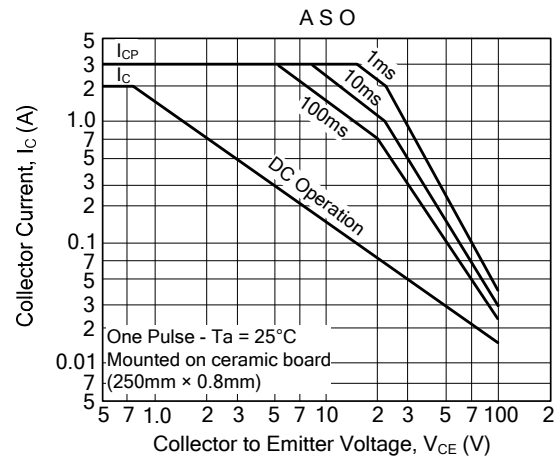
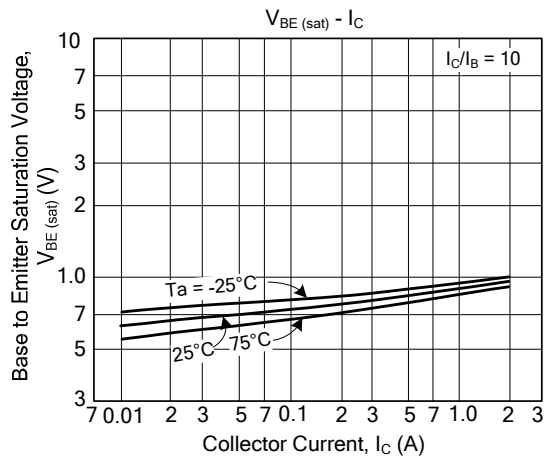

UTC assumes no responsibility for equipment failures that result from using products at values that exceed, even momentarily, rated values (such as maximum ratings, operating condition ranges, or other parameters) listed in products specifications of any and all UTC products described or contained herein. UTC products are not designed for use in life support appliances, devices or systems where malfunction of these products can be reasonably expected to result in personal injury. Reproduction in whole or in part is prohibited without the prior written consent of the copyright owner. The information presented in this document does not form part of any quotation or contract, is believed to be accurate and reliable and may be changed without notice.