



## 2SC4793

## NPN SILICON TRANSISTOR

### NPN SILICON TRANSISTOR

#### FEATURES

- \*High transition frequency
- \*Power amplifier applications
- \*Driver stage amplifier applications

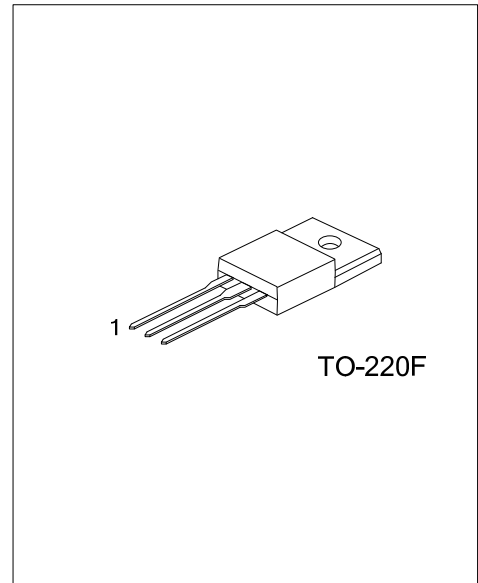

#### ORDERING INFORMATION

Order Number		Package	Pin Assignment			Packing
Lead Free	Halogen Free		1	2	3	
2SC4793L-x-TF3-T	2SC4793G-x-TF3-T	TO-220F	B	C	E	Tube

Note: Pin Assignment: B: Base C: Collector E: Emitter

<p>2C4793L-x-TF3-T</p>	<p>(1) Packing Type</p> <p>(2) Package Type</p> <p>(3) Rank</p> <p>(4) Green Package</p>	<p>(1) T: Tube</p> <p>(2) TF3: TO-220F</p> <p>(3) refer to Classification of <math>h_{FE}</math></p> <p>(4) L: Lead Free, G: Halogen Free and Lead Free</p>
------------------------	--	---

#### MARKING

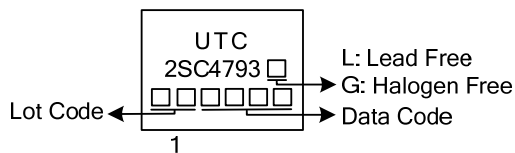

■ ABSOLUTE MAXIMUM RATINGS ( $T_A=25^\circ\text{C}$ )

PARAMETER	SYMBOL	RATINGS	UNIT	
Collector-Base Voltage	$V_{CBO}$	230	V	
Collector-Emitter Voltage	$V_{CEO}$	230	V	
Emitter-Base Voltage	$V_{EBO}$	5	V	
Collector Current	$I_C$	1	A	
Base Current	$I_B$	0.1	A	
Collector Power Dissipation	$P_C$	$T_A=25^\circ\text{C}$	2.0	W
		$T_C=25^\circ\text{C}$	20	W
Junction Temperature	$T_J$	+150	$^\circ\text{C}$	
Storage Temperature Range	$T_{STG}$	-55 ~ +150	$^\circ\text{C}$	

Note: Absolute maximum ratings are those values beyond which the device could be permanently damaged. Absolute maximum ratings are stress ratings only and functional device operation is not implied.

■ ELECTRICAL CHARACTERISTICS ( $T_a=25^\circ\text{C}$ , unless others specified)

PARAMETER	SYMBOL	TEST CONDITIONS	MIN	TYP	MAX	UNIT
Collector-Emitter Breakdown Voltage	$BV_{CEO}$	$I_C=10\text{mA}$ , $I_B=0$	230			V
Base -Emitter Voltage	$V_{BE}$	$V_{CE}=5\text{V}$ , $I_C=500\text{mA}$			1.0	V
Collector-Emitter Saturation Voltage	$V_{CE(SAT)}$	$I_C=500\text{mA}$ , $I_B=50\text{mA}$			1.5	V
Collector Cut-off Current	$I_{CBO}$	$V_{CB}=230\text{V}$ , $I_E=0$			1.0	$\mu\text{A}$
Emitter Cut-off Current	$I_{EBO}$	$V_{EB}=5\text{V}$ , $I_C=0$			1.0	$\mu\text{A}$
DC Current Gain	$h_{FE}$	$V_{CE}=5\text{V}$ , $I_C=100\text{mA}$	100		320	
Transition Frequency	$f_T$	$V_{CE}=10\text{V}$ , $I_C=100\text{mA}$		100		MHz
Collector Output Capacitance	$C_{ob}$	$V_{CB}=10\text{V}$ , $I_E=0$ , $f=1\text{MHz}$		20		pF

■ CLASSIFICATION OF  $h_{FE}$

RANK	A	B
RANGE	100-200	180-320

## TYPICAL CHARACTERISTICS

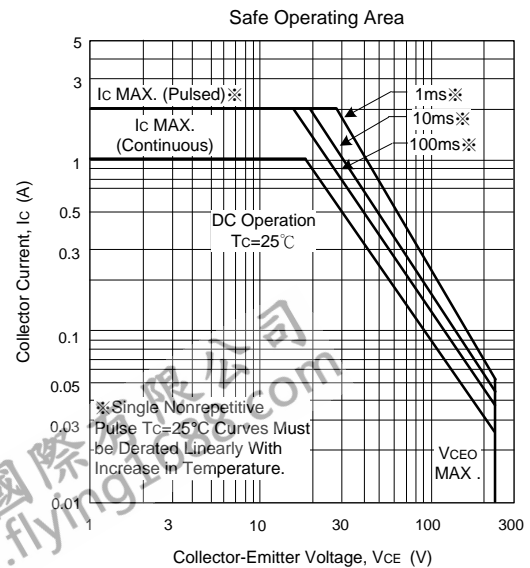
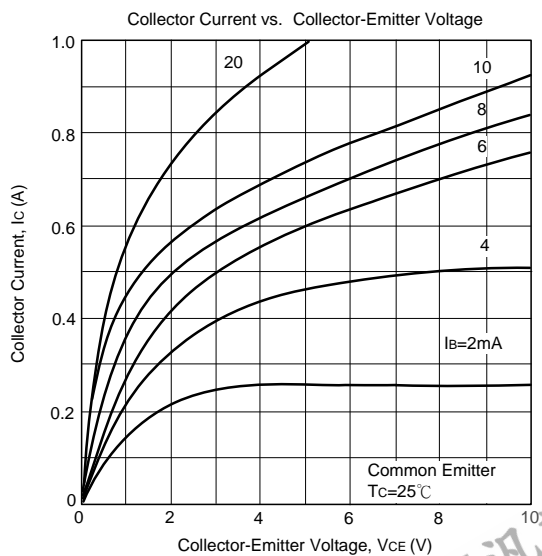
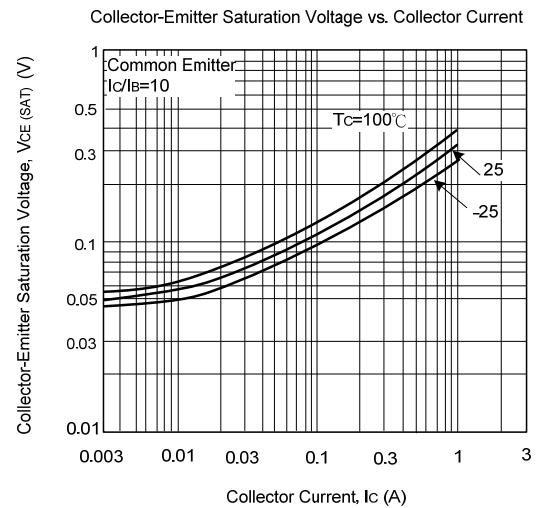
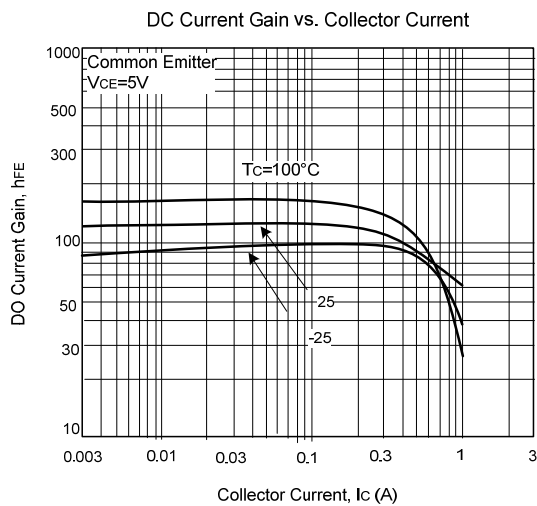
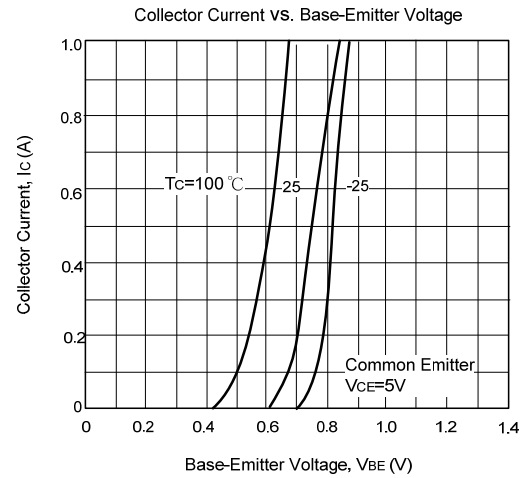
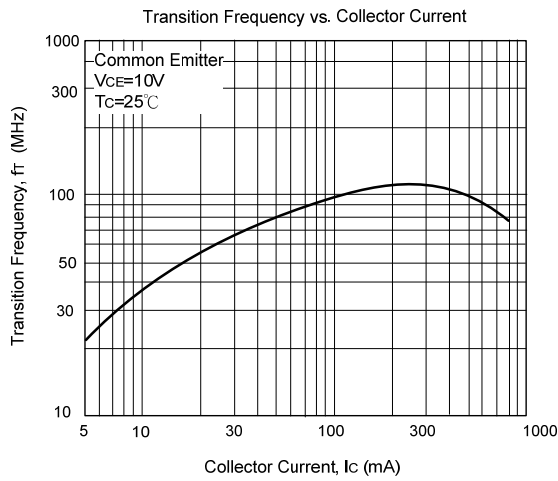

UTC assumes no responsibility for equipment failures that result from using products at values that exceed, even momentarily, rated values (such as maximum ratings, operating condition ranges, or other parameters) listed in products specifications of any and all UTC products described or contained herein. UTC products are not designed for use in life support appliances, devices or systems where malfunction of these products can be reasonably expected to result in personal injury. Reproduction in whole or in part is prohibited without the prior written consent of the copyright owner. The information presented in this document does not form part of any quotation or contract, is believed to be accurate and reliable and may be changed without notice.