



2SC5765

NPN EPITAXIAL SILICON TRANSISTOR

MEDIUM POWER AMPLIFIER STROBO FLASH

DESCRIPTION

medium power amplifier applications
strobo flash applications

FEATURES

* Low Saturation Voltage: $V_{CE(sat)} = 0.27 \text{ V (max.)}$,
($I_c = 3\text{A} / I_B = 60 \text{ mA}$)

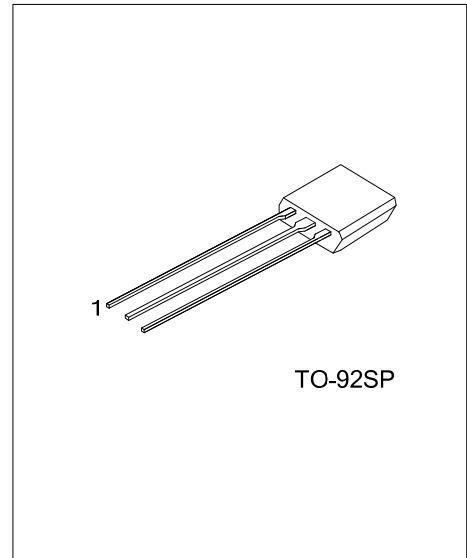

ORDERING INFORMATION

Ordering Number		Package	Pin Assignment			Packing
Lead Free	Halogen Free		1	2	3	
2SC5765L-T9S-K	2SC5765G-T9S-K	TO-92SP	E	C	B	Bulk

Note: Pin Assignment: E: Emitter C: Collector B: Base

<p>2SC5765L-T9K-R</p> <p>(1) Packing Type</p> <p>(2) Package Type</p> <p>(3) Green Package</p>	<p>(1) K: Bulk</p> <p>(2) T9S: TO-92SP</p> <p>(3) L: Lead Free, G: Halogen Free and Lead Free</p>
--	---

MARKING

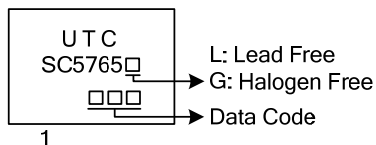

■ ABSOLUTE MAXIMUM RATING ($T_A=25^{\circ}\text{C}$)

PARAMETER		SYMBOL	RATINGS	UNIT
Collector-Base Voltage		V_{CBO}	15	V
Collector-Emitter Voltage		V_{CEO}	10	V
Emitter-Base Voltage		V_{EBO}	7	V
Collector Current	DC	I_C	5	A
	Plused		9	A
Collector Power Dissipation (Note 2)		P_C	550	mW
Junction Temperature		T_J	150	$^{\circ}\text{C}$
Storage Temperature		T_{STG}	-55 ~ +150	$^{\circ}\text{C}$

Notes: 1. Absolute maximum ratings are those values beyond which the device could be permanently damaged.

Absolute maximum ratings are stress ratings only and functional device operation is not implied.

2. When a device is mounted on a glass epoxy board (35 mm×30 mm×1mm)

■ ELECTRICAL CHARACTERISTICS ($T_A=25^{\circ}\text{C}$, unless otherwise specified)

PARAMETER	SYMBOL	TEST CONDITIONS	MIN	TYP	MAX	UNIT
Collector-Emitter Breakdown Voltage	BV_{CEO}	$I_C=1\text{mA}$, $I_B=0$	10			V
Collector Cut-Off Current	I_{CBO}	$V_{CB}=15\text{V}$, $I_E=0$			0.1	μA
Emitter Cut-Off Current	I_{EBO}	$V_{EB}=5\text{V}$, $I_C=0$			0.1	μA
DC Current Gain (Note)	h_{FE1}	$V_{CE}=1.5\text{V}$, $I_C=0.5\text{A}$	450		700	
	h_{FE2}	$V_{CE}=1.5\text{V}$, $I_C=2\text{A}$	320			
	h_{FE3}	$V_{CE}=1.5\text{V}$, $I_C=5\text{A}$	170			
Collector-Emitter Saturation Voltage (Note)	$V_{CE(SAT)}$	$I_C=3\text{A}$, $I_B=60\text{mA}$			0.27	V
Collector Output Capacitance	C_{ob}	$V_{CB}=10\text{V}$, $I_E=0$, $f=1\text{MHz}$		25		pF

Note: Pulse test

■ TYPICAL CHARACTERISTICS

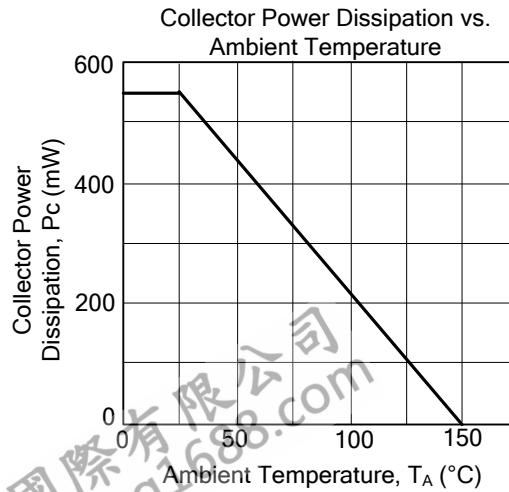
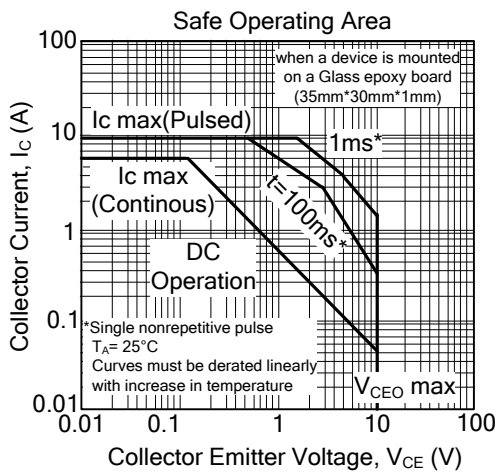
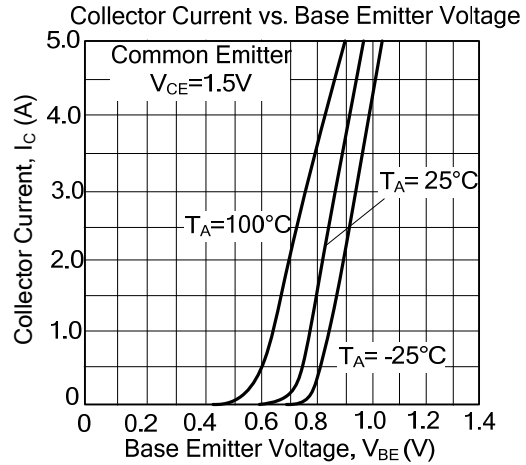
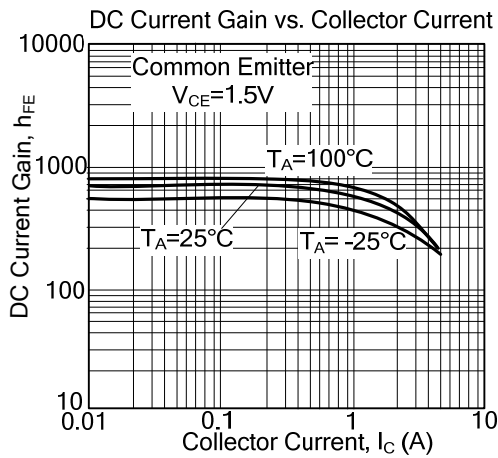
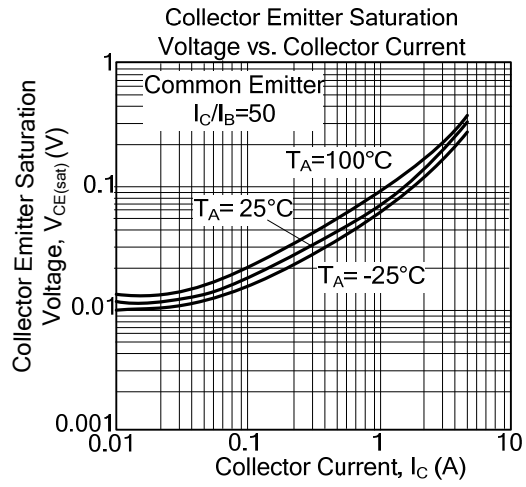
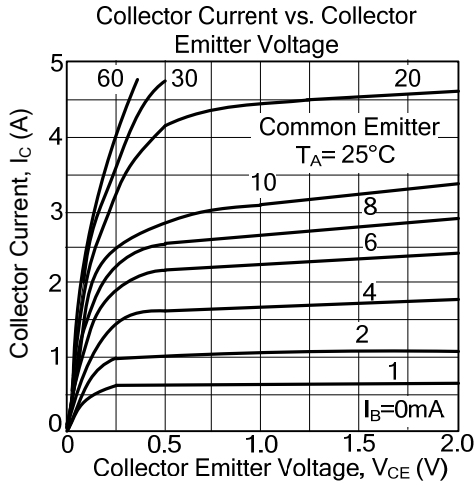

■ TYPICAL CHARACTERISTICS

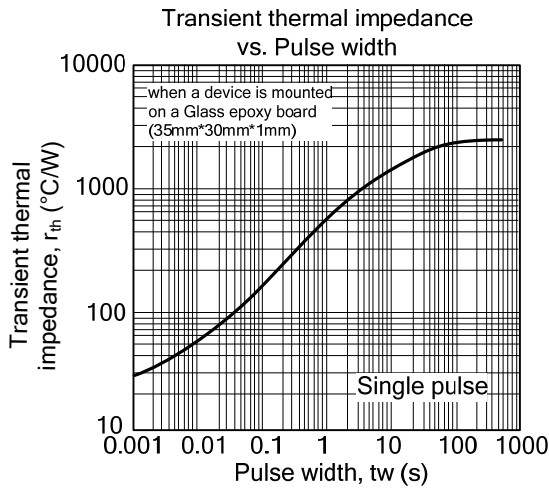

UTC assumes no responsibility for equipment failures that result from using products at values that exceed, even momentarily, rated values (such as maximum ratings, operating condition ranges, or other parameters) listed in products specifications of any and all UTC products described or contained herein. UTC products are not designed for use in life support appliances, devices or systems where malfunction of these products can be reasonably expected to result in personal injury. Reproduction in whole or in part is prohibited without the prior written consent of the copyright owner. The information presented in this document does not form part of any quotation or contract, is believed to be accurate and reliable and may be changed without notice.