



## 2SD2136

## NPN SILICON TRANSISTOR

### POWER TRANSISTOR

#### DESCRIPTION

The UTC **2SD2136** is designed for power application.

#### FEATURES

- \* High forward current transfer ratio  $h_{FE}$  which has satisfactory linearity.
- \* Low collector to emitter saturation voltage  $V_{CE(SAT)}$ .
- \* Allowing supply with the radial taping.

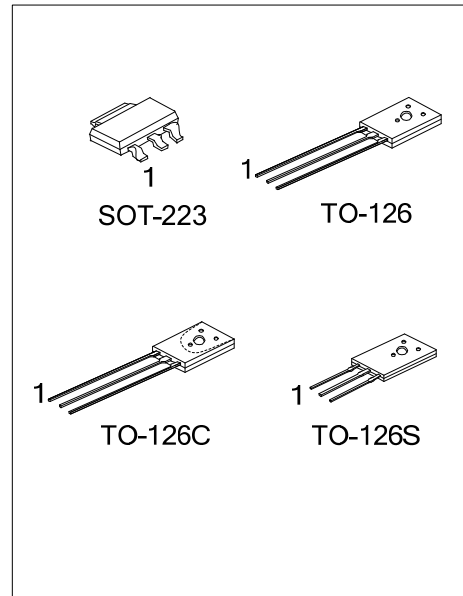

#### ORDERING INFORMATION

Ordering Number		Package	Pin Assignment			Packing
Lead Free	Halogen Free		1	2	3	
-	2SD2136G-x-AA3-R	SOT-223	B	C	E	Tape Reel
2SD2136L-x-T60-K	2SD2136G-x-T60-K	TO-126	B	C	E	Bulk
2SD2136L-x-T6C-K	2SD2136G-x-T6C-K	TO-126C	B	C	E	Bulk
2SD2136L-x-T6S-K	2SD2136G-x-T6S-K	TO-126S	B	C	E	Bulk

Note: Pin assignment: E: Emitter B: Base C: Collector

<p>2SD2136G-x-AA3-R</p>	<p>(1) K: Bulk  (2) AA3: SOT-223T60: TO-126, T6C: TO-126C  T6S: TO-126S  (3) x: Refer to Classification of <math>h_{FE1}</math>  (4) L: Lead Free, G: Halogen Free</p>
-------------------------	--

#### MARKING

SOT-223	TO-126 / TO-126C / TO-126S



■ ABSOLUTE MAXIMUM RATINGS (T<sub>A</sub>=25°C, unless otherwise specified )

PARAMETER		SYMBOL	RATINGS	UNIT
Collector-Base Voltage		V <sub>CBO</sub>	60	V
Collector-Emitter Voltage		V <sub>CEO</sub>	60	V
Emitter-Base Voltage		V <sub>EBO</sub>	6	V
Collector Current		I <sub>C</sub>	3	A
Peak Collector Current		I <sub>CP</sub>	5	A
Collector Dissipation	SOT-223	P <sub>C</sub>	1	W
	TO-126/TO-126C		1.5	W
	TO-126S			
Junction Temperature		T <sub>J</sub>	150	°C
Storage Temperature		T <sub>STG</sub>	-55 ~ +150	°C

Note: Absolute maximum ratings are those values beyond which the device could be permanently damaged. Absolute maximum ratings are stress ratings only and functional device operation is not implied.

■ ELECTRICAL CHARACTERISTICS (T<sub>A</sub>=25°C, unless otherwise specified )

PARAMETER	SYMBOL	TEST CONDITIONS	MIN	TYP	MAX	UNIT
Collector-Base Breakdown Voltage	BV <sub>CEO</sub>	I <sub>C</sub> =30mA, I <sub>B</sub> =0	60			V
Collect Cutoff Current	I <sub>CEO</sub>	V <sub>CE</sub> =60V, I <sub>B</sub> =0			300	μA
Collect Cutoff Current	I <sub>CES</sub>	V <sub>CE</sub> =60 V, V <sub>BE</sub> =0			200	μA
Emitter Cutoff Current	I <sub>EBO</sub>	V <sub>EB</sub> =6 V, I <sub>C</sub> =0			1	mA
DC Current Gain	h <sub>FE1</sub>	V <sub>CE</sub> =4V, I <sub>C</sub> =1A	40		250	
	h <sub>FE2</sub>	V <sub>CE</sub> =4V, I <sub>C</sub> =3A	10			
Collector-Emitter Saturation Voltage	V <sub>CE(SAT)</sub>	I <sub>C</sub> =3A, I <sub>B</sub> =0.375A			1.2	V
Base-Emitter Voltage	V <sub>BE</sub>	V <sub>CE</sub> =4V, I <sub>C</sub> =3A			1.8	V
Current Gain Bandwidth Product	f <sub>T</sub>	V <sub>CE</sub> =15V, I <sub>E</sub> =0.1A, f =200MHz		220		MHz
Turn On Time	t <sub>ON</sub>	I <sub>C</sub> = 1A, I <sub>B1</sub> =0.1A, I <sub>B2</sub> =0.1A		0.5		μS
Storage Time	t <sub>S</sub>			2.5		μS
Fall Time	t <sub>F</sub>			0.4		μS

■ CLASSIFICATION OF h<sub>FE1</sub>

RANK	P	Q	R
RANGE	40-90	70-150	120-250

## TYPICAL CHARACTERISTICS

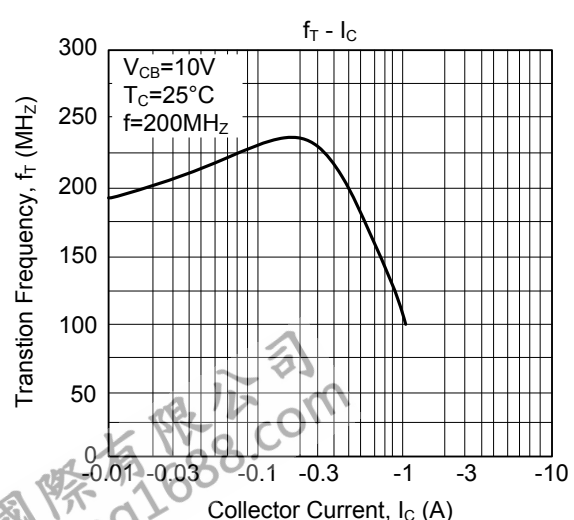
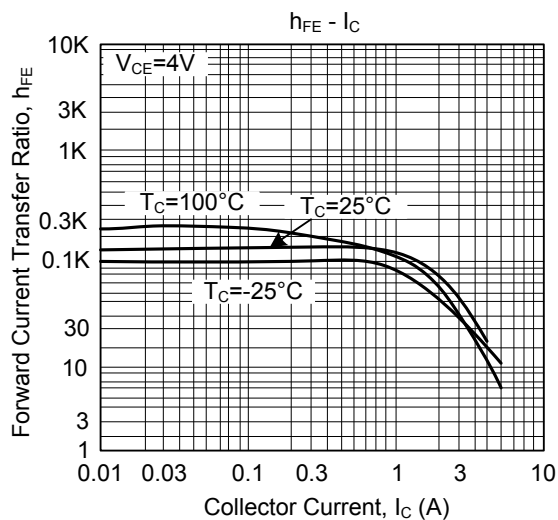
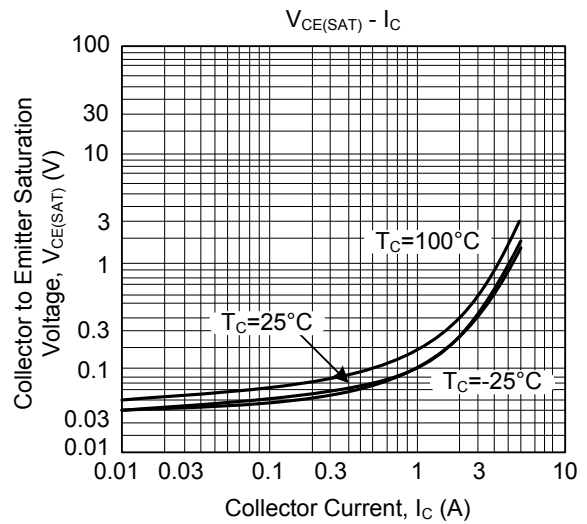
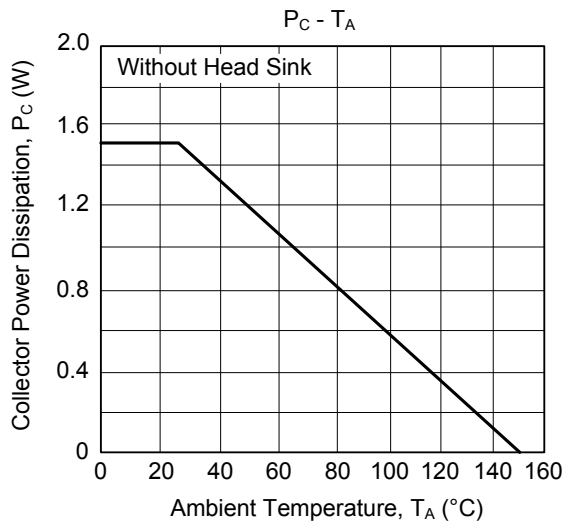
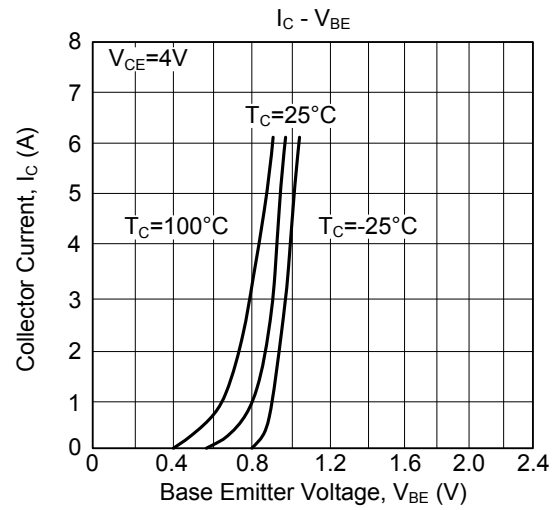
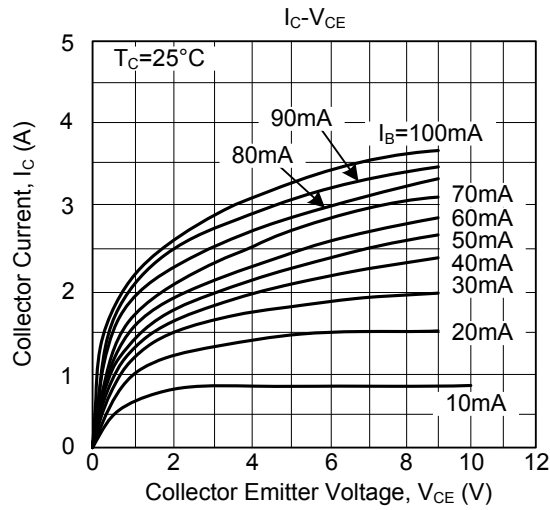

■ TYPICAL CHARACTERISTICS(Cont.)

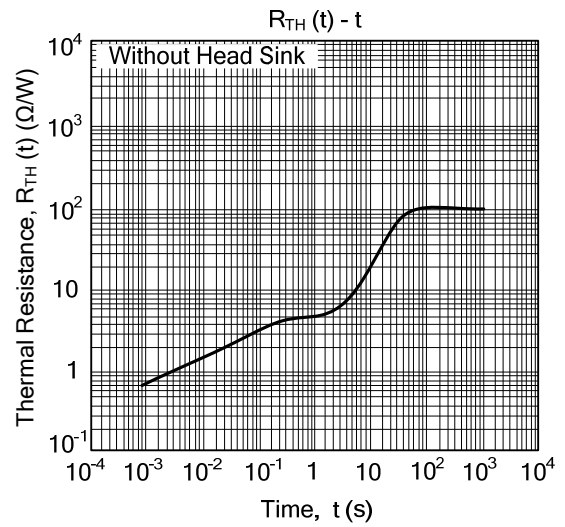
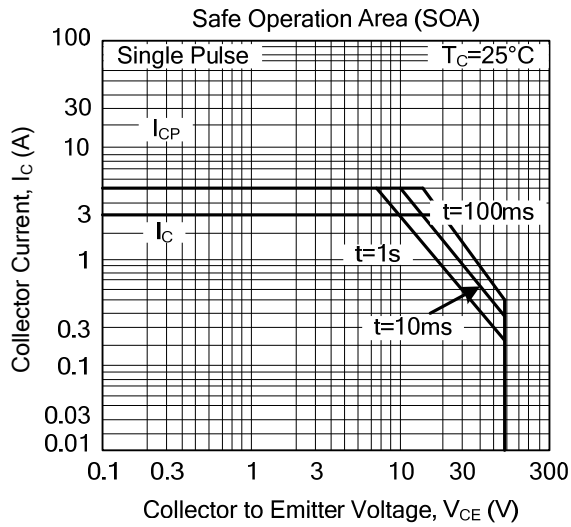

UTC assumes no responsibility for equipment failures that result from using products at values that exceed, even momentarily, rated values (such as maximum ratings, operating condition ranges, or other parameters) listed in products specifications of any and all UTC products described or contained herein. UTC products are not designed for use in life support appliances, devices or systems where malfunction of these products can be reasonably expected to result in personal injury. Reproduction in whole or in part is prohibited without the prior written consent of the copyright owner. The information presented in this document does not form part of any quotation or contract, is believed to be accurate and reliable and may be changed without notice.