



2SD313

NPN SILICON TRANSISTOR

NPN EPITAXIAL PLANAR TRANSISTOR

DESCRIPTION

The UTC **2SD313** is designed for use in general purpose amplifier and switching applications.

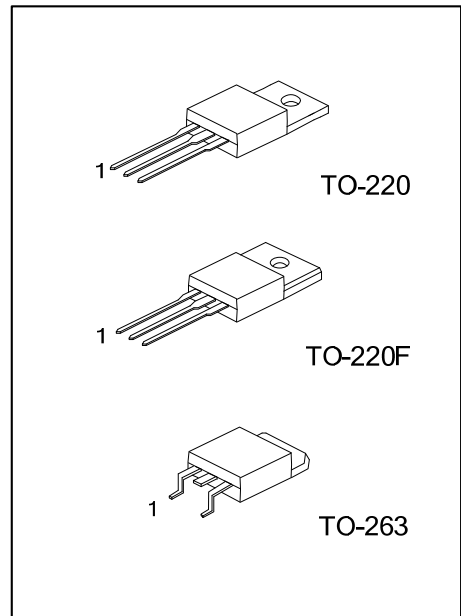

ORDERING INFORMATION

Ordering Number		Package	Pin Assignment			Packing
Lead Free	Halogen Free		1	2	3	
2SD313L-x-TA3-T	2SD313G-x-TA3-T	TO-220	B	C	E	Tube
2SD313L-x-TF3-T	2SD313G-x-TF3-T	TO-220F	B	C	E	Tube
2SD313L-x-TQ2-T	2SD313G-x-TQ2-T	TO-263	B	C	E	Tube
2SD313L-x-TQ2-R	2SD313G-x-TQ2-R	TO-263	B	C	E	Tape Reel

Note: Pin assignment: E: Emitter B: Base C: Collector

<p>2SD313L-x-TA3-T</p>	<p>(1) T: Tube, R: Tape Reel (2) TA3: TO-220, TF3: TO-220F, TQ2: TO-263 (3) x: refer to Classification of h_{FE} (4) L: Lead Free, G: Halogen Free</p>
------------------------	-------------------------------------------------------------------------------------------------------------------------------------------------------------------------------

MARKING

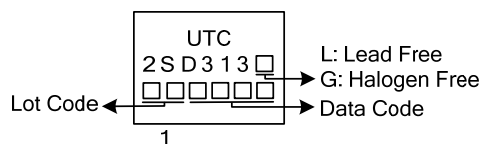

■ ABSOLUTE MAXIMUM RATINGS ($T_A=25^\circ\text{C}$, unless otherwise specified)

PARAMETER		SYMBOL	RATINGS	UNIT
Collector-Base Voltage		V_{CB0}	60	V
Collector-Emitter Voltage		V_{CE0}	60	V
Emitter-Base Voltage		V_{EB0}	5	V
Collector Current		I_C	3	A
Collector Dissipation	TO-220	P_C	1.75	W
	TO-220F		1.6	
	TO-263		1.73	
Junction Temperature		T_J	+150	$^\circ\text{C}$
Storage Temperature		T_{STG}	-55 ~ +150	$^\circ\text{C}$

Note: Absolute maximum ratings are those values beyond which the device could be permanently damaged. Absolute maximum ratings are stress ratings only and functional device operation is not implied.

■ ELECTRICAL CHARACTERISTICS ($T_A=25^\circ\text{C}$, unless otherwise specified)

PARAMETER	SYMBOL	TEST CONDITIONS	MIN	TYP	MAX	UNIT
Collector-Base Breakdown Voltage	BV_{CB0}	$I_C=1\text{mA}$	60			V
Collector-Emitter Breakdown Voltage	BV_{CE0}	$I_C=10\text{mA}$	60			V
Emitter-Base Breakdown Voltage	BV_{EB0}	$I_E=100\mu\text{A}$	5			V
Collector Cut-Off Current	I_{CBO}	$V_{CB}=20\text{V}, I_E=0$			0.1	mA
Emitter Cut-Off Current	I_{EBO}	$V_{EB}=4\text{V}, I_C=0$			1.0	mA
DC Current Gain	h_{FE}	$I_C=1\text{A}, V_{CE}=2\text{V}$	40		320	
		$I_C=0.1\text{A}, V_{CE}=2\text{V}$	40			
Collector-Emitter Saturation Voltage	$V_{CE(SAT)}$	$I_C=2\text{A}, I_B=0.2\text{A}$			1.0	V
Base-Emitter On voltage	$V_{BE(ON)}$	$V_{CE}=2\text{V}, I_C=1\text{A}$			1.5	V
Gain Band width Product	f_T	$V_{CE}=5\text{V}, I_C=0.5\text{A}$		8		MHz

■ CLASSIFICATION ON h_{FE}

RANK	C	D	E	F
RANGE	40-80	60-120	100-200	160-320

TYPICAL CHARACTERISTICS

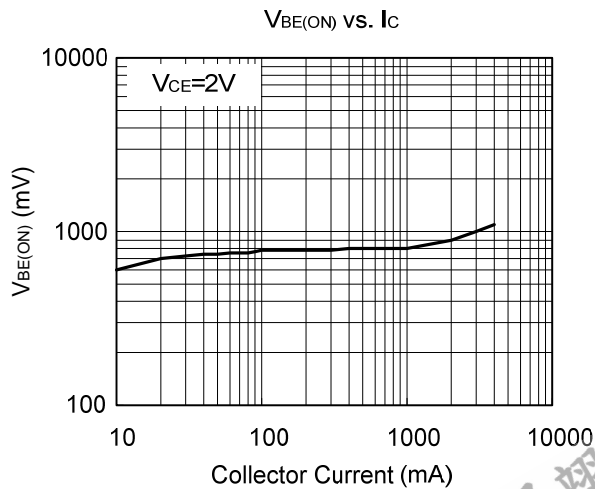
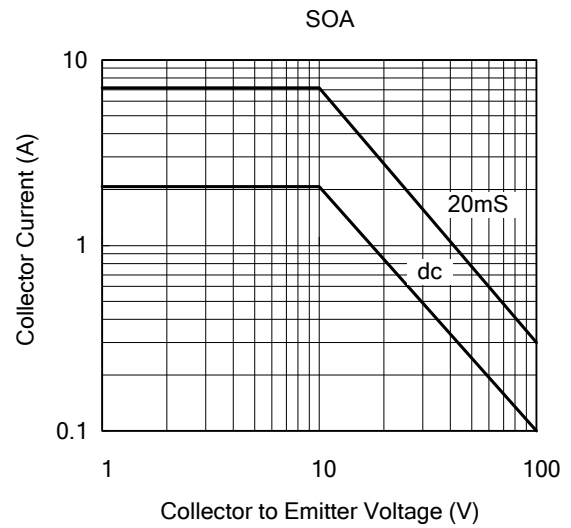
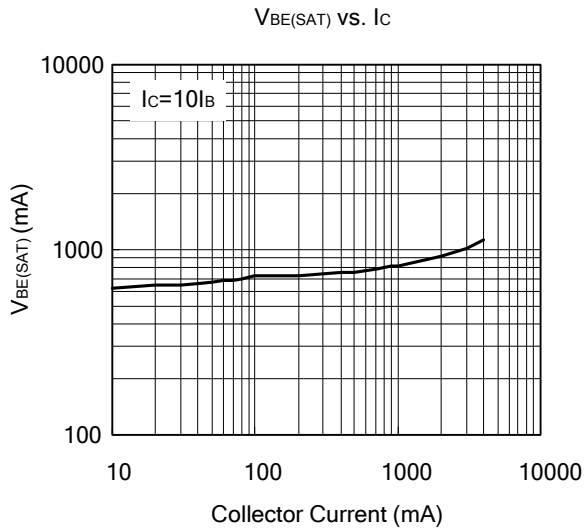
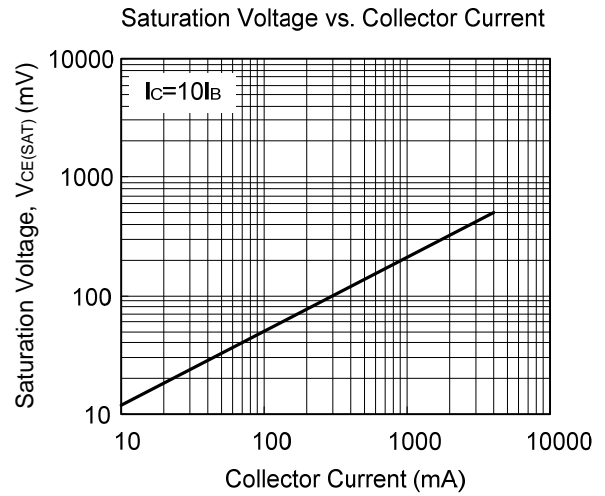
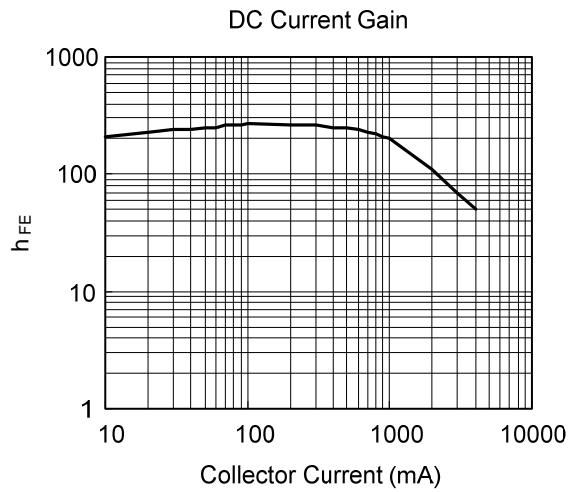

UTC assumes no responsibility for equipment failures that result from using products at values that exceed, even momentarily, rated values (such as maximum ratings, operating condition ranges, or other parameters) listed in products specifications of any and all UTC products described or contained herein. UTC products are not designed for use in life support appliances, devices or systems where malfunction of these products can be reasonably expected to result in personal injury. Reproduction in whole or in part is prohibited without the prior written consent of the copyright owner. The information presented in this document does not form part of any quotation or contract, is believed to be accurate and reliable and may be changed without notice.