



General

- Inrush withstand capability
- Wire-In-Air technology
- Wide range of current rating available
- 6.1mm× 2.5mm square shape surface mount
- Higher temperature profiles
- -55°C~125°C operating temperature
- Excellent environmental integrity
- RoHS compliant
- Halogen-free

Agency / Certificate Information

Agency	File Number	Ampere Range
	E319512	0.5A~5A
	J50260452	0.5A~5A
	SU05049-15003A	0.5A
	SU05049-15001	1A~2.5A
	SU05049-15002	3A~5A

Application

- Battery pack
- Power supply
- PC & PC peripherals
- PC server
- Wireless basestation
- Industrial equipment
- Telecom system
- LCD monitor and modules
- Medical equipment

Electrical Specifications

Part Number	Current Rating (A)	Voltage Rating (V)	Interrupting Rating (V)	Typical Cold DCR* (mΩ)	Typical I ² T** (A ² sec)
S6125-M2-0.5A G	0.5	250	UL/TUV/KC 35A 250V AC 50A 125V DC	260.0	0.285
S6125-M2-1.0A G	1	250	UL/TUV/KC 50A 250V AC 50A 125V DC	119.0	1.54
S6125-M2-1.25A G	1.25	250		84.0	2.42
S6125-M2-1.5A G	1.5	250		76.0	3.03
S6125-M2-1.6A G	1.6	250		70.0	3.99
S6125-M2-2.0A G	2	250		55.0	4.86
S6125-M2-2.5A G	2.5	250		38.0	7.58
S6125-M2-3.0A G	3	250		27.0	10.62
S6125-M2-3.15A G	3.15	250		24.0	12.40
S6125-M2-3.5A G	3.5	250		22.0	16.17
S6125-M2-4.0A G	4	250		20.0	20.00
S6125-M2-5.0A G	5	250		13.0	27.50

* Measured at ≤10% rated current and 25°C

** Melting I²T at 10 times of rated current

Part Number Information

S 6125–M2–1.25A G

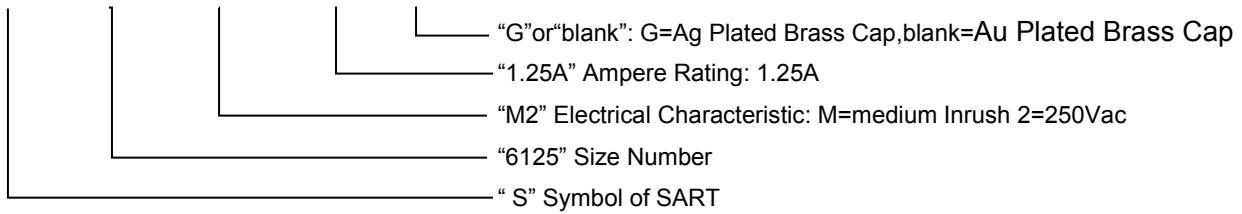

Dimensions

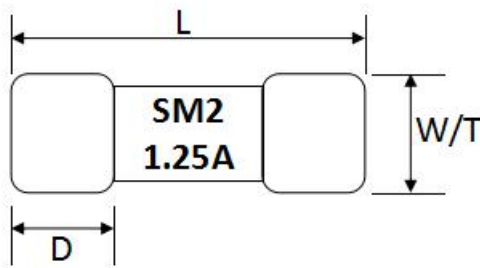

Type	L (mm)	W/ T (mm)	D (mm)
S6125	6.10±0.20	2.50±0.10	1.40±0.10

Recommended Land Patterns

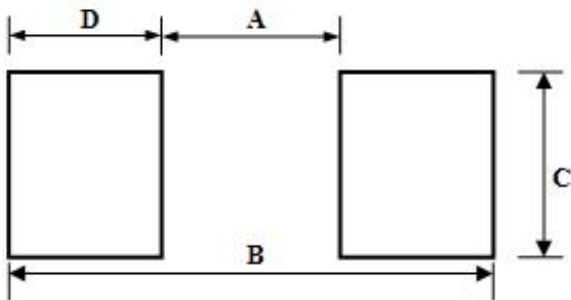

Materials

Components	Material
Body	Ceramic
Terminations	Au Plated Brass Cap or Ag Plated Brass Cap
Element	Nickel alloy or Copper Alloy

Type	A(mm)	B(mm)	C(mm)	D(mm)
S6125	3.00±0.30	8.00±0.30	3.00±0.30	2.50±0.30

Dimensions of Standard Test Board

Type	Ampere Rating	Board Thickness (mm)	Copper Layer Thickness (mm)	Copper Trace Width (mm)
S6125	0.5A~5A	1.6	0.035	5

Time Current Curve

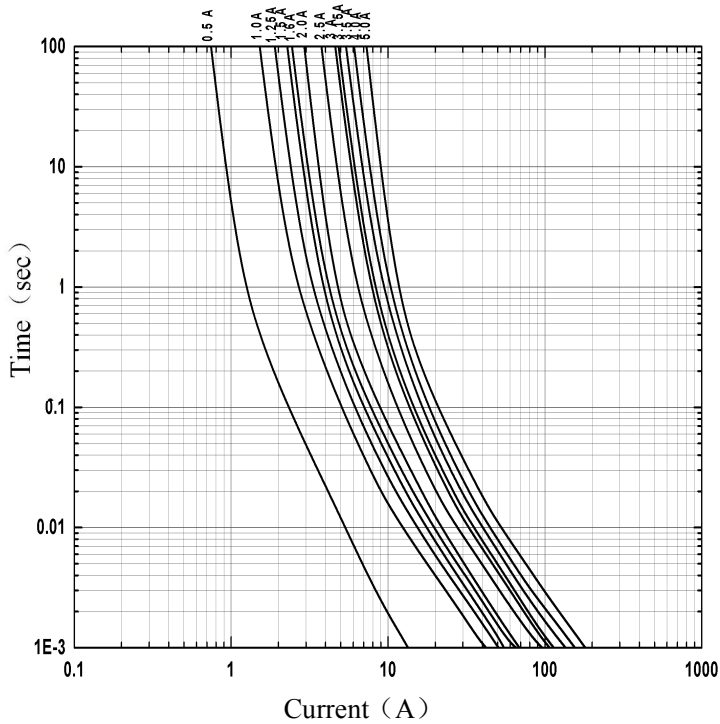

I²T VS Time Curve

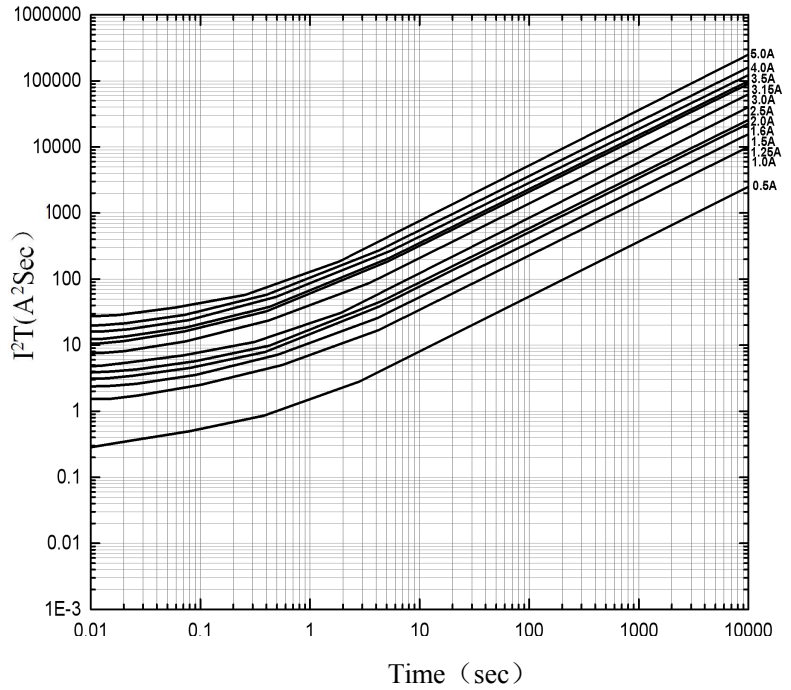

Electrical Characteristics

Type	Ampere Rating	% of Current Rating	Opening Time
S6125	0.5A~5A	100	4hours Min.
	0.5A~5A	200	120sec Max.

Temperature Derating Curve

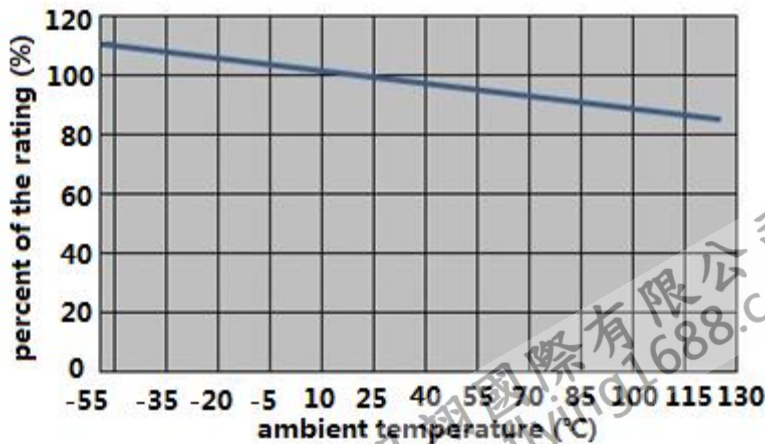

Product Characteristics

Item	Test condition/ Methods	Performance	Standard
Time/Current	100% of current rating	No Fusing, 4hours Min.	UL248-14
	200% of current rating	< 120sec	SART SPEC
	1000% of current rating	> 10msec	IEC60127-4
Voltage Drop	100% of current rating	< 300mV	IEC-60127-4
Endurance Test	Repeating 100 cycles of 100% of current rating for 1hour "ON", for 15min "OFF", then following by 1hour of 125% of current rating and testing Temperature rise	$ \Delta R < 10\%$ $\Delta T < 75^\circ\text{C}$	IEC-60127-4
Interrupting Ability	0.5A: 35A 250V AC 50A 125V DC 1A~5A: 50A 250VAC 50A 125VDC	without permanent arcing, ignition and bursting of fuse link	UL248-14 IEC60127-4
Solder ability	$240^\circ\text{C} \pm 5^\circ\text{C}$, 3sec \pm 0.5sec	95% coverage Min.	IEC60127-4 IEC60068-2-20; MIL-STD-202
Resistance to Soldering	$260^\circ\text{C} \pm 5^\circ\text{C}$, 10sec \pm 0.5sec	$ \Delta R < 10\%$	MIL-STD-202 Method 210
High Temperature Operating Life	$T=70^\circ\text{C} \pm 2^\circ\text{C}$, 60% of current rating, 96 hours	$ \Delta R < 10\%$	MIL-STD-202 Method 108
Humidity (Steady State)	$T=40^\circ\text{C} \pm 2^\circ\text{C}$, RH =90%~95%, 1000 hours	$ \Delta R < 10\%$	MIL-STD-202 Method 103
Low Temperature Storage	$T=-55^\circ\text{C} \pm 3^\circ\text{C}$, 96 hours	$ \Delta R < 10\%$	IEC60068-2-1
High Temperature Storage	$T=125^\circ\text{C} \pm 2^\circ\text{C}$, 96 hours	$ \Delta R < 10\%$	IEC60068-2-2
Salt Spray	5% salt solution, 48 hours	$ \Delta R < 10\%$	MIL-STD-202 Method 101
Thermal Shock	100 cycles, -65°C to $+125^\circ\text{C}$, 30 minutes@each extreme	$ \Delta R < (10\%R + 0.005\Omega)$	IEC 60068-2-14

Recommended Solder Curve

1. Infrared Reflow:

- Temperature: 260°C
- Time: 20sec Max.
- Thickness of solder paste: 0.2mm Max
- Recommend Reflow profile

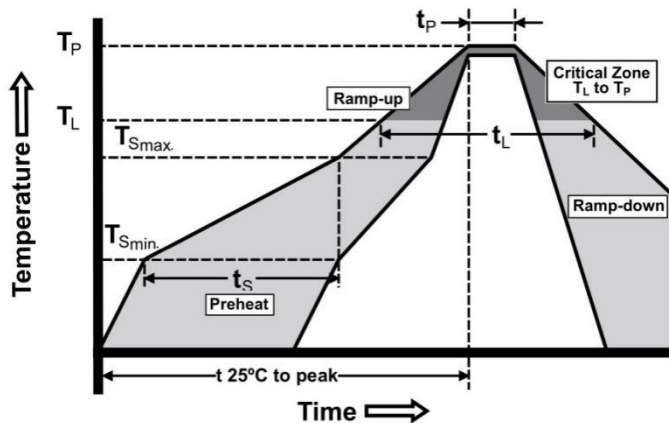

Profile Feature	Pb-Free Assembly
Average Ramp-up Rate(T_{Smax} to T_p)	3°C/sec Max.
Preheat Temperature Min. (T_{Smin}) Temperature Max. (T_{Smax}) Time (T_{Smin} to T_{Smax})	150°C 200°C 60sec~120sec
Peak Temperature (T_p)	260°C
Time within 5°C of actual Peak Temperature (t_p)	20sec
Melting tin time (t_L)	60sec~150sec
Temperature (T_L)	217°C
Ramp-down Rate	6°C/sec Max.
Time 25°C to peak Temperature	8minutes Max.

Packaging

- 1000 pieces of fuses in emboss taper and reeled on a 178mm(7 inch) reel.

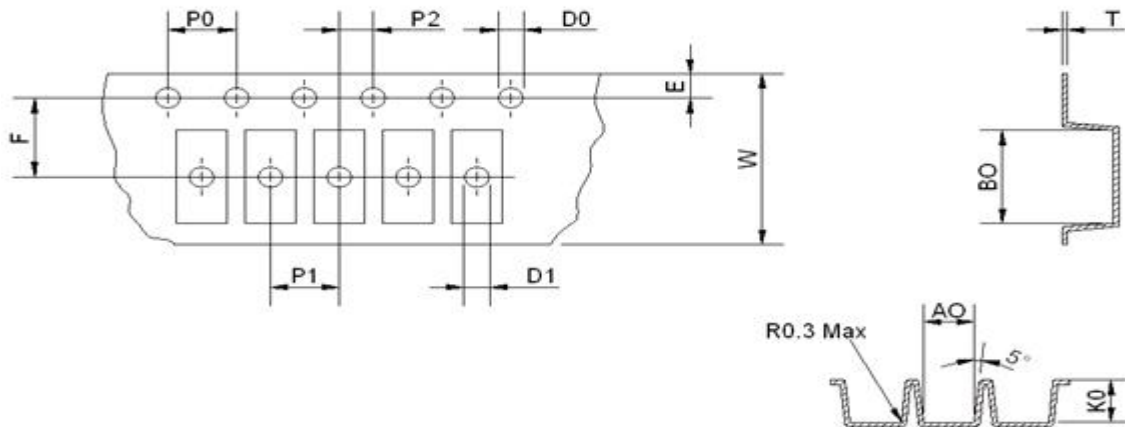

Type	A0(mm)	B0(mm)	K0(mm)	P0(mm)	P1(mm)	P2(mm)
S6125	2.70±0.10	6.40±0.10	2.70±0.10	4.00±0.10	4.00±0.10	2.00±0.10
Type	E(mm)	F(mm)	D0(mm)	D1(mm)	W(mm)	T(mm)
S6125	1.75±0.10	5.50±0.10	1.50±0.10	1.50±0.25	12.00±0.15	0.25±0.05

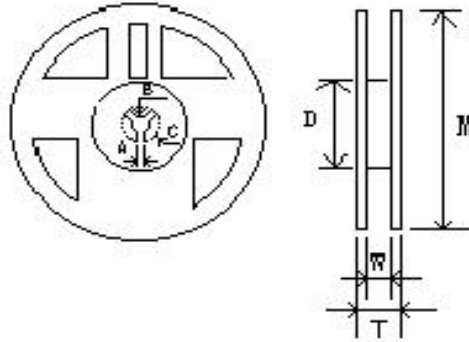

Type	M(mm)	W(mm)	T(mm)	A(mm)	B(mm)	C(mm)	D(mm)
S6125	178.00±2.00	12.50±1.00	14.50±1.50	2.00±0.50	13.00±0.50	21.00±0.50	58.00±2.00

Storage

- The ambient temperature recommended for storage shall be between 5°C~30°C.
- The relative humidity recommended for storage shall be between 25%RH~60%RH.
- Sealed plastic bags with desiccant shall be used to reduce the oxidation of the termination and shall only be opened prior to use.
- The products shall not be stored in areas where harmful gases containing sulfur or chlorine are present.