



# 78LXX

## LINEAR INTEGRATED CIRCUIT

### 3-TERMINAL 0.1A POSITIVE VOLTAGE REGULATOR

■ DESCRIPTION

The UTC **78LXX** family is monolithic fixed voltage regulator integrated circuit. They are suitable for applications that required supply current up to 100mA.

■ FEATURES

- \* Output current up to 100mA
- \* Fixed output voltage of 5V, 6V, 8V, 9V, 10V, 12V, 15V and 18V available
- \* Thermal overload shutdown protection
- \* Short circuit current limiting

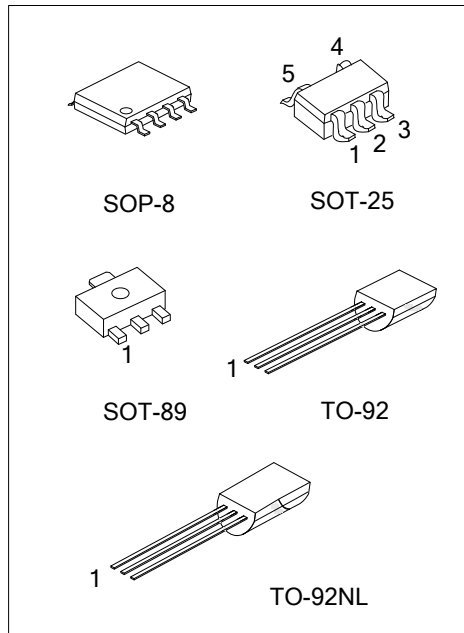

■ ORDERING INFORMATION

| Ordering Number |                | Package | Pin Assignment |   |   |   |   |   |   |   | Packing   |
|-----------------|----------------|---------|----------------|---|---|---|---|---|---|---|-----------|
| Lead Free       | Halogen Free   |         | 1              | 2 | 3 | 4 | 5 | 6 | 7 | 8 |           |
| 78LXXL-AB3-R    | 78LXXG-AB3-R   | SOT-89  | O              | G | I | - | - | - | - | - | Tape Reel |
| 78LXXL-AB3-C-R  | 78LXXG-AB3-C-R | SOT-89  | G              | I | O | - | - | - | - | - | Tape Reel |
| 78LXXL-AF5-R    | 78LXXG-AF5-R   | SOT-25  | G              | I | O | N | N |   |   |   | Tape Reel |
| 78LXXL-S08-R    | 78LXXG-S08-R   | SOP-8   | O              | G | G | N | N | G | G | I | Tape Reel |
| 78LXXL-T92-B    | 78LXXG-T92-B   | TO-92   | O              | G | I | - | - | - | - | - | Tape Box  |
| 78LXXL-T92-K    | 78LXXG-T92-K   | TO-92   | O              | G | I | - | - | - | - | - | Bulk      |
| 78LXXL-T9N-B    | 78LXXG-T9N-B   | TO-92NL | O              | G | I | - | - | - | - | - | Tape Box  |
| 78LXXL-T9N-K    | 78LXXG-T9N-K   | TO-92NL | O              | G | I | - | - | - | - | - | Bulk      |

Note: 1. XX: Output Voltage, refer to Marking Information.  
 2. Pin Assignment: O: Output G: GND I: Input N: No Connection

|                       |   |
|-----------------------|---|
| <p>78LXXG-AB3-C-R</p> | <p>(1) B: Tape Box, K: Bulk, R: Tape Reel<br/>                 (2) refer to Pin Assignment<br/>                 (3) AB3: SOT-89, AF5: SOT-25, S08: SOP-8, T92: TO-92, T9N: TO-92NL<br/>                 (4) G: Halogen Free and Lead Free, L: Lead Free<br/>                 (5) XX: refer to Marking Information</p> |
|-----------------------|---|



### MARKING INFORMATION

| PACKAGE | VOLTAGE CODE                           | MARKING |
|---------|--|---------|
| SOT-89  |  |         |
| SOT-25  | 05:5.0V<br>06:6.0V                     |         |
| SOP-8   | 08:8.0V<br>09:9.0V<br>10:10V<br>12:12V |         |
| TO-92   | 15:15V<br>18:18V                       |         |
| TO-92NL |  |         |

FLYING 飛翔國際有限公司

### ■ ABSOLUTE MAXIMUM RATINGS

| PARAMETER                      |                      | SYMBOL    | RATINGS    | UNIT |
|--------------------------------|----------------------|-----------|------------|------|
| Input Voltage                  | $V_{OUT}=5\sim 9V$   | $V_{IN}$  | 30         | V    |
|                                | $V_{OUT}=10\sim 18V$ |           | 35         |      |
| Output Current                 |                      | $I_{OUT}$ | 100        | mA   |
| Power Dissipation              | SOT-89               | $P_D$     | 350        | mW   |
|                                | SOT-25               |           | 240        | mW   |
|                                | SOP-8                |           | 300        | mW   |
|                                | TO-92/TO-92NL        |           | 625        | mW   |
| Junction Temperature           |                      | $T_J$     | +150       | °C   |
| Operating Temperature (Note 2) |                      | $T_{OPR}$ | -40 ~ +125 | °C   |
| Storage Temperature            |                      | $T_{STG}$ | -55 ~ +150 | °C   |

- Notes: 1. Absolute maximum ratings are those values beyond which the device could be permanently damaged. Absolute maximum ratings are stress ratings only and functional device operation is not implied.  
2. It is guarantee by design, not 100% be tested.

### ■ ELECTRICAL CHARACTERISTICS

For UTC78L05 ( $V_{IN}=10V$ ,  $I_{OUT}=40mA$ ,  $0^\circ C < T_J < 150^\circ C$ ,  $C_1=0.33\mu F$ ,  $C_o=0.1\mu F$ , unless otherwise specified)

| PARAMETER                            | SYMBOL                | TEST CONDITIONS                                    | MIN  | TYP | MAX  | UNIT       |
|--------------------------------------|-----------------------|--|------|-----|------|------------|
| Output Voltage                       | $V_{OUT}$             | $T_J=25^\circ C$                                   | 4.80 | 5.0 | 5.20 | V          |
|                                      |                       | $7V \leq V_{IN} \leq 20V, I_{OUT}=1mA-40mA$        | 4.75 |     | 5.25 | V          |
|                                      |                       | $7V \leq V_{IN} \leq V_{MAX}, I_{OUT}=1mA-70mA$    | 4.75 |     | 5.25 | V (note 2) |
| Load Regulation                      | $\Delta V_{OUT}$      | $T_J=25^\circ C, I_{OUT}=1mA-100mA$                |      | 15  | 60   | mV         |
|                                      |                       | $T_J=25^\circ C, I_{OUT}=1mA-40mA$                 |      | 8   | 30   | mV         |
| Line regulation                      | $\Delta V_{OUT}$      | $7V \leq V_{IN} \leq 20V, T_J=25^\circ C$          |      | 8   | 150  | mV         |
|                                      |                       | $8V \leq V_{IN} \leq 20V, T_J=25^\circ C$          |      | 6   | 100  | mV         |
| Quiescent Current                    | $I_Q$                 | $V_{IN}=10V, I_{OUT}=0mA, T_J=25^\circ C$          |      | 2.0 | 5.5  | mA         |
| Quiescent Current Change             | $\Delta I_Q$          | $8V \leq V_{IN} \leq 20V$                          |      |     | 1.5  | mA         |
|                                      |                       | $1mA \leq V_{IN} \leq 40mA$                        |      |     | 0.1  | mA         |
| Output Noise Voltage                 | eN                    | $10Hz \leq f \leq 100kHz$                          |      | 40  |      | $\mu V$    |
| Temperature coefficient of $V_{OUT}$ | $\Delta V_O/\Delta T$ | $I_{OUT}=5mA$                                      |      | 1.0 |      | mV/°C      |
| Ripple Rejection                     | RR                    | $8V \leq V_{IN} \leq 20V, f=120Hz, T_J=25^\circ C$ |      | 60  |      | dB         |
| Dropout Voltage                      | $V_D$                 | $T_J=25^\circ C$                                   |      | 1.7 |      | V          |

For UTC78L06 ( $V_{IN}=12V$ ,  $I_{OUT}=40mA$ ,  $0^\circ C < T_J < 150^\circ C$ ,  $C_1=0.33\mu F$ ,  $C_o=0.1\mu F$ , unless otherwise specified)

| PARAMETER                            | SYMBOL                | TEST CONDITIONS                                     | MIN  | TYP | MAX  | UNIT       |
|--------------------------------------|-----------------------|---|------|-----|------|------------|
| Output Voltage                       | $V_{OUT}$             | $T_J=25^\circ C$                                    | 5.76 | 6.0 | 6.24 | V          |
|                                      |                       | $8.5V \leq V_{IN} \leq 20V, I_{OUT}=1mA-40mA$       | 5.70 |     | 6.30 | V          |
|                                      |                       | $8.5V \leq V_{IN} \leq V_{MAX}, I_{OUT}=1mA-70mA$   | 5.70 |     | 6.30 | V (note 2) |
| Load Regulation                      | $\Delta V_{OUT}$      | $T_J=25^\circ C, I_{OUT}=1mA-100mA$                 |      | 16  | 80   | mV         |
|                                      |                       | $T_J=25^\circ C, I_{OUT}=1mA-40mA$                  |      | 9   | 40   | mV         |
| Line regulation                      | $\Delta V_{OUT}$      | $8.5V \leq V_{IN} \leq 20V, T_J=25^\circ C$         |      | 10  | 175  | mV         |
|                                      |                       | $9V \leq V_{IN} \leq 20V, T_J=25^\circ C$           |      | 8   | 125  | mV         |
| Quiescent Current                    | $I_Q$                 | $V_{IN}=12V, I_{OUT}=0mA, T_J=25^\circ C$           |      | 2.0 | 5.5  | mA         |
| Quiescent Current Change             | $\Delta I_Q$          | $9V \leq V_{IN} \leq 20V$                           |      |     | 1.5  | mA         |
|                                      |                       | $1mA \leq V_{IN} \leq 40mA$                         |      |     | 0.1  | mA         |
| Output Noise Voltage                 | eN                    | $10Hz \leq f \leq 100kHz$                           |      | 49  |      | $\mu V$    |
| Temperature coefficient of $V_{OUT}$ | $\Delta V_O/\Delta T$ | $I_{OUT}=5mA$                                       |      | 1.3 |      | mV/°C      |
| Ripple Rejection                     | RR                    | $10V \leq V_{IN} \leq 20V, f=120Hz, T_J=25^\circ C$ |      | 56  |      | dB         |
| Dropout Voltage                      | $V_D$                 | $T_J=25^\circ C$                                    |      | 1.7 |      | V          |

■ ELECTRICAL CHARACTERISTICS (Cont.)

For UTC78L08 ( $V_{IN}=14V$ ,  $I_{OUT}=40mA$ ,  $0^{\circ}C < T_J < 150^{\circ}C$ ,  $C_1=0.33\mu F$ ,  $C_o=0.1\mu F$ , unless otherwise specified)

| PARAMETER                        | SYMBOL                | TEST CONDITIONS                                      | MIN  | TYP | MAX  | UNIT           |
|----------------------------------|-----------------------|--|------|-----|------|----------------|
| Output Voltage                   | $V_{OUT}$             | $T_J=25^{\circ}C$                                    | 7.68 | 8.0 | 8.32 | V              |
|                                  |                       | $10.5V \leq V_{IN} \leq 23V, I_{OUT}=1mA-40mA$       | 7.60 |     | 8.40 | V              |
|                                  |                       | $10.5V \leq V_{IN} \leq V_{MAX}, I_{OUT}=1mA-70mA$   | 7.60 |     | 8.40 | V(note 2)      |
| Load Regulation                  | $\Delta V_{OUT}$      | $T_J=25^{\circ}C, I_{OUT}=1mA-100mA$                 |      | 18  | 80   | mV             |
|                                  |                       | $T_J=25^{\circ}C, I_{OUT}=1mA-40mA$                  |      | 10  | 40   | mV             |
| Line regulation                  | $\Delta V_{OUT}$      | $10.5V \leq V_{IN} \leq 23V, T_J=25^{\circ}C$        |      | 12  | 175  | mV             |
|                                  |                       | $11V \leq V_{IN} \leq 23V, T_J=25^{\circ}C$          |      | 10  | 125  | mV             |
| Quiescent Current                | $I_Q$                 | $V_{IN}=14V, I_{OUT}=0mA, T_J=25^{\circ}C$           |      | 2.0 | 5.5  | mA             |
| Quiescent Current Change         | $\Delta I_Q$          | $11V \leq V_{IN} \leq 23V$                           |      |     | 1.5  | mA             |
|                                  |                       | $1mA \leq V_{IN} \leq 40mA$                          |      |     | 0.1  | mA             |
| Output Noise Voltage             | eN                    | $10Hz \leq f \leq 100kHz$                            |      | 49  |      | $\mu V$        |
| Temperature coefficient of $V_o$ | $\Delta V_o/\Delta T$ | $I_{OUT}=5mA$  |      | 1.5 |      | $mV/^{\circ}C$ |
| Ripple Rejection                 | RR                    | $11V \leq V_{IN} \leq 23V, f=120Hz, T_J=25^{\circ}C$ |      | 52  |      | dB             |
| Dropout Voltage                  | $V_D$                 | $T_J=25^{\circ}C$                                    |      | 1.7 |      | V              |

For UTC78L09 ( $V_{IN}=15V$ ,  $I_{OUT}=40mA$ ,  $0^{\circ}C < T_J < 150^{\circ}C$ ,  $C_1=0.33\mu F$ ,  $C_o=0.1\mu F$ , unless otherwise specified)

| PARAMETER                            | SYMBOL                | TEST CONDITIONS                                      | MIN  | TYP | MAX  | UNIT           |
|--------------------------------------|-----------------------|--|------|-----|------|----------------|
| Output Voltage                       | $V_{OUT}$             | $T_J=25^{\circ}C$                                    | 8.64 | 9.0 | 9.36 | V              |
|                                      |                       | $11.5V \leq V_{IN} \leq 24V, I_{OUT}=1mA-40mA$       | 8.55 |     | 9.45 | V              |
|                                      |                       | $11.5V \leq V_{IN} \leq V_{MAX}, I_{OUT}=1mA-70mA$   | 8.55 |     | 9.45 | V(note 2)      |
| Load Regulation                      | $\Delta V_{OUT}$      | $T_J=25^{\circ}C, I_{OUT}=1mA-100mA$                 |      | 20  | 90   | mV             |
|                                      |                       | $T_J=25^{\circ}C, I_{OUT}=1mA-40mA$                  |      | 10  | 40   | mV             |
| Line regulation                      | $\Delta V_{OUT}$      | $11.5V \leq V_{IN} \leq 24V, T_J=25^{\circ}C$        |      | 15  | 200  | mV             |
|                                      |                       | $13V \leq V_{IN} \leq 24V, T_J=25^{\circ}C$          |      | 10  | 150  | mV             |
| Quiescent Current                    | $I_Q$                 | $V_{IN}=15V, I_{OUT}=0mA, T_J=25^{\circ}C$           |      | 2.0 | 6.0  | mA             |
| Quiescent Current Change             | $\Delta I_Q$          | $13V \leq V_{IN} \leq 24V$                           |      |     | 1.5  | mA             |
|                                      |                       | $1mA \leq V_{IN} \leq 40mA$                          |      |     | 0.1  | mA             |
| Output Noise Voltage                 | eN                    | $10Hz \leq f \leq 100kHz$                            |      | 70  |      | $\mu V$        |
| Temperature coefficient of $V_{OUT}$ | $\Delta V_o/\Delta T$ | $I_{OUT}=5mA$  |      | 1.6 |      | $mV/^{\circ}C$ |
| Ripple Rejection                     | RR                    | $12V \leq V_{IN} \leq 24V, f=120Hz, T_J=25^{\circ}C$ |      | 46  |      | dB             |
| Dropout Voltage                      | $V_D$                 | $T_J=25^{\circ}C$                                    |      | 1.7 |      | V              |

For UTC78L10 ( $V_{IN}=16V$ ,  $I_{OUT}=40mA$ ,  $0^{\circ}C < T_J < 150^{\circ}C$ ,  $C_1=0.33\mu F$ ,  $C_o=0.1\mu F$ , unless otherwise specified)

| PARAMETER                            | SYMBOL                | TEST CONDITIONS                                      | MIN | TYP  | MAX  | UNIT           |
|--------------------------------------|-----------------------|--|-----|------|------|----------------|
| Output Voltage                       | $V_{OUT}$             | $T_J=25^{\circ}C$                                    | 9.6 | 10.0 | 10.4 | V              |
|                                      |                       | $12.5V \leq V_{IN} \leq 25V, I_{OUT}=1mA-40mA$       | 9.5 |      | 10.5 | V              |
|                                      |                       | $12.5V \leq V_{IN} \leq V_{MAX}, I_{OUT}=1mA-70mA$   | 9.5 |      | 10.5 | V(note 2)      |
| Load Regulation                      | $\Delta V_{OUT}$      | $T_J=25^{\circ}C, I_{OUT}=1mA-100mA$                 |     | 20   | 90   | mV             |
|                                      |                       | $T_J=25^{\circ}C, I_{OUT}=1mA-40mA$                  |     | 10   | 45   | mV             |
| Line regulation                      | $\Delta V_{OUT}$      | $12.5V \leq V_{IN} \leq 25V, T_J=25^{\circ}C$        |     | 25   | 200  | mV             |
|                                      |                       | $14V \leq V_{IN} \leq 25V, T_J=25^{\circ}C$          |     | 20   | 170  | mV             |
| Quiescent Current                    | $I_Q$                 | $V_{IN}=17V, I_{OUT}=0mA, T_J=25^{\circ}C$           |     | 2.0  | 6.0  | mA             |
| Quiescent Current Change             | $\Delta I_Q$          | $12.5V \leq V_{IN} \leq 25V$                         |     |      | 1.5  | mA             |
|                                      |                       | $1mA \leq V_{IN} \leq 40mA$                          |     |      | 0.1  | mA             |
| Output Noise Voltage                 | eN                    | $10Hz \leq f \leq 100kHz$                            |     | 74   |      | $\mu V$        |
| Temperature coefficient of $V_{OUT}$ | $\Delta V_o/\Delta T$ | $I_{OUT}=5mA$  |     | 1.7  |      | $mV/^{\circ}C$ |
| Ripple Rejection                     | RR                    | $15V \leq V_{IN} \leq 25V, f=120Hz, T_J=25^{\circ}C$ |     | 45   |      | dB             |
| Dropout Voltage                      | $V_D$                 | $T_J=25^{\circ}C$                                    |     | 1.7  |      | V              |

■ ELECTRICAL CHARACTERISTICS (Cont.)

For UTC78L12 ( $V_{IN}=19V$ ,  $I_{OUT}=40mA$ ,  $0^{\circ}C < T_J < 150^{\circ}C$ ,  $C_1=0.33\mu F$ ,  $C_o=0.1\mu F$ , unless otherwise specified)

| PARAMETER                            | SYMBOL                | TEST CONDITIONS                                      | MIN   | TYP  | MAX   | UNIT           |
|--------------------------------------|-----------------------|--|-------|------|-------|----------------|
| Output Voltage                       | $V_{OUT}$             | $T_J=25^{\circ}C$                                    | 11.52 | 12.0 | 12.48 | V              |
|                                      |                       | $14.5V \leq V_{IN} \leq 27V, I_{OUT}=1mA-40mA$       | 11.40 |      | 12.60 | V              |
|                                      |                       | $14.5V \leq V_{IN} \leq V_{MAX}, I_{OUT}=1mA-70mA$   | 11.40 |      | 12.60 | V(note 2)      |
| Load Regulation                      | $\Delta V_{OUT}$      | $T_J=25^{\circ}C, I_{OUT}=1mA-100mA$                 |       | 25   | 100   | mV             |
|                                      |                       | $T_J=25^{\circ}C, I_{OUT}=1mA-40mA$                  |       | 12   | 50    | mV             |
| Line regulation                      | $\Delta V_{OUT}$      | $14.5V \leq V_{IN} \leq 27V, T_J=25^{\circ}C$        |       | 25   | 300   | mV             |
|                                      |                       | $16V \leq V_{IN} \leq 27V, T_J=25^{\circ}C$          |       | 20   | 250   | mV             |
| Quiescent Current                    | $I_Q$                 | $V_{IN}=19V, I_{OUT}=0mA, T_J=25^{\circ}C$           |       | 2.0  | 6.5   | mA             |
| Quiescent Current Change             | $\Delta I_Q$          | $16V \leq V_{IN} \leq 27V$                           |       |      | 1.5   | mA             |
|                                      |                       | $1mA \leq V_{IN} \leq 40mA$                          |       |      | 0.1   | mA             |
| Output Noise Voltage                 | eN                    | $10Hz \leq f \leq 100kHz$                            |       | 80   |       | $\mu V$        |
| Temperature coefficient of $V_{OUT}$ | $\Delta V_O/\Delta T$ | $I_{OUT}=5mA$  |       | 1.8  |       | $mV/^{\circ}C$ |
| Ripple Rejection                     | RR                    | $15V \leq V_{IN} \leq 25V, f=120Hz, T_J=25^{\circ}C$ |       | 45   |       | dB             |
| Dropout Voltage                      | $V_D$                 | $T_J=25^{\circ}C$                                    |       | 1.7  |       | V              |

For UTC78L15 ( $V_{IN}=23V$ ,  $I_{OUT}=40mA$ ,  $0^{\circ}C < T_J < 150^{\circ}C$ ,  $C_1=0.33\mu F$ ,  $C_o=0.1\mu F$ , unless otherwise specified)

| PARAMETER                            | SYMBOL                | TEST CONDITIONS  | MIN   | TYP  | MAX   | UNIT           |
|--------------------------------------|-----------------------|--|-------|------|-------|----------------|
| Output Voltage                       | $V_{OUT}$             | $T_J=25^{\circ}C$  | 14.40 | 15.0 | 15.60 | V              |
|                                      |                       | $17.5V \leq V_{IN} \leq 30V, I_{OUT}=1mA-40mA$           | 14.25 |      | 15.75 | V              |
|                                      |                       | $17.5V \leq V_{IN} \leq V_{MAX}, I_{OUT}=1mA-70mA$       | 14.25 |      | 15.75 | V(note 2)      |
| Load Regulation                      | $\Delta V_{OUT}$      | $T_J=25^{\circ}C, I_{OUT}=1mA-100mA$                     |       | 25   | 150   | mV             |
|                                      |                       | $T_J=25^{\circ}C, I_{OUT}=1mA-40mA$                      |       | 15   | 75    | mV             |
| Line Regulation                      | $\Delta V_{OUT}$      | $17.5V \leq V_{IN} \leq 30V, T_J=25^{\circ}C$            |       | 25   | 150   | mV             |
|                                      |                       | $20V \leq V_{IN} \leq 30V, T_J=25^{\circ}C$              |       | 15   | 75    | mV             |
| Quiescent Current                    | $I_Q$                 | $V_{IN}=23V, I_{OUT}=0mA, T_J=25^{\circ}C$               |       | 2.2  | 6.5   | mA             |
| Quiescent Current Change             | $\Delta I_Q$          | $20V \leq V_{IN} \leq 30V$                               |       |      | 1.5   | mA             |
|                                      |                       | $1mA \leq V_{IN} \leq 40mA$                              |       |      | 0.1   | mA             |
| Output Noise Voltage                 | eN                    | $10Hz \leq f \leq 100kHz$                                |       | 90   |       | $\mu V$        |
| Temperature Coefficient of $V_{OUT}$ | $\Delta V_O/\Delta T$ | $I_{OUT}=5mA$  |       | 2.0  |       | $mV/^{\circ}C$ |
| Ripple Rejection                     | RR                    | $18.5V \leq V_{IN} \leq 28.5V, f=120Hz, T_J=25^{\circ}C$ |       | 45   |       | dB             |
| Dropout Voltage                      | $V_D$                 | $T_J=25^{\circ}C$  |       | 1.7  |       | V              |

For UTC78L18 ( $V_{IN}=27V$ ,  $I_{OUT}=40mA$ ,  $0^{\circ}C < T_J < 150^{\circ}C$ ,  $C_1=0.33\mu F$ ,  $C_o=0.1\mu F$ , unless otherwise specified)

| PARAMETER                            | SYMBOL                | TEST CONDITIONS                                      | MIN   | TYP  | MAX   | UNIT           |
|--------------------------------------|-----------------------|--|-------|------|-------|----------------|
| Output Voltage                       | $V_{OUT}$             | $T_J=25^{\circ}C$                                    | 17.28 | 18.0 | 18.72 | V              |
|                                      |                       | $21V \leq V_{IN} \leq 33V, I_{OUT}=1mA-40mA$         | 17.10 |      | 18.90 | V              |
|                                      |                       | $21V \leq V_{IN} \leq V_{MAX}, I_{OUT}=1mA-70mA$     | 17.46 |      | 18.54 | V(note 2)      |
| Load Regulation                      | $\Delta V_{OUT}$      | $T_J=25^{\circ}C, I_{OUT}=1mA-100mA$                 |       | 30   | 180   | mV             |
|                                      |                       | $T_J=25^{\circ}C, I_{OUT}=1mA-40mA$                  |       | 20   | 90    | mV             |
| Line Regulation                      | $\Delta V_{OUT}$      | $21V \leq V_{IN} \leq 33V, T_J=25^{\circ}C$          |       | 45   | 300   | mV             |
|                                      |                       | $22V \leq V_{IN} \leq 33V, T_J=25^{\circ}C$          |       | 35   | 250   | mV             |
| Quiescent Current                    | $I_Q$                 | $V_{IN}=27V, I_{OUT}=0mA, T_J=25^{\circ}C$           |       | 2.2  | 6.5   | mA             |
| Quiescent Current Change             | $\Delta I_Q$          | $21V \leq V_{IN} \leq 33V$                           |       |      | 1.5   | mA             |
|                                      |                       | $1mA \leq V_{IN} \leq 40mA$                          |       |      | 0.1   | mA             |
| Output Noise Voltage                 | eN                    | $10Hz \leq f \leq 100kHz$                            |       | 150  |       | $\mu V$        |
| Temperature Coefficient of $V_{OUT}$ | $\Delta V_O/\Delta T$ | $I_{OUT}=5mA$  |       | 2.2  |       | $mV/^{\circ}C$ |
| Ripple Rejection                     | RR                    | $23V \leq V_{IN} \leq 33V, f=120Hz, T_J=25^{\circ}C$ |       | 45   |       | dB             |
| Dropout Voltage                      | $V_D$                 | $T_J=25^{\circ}C$                                    |       | 1.7  |       | V              |

Note 1. The Maximum steady state usable output current is dependent on input voltage, heat sinking, lead length of the package and copper pattern of PCB.

2. Power dissipation  $< 0.5W$

## APPLICATION CIRCUIT

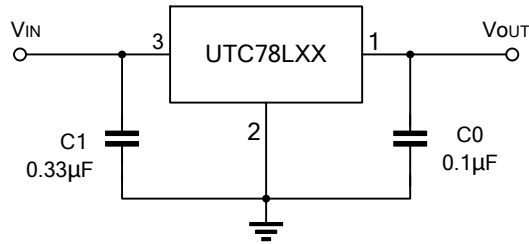

- Notes:
1. To specify an output voltage, substitute voltage value for "XX".
  2. Bypass capacitors are recommended for optimum stability and transient response and should be located as close as possible to the regulators.

## TEST CIRCUIT

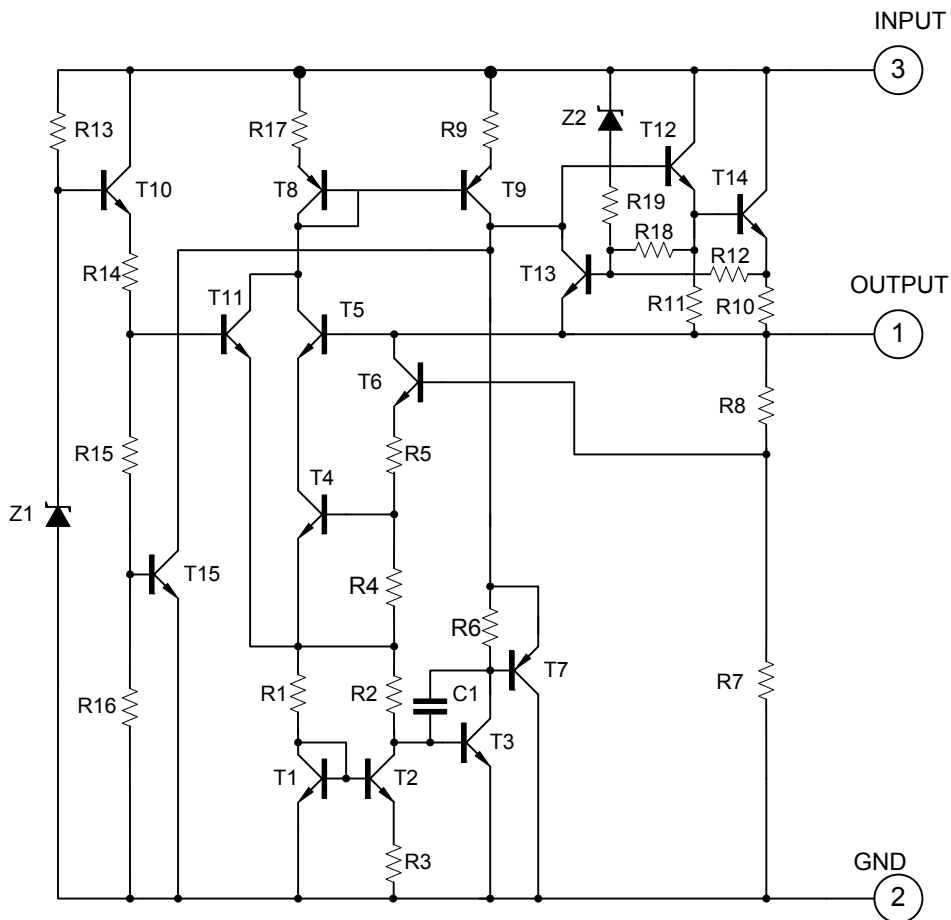

FLYING 飛翔國際有限公司

## ■ TYPICAL CHARACTERISTICS

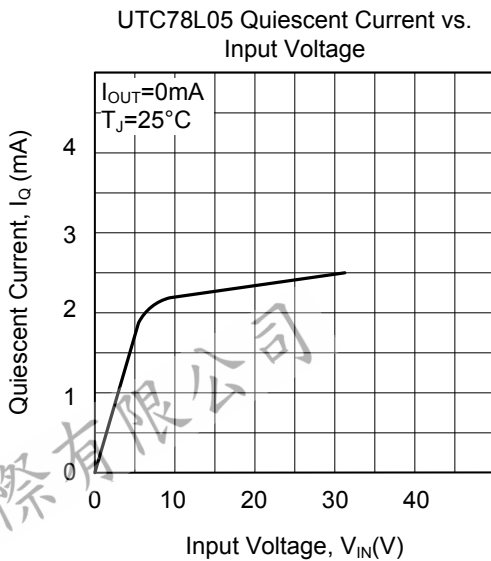
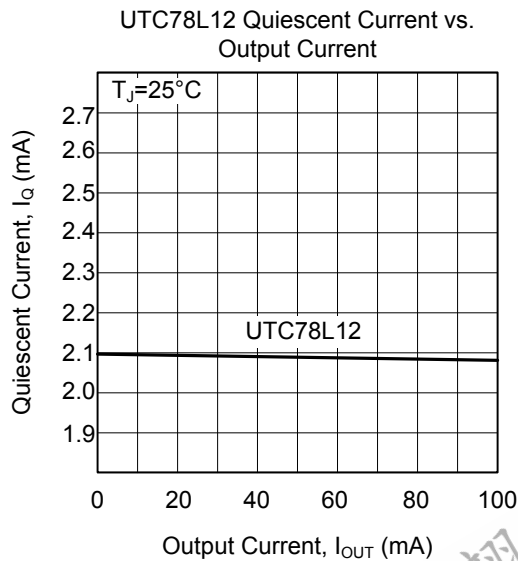
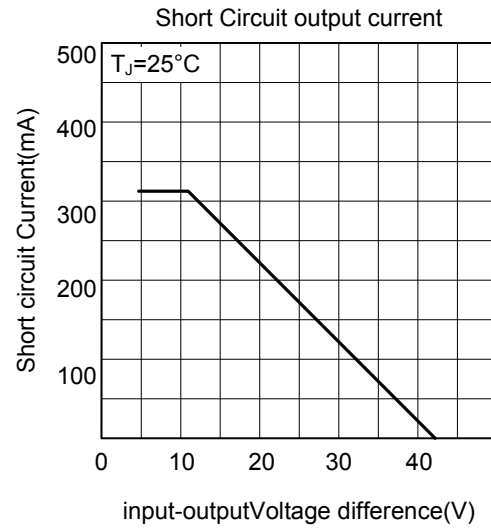
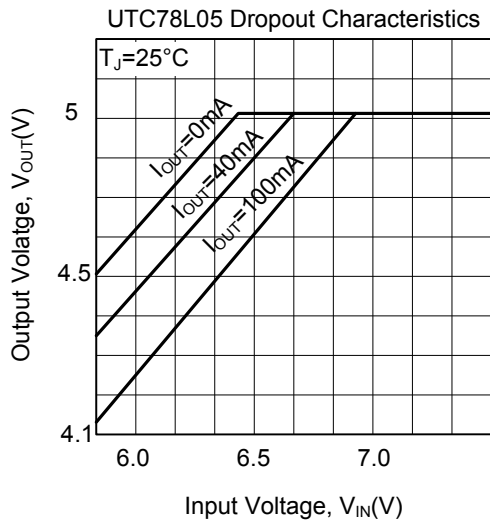
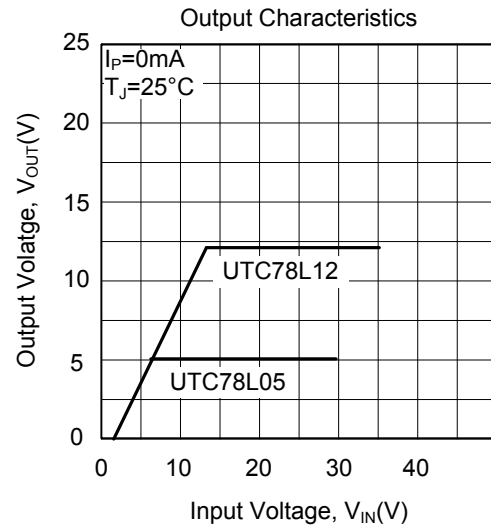
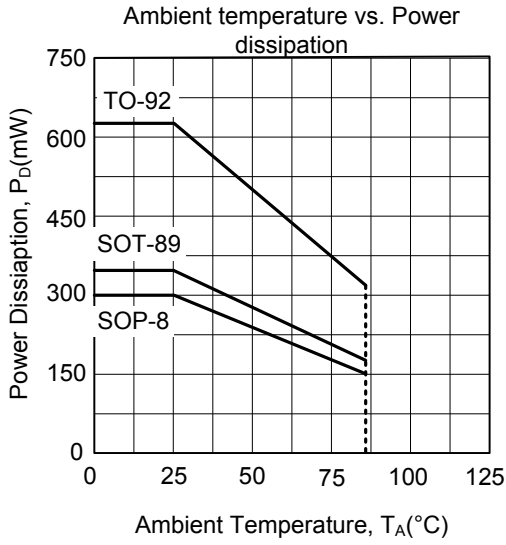

■ TYPICAL CHARACTERISTICS (Cont.)

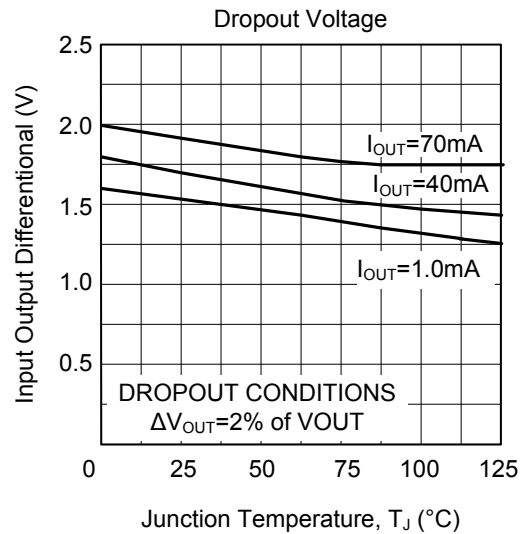
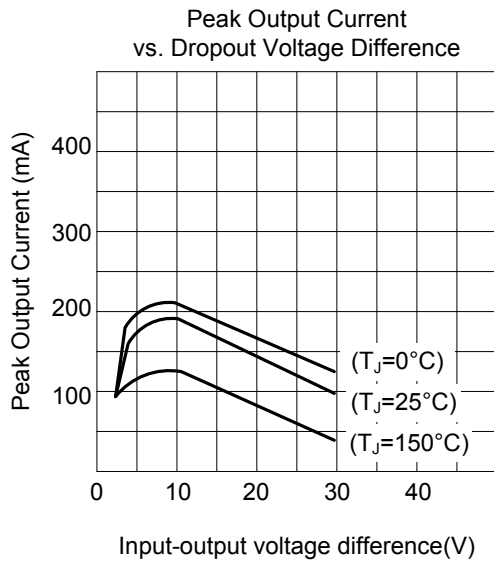

UTC assumes no responsibility for equipment failures that result from using products at values that exceed, even momentarily, rated values (such as maximum ratings, operating condition ranges, or other parameters) listed in products specifications of any and all UTC products described or contained herein. UTC products are not designed for use in life support appliances, devices or systems where malfunction of these products can be reasonably expected to result in personal injury. Reproduction in whole or in part is prohibited without the prior written consent of the copyright owner. UTC reserves the right to make changes to information published in this document, including without limitation specifications and product descriptions, at any time and without notice. This document supersedes and replaces all information supplied prior to the publication hereof.