

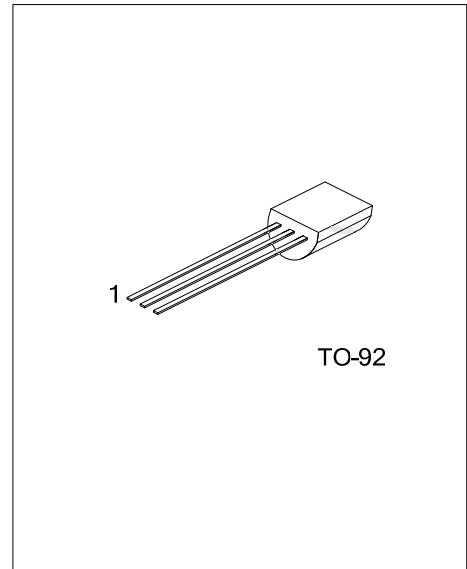

## 9018

## NPNEPITAXIAL PLANAR TRANSISTOR

### AM/FM AMPLIFIER, LOCAL OSCILLATOR OF FM/VHF TUNER



#### FEATURES

\* High Current Gain Bandwidth Product  
 $f_T = 1.1\text{GHz}$  (Typ)

#### ORDERING INFORMATION

Ordering Number		Package	Pin Assignment			Packing
Lead Free	Halogen Free		1	2	3	
9018L-x-T92-B	9018G-x-T92-B	TO-92	E	B	C	Tape Box
9018L-x-T92-K	9018G-x-T92-K	TO-92	E	B	C	Bulk

Note: Pin assignment: E: Emitter B: Base C: Collector

<p>9018L-x-T92-B</p>	<p>(1) B: Tape Box, K: Bulk (2) T92: TO-92 (3) x: refer to Classification of <math>h_{FE}</math> (4) L: Lead Free, G: Halogen Free</p>
----------------------	--

#### MARKING

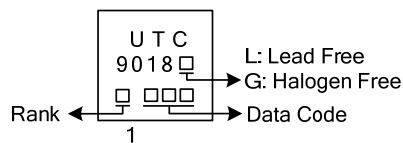

■ ABSOLUTE MAXIMUM RATING ( $T_A=25^\circ\text{C}$ , unless otherwise specified)

PARAMETER	SYMBOL	RATINGS	UNIT
Collector-Base Voltage	$V_{CBO}$	30	V
Collector-Emitter Voltage	$V_{CEO}$	15	V
Emitter-Base Voltage	$V_{EBO}$	5	V
Collector Current	$I_C$	50	mA
Collector Power Dissipation	$P_C$	400	mW
Junction Temperature	$T_J$	125	$^\circ\text{C}$
Operating Temperature	$T_{OPR}$	-20 ~ +85	$^\circ\text{C}$
Storage Temperature	$T_{STG}$	-40 ~ +150	$^\circ\text{C}$

Note: Absolute maximum ratings are those values beyond which the device could be permanently damaged. Absolute maximum ratings are stress ratings only and functional device operation is not implied.

■ ELECTRICAL CHARACTERISTICS ( $T_A=25^\circ\text{C}$ , unless otherwise specified)

PARAMETER	SYMBOL	TEST CONDITIONS	MIN	TYP	MAX	UNIT
Collector-Base Breakdown Voltage	$BV_{CBO}$	$I_C=100\mu\text{A}$ , $I_E=0$	30			V
Collector-Emitter Breakdown Voltage	$BV_{CEO}$	$I_C=1\text{mA}$ , $I_B=0$	15			V
Emitter-Base Breakdown Voltage	$BV_{EBO}$	$I_E=100\mu\text{A}$ , $I_C=0$	5			V
Collector Cut-Off Current	$I_{CBO}$	$V_{CB}=12\text{V}$ , $I_E=0$			50	nA
Collector-Emitter Saturation Voltage	$V_{CE(SAT)}$	$I_C=10\text{mA}$ , $I_B=1\text{mA}$			0.5	V
DC Current Gain	$h_{FE}$	$V_{CE}=5\text{V}$ , $I_C=1\text{mA}$	28	100	198	
Current Gain Bandwidth Product	$f_T$	$V_{CE}=5\text{V}$ , $I_C=5\text{mA}$	700	1100		MHz
Output Capacitance	$C_{OB}$	$V_{CB}=10\text{V}$ , $I_E=0$ , $f=1\text{MHz}$		1.3	1.7	pF

■ CLASSIFICATION of  $h_{FE}$

RANK	D	E	F	G	H	I
RANGE	28-45	39-60	54-80	72-108	97-146	132-198

■ TYPICAL CHARACTERISTICS

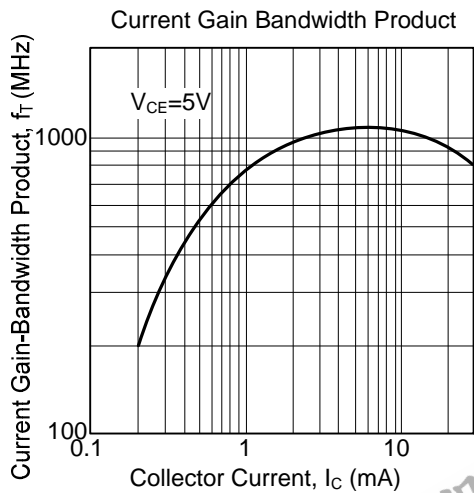
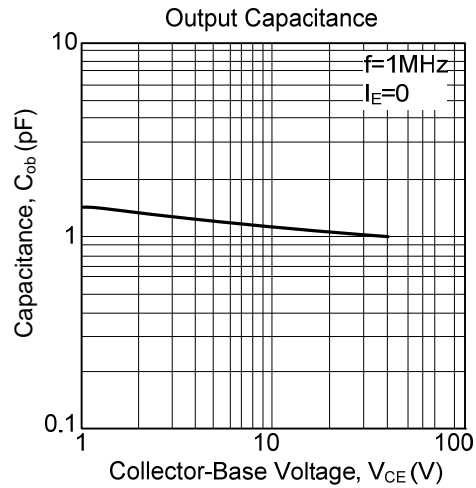
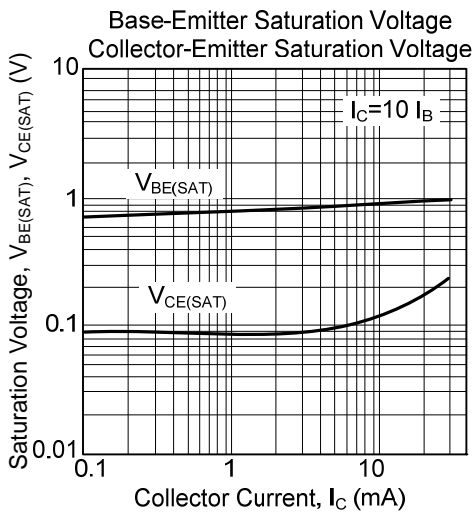
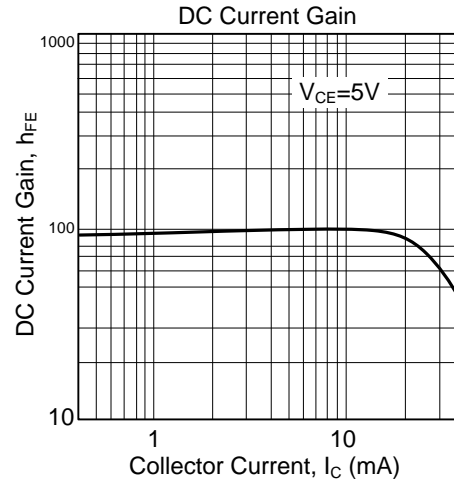
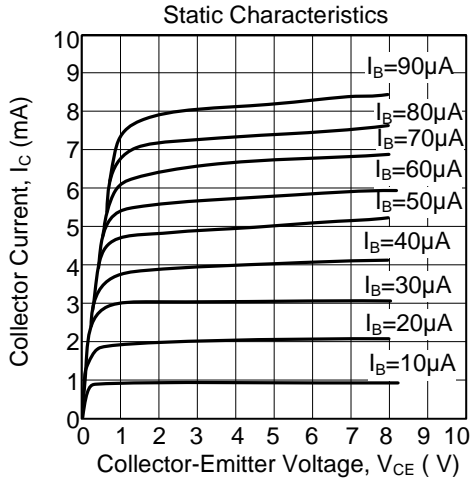

UTC assumes no responsibility for equipment failures that result from using products at values that exceed, even momentarily, rated values (such as maximum ratings, operating condition ranges, or other parameters) listed in products specifications of any and all UTC products described or contained herein. UTC products are not designed for use in life support appliances, devices or systems where malfunction of these products can be reasonably expected to result in personal injury. Reproduction in whole or in part is prohibited without the prior written consent of the copyright owner. The information presented in this document does not form part of any quotation or contract, is believed to be accurate and reliable and may be changed without notice.