



Specification for Approval

- DEVICE NUMBER: BL-BG63V4V

**SAMPLES
ATTACHED AREA**

| DATE \ PAGE | 1 | 2 | 3 | 4 | 5 | | | | | | CONTENTS | |
|-------------|-----|-----|-----|-----|-----|--|--|--|--|--|----------|-------------------|
| 2013/11/11 | 1.0 | 1.0 | 1.0 | 1.0 | 1.0 | | | | | | | Original Released |
| 2015/9/30 | 1.1 | 1.1 | 1.1 | 1.1 | 1.1 | | | | | | | New Version |
| | | | | | | | | | | | | |
| | | | | | | | | | | | | |
| | | | | | | | | | | | | |
| | | | | | | | | | | | | |
| | | | | | | | | | | | | |
| | | | | | | | | | | | | |

FOR CUSTOMER'S APPROVAL STAMP OR SIGNATURE

| APPROVED | PURCHASE | MANUFACTURE | QUALITY | ENGINEERING |
|----------|----------|-------------|---------|-------------|
| | | | | |

佰鴻工業股份有限公司
 BRIGHT LED ELECTRONICS CORP.
 新北市板橋區和平路 19 號 3 樓
 3F., No.19, He Ping Road,
 Ban Qiao Dist., New Taipei City,
 Taiwan
 Tel: +886-2-29591090
 Fax: +886-2-29547006/29558809
www.briled.com

| ISSUED | APPROVED | PREPARED |
|--------|----------|----------|
| | | |

● Features:

1. Chip material: InGaN
2. Emitted color : Green
3. Lens Appearance : Water Clear
4. Low power consumption.
5. High efficiency.
6. Versatile mounting on P.C. Board or panel.
7. Low current requirement.
8. 5mm diameter package.
9. This product don't contained restriction substance, compliance RoHS standard.

● Applications:

1. TV set
2. Monitor
3. Telephone
4. Computer
5. Circuit board

● Package dimensions:

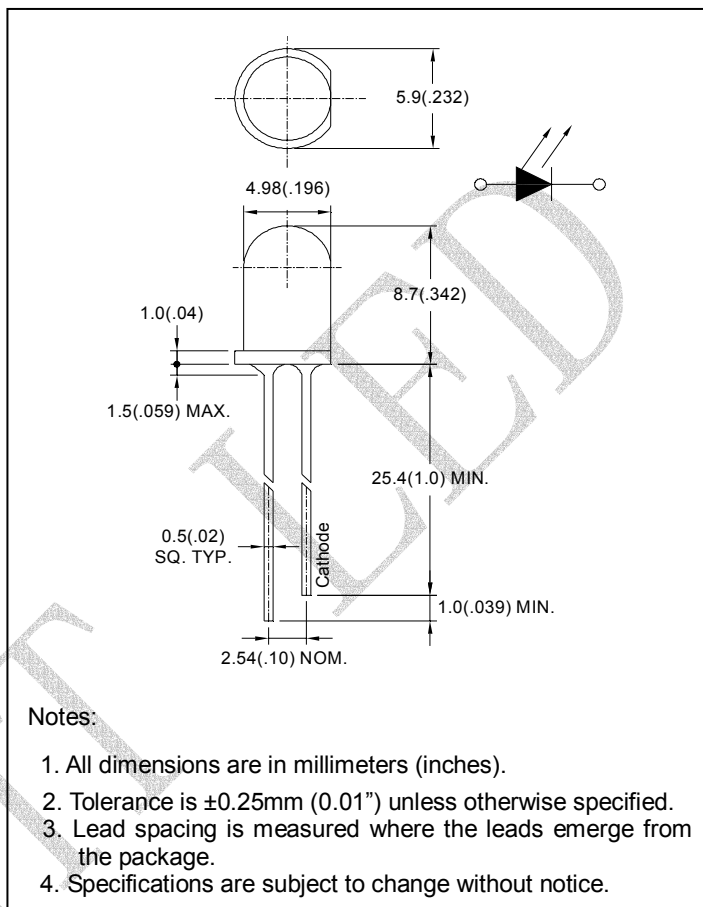

● Absolute Maximum Ratings($T_a=25^\circ\text{C}$)

| Parameter | Symbol | Rating | Unit |
|-----------------------|-----------|---|------|
| Power Dissipation | P_d | 110 | mW |
| Forward Current | I_F | 30 | mA |
| Peak Forward Current | I_{FP} | 150 | mA |
| Reverse Voltage | V_R | 5 | V |
| Operating Temperature | T_{opr} | $-40^\circ\text{C} \sim 85^\circ\text{C}$ | |
| Storage Temperature | T_{stg} | $-40^\circ\text{C} \sim 85^\circ\text{C}$ | |

*¹Condition for I_{FP} is pulse of 1/10 duty and 0.1msec width.

● Electrical and optical characteristics(Ta=25°C)

| Parameter | Symbol | Condition | Min. | Typ. | Max. | Unit |
|--------------------------|-----------------|-------------------|------|-------|------|---------------|
| Forward Voltage | V_F | $I_F=20\text{mA}$ | - | 3.2 | 3.6 | V |
| Luminous Intensity | I_v | $I_F=20\text{mA}$ | - | 21700 | - | mcd |
| Reverse Current | I_R | $V_R=5\text{V}$ | - | - | 100 | μA |
| Peak Wave Length | λ_p | $I_F=20\text{mA}$ | - | 525 | - | nm |
| Dominant Wave Length | λ_d | $I_F=20\text{mA}$ | 515 | - | 535 | nm |
| Spectral Line Half-width | $\Delta\lambda$ | $I_F=20\text{mA}$ | - | 35 | - | nm |
| Viewing Angle | $2\theta_{1/2}$ | $I_F=20\text{mA}$ | - | 15 | - | deg |

● Typical electro-optical characteristics curves

Fig.1 Relative intensity vs. Wavelength

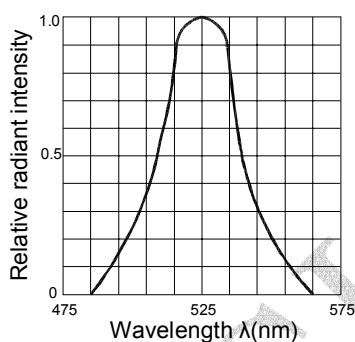

Fig.2 Forward current derating curve vs. Ambient temperature

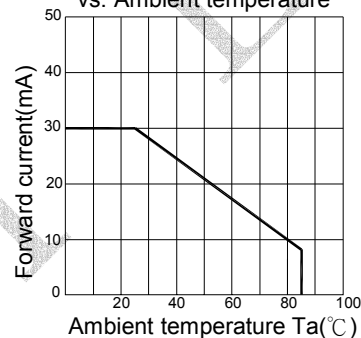

Fig.3 Forward current vs. Forward voltage

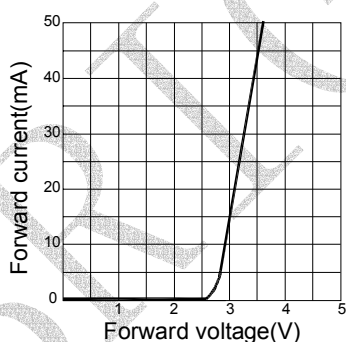

Fig.4 Relative luminous intensity vs. Ambient temperature

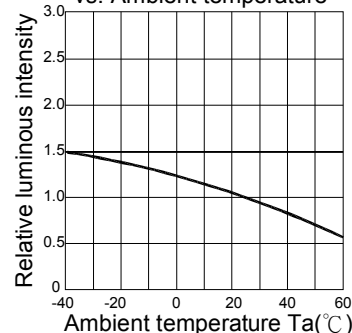

Fig.5 Relative luminous intensity vs. Forward current

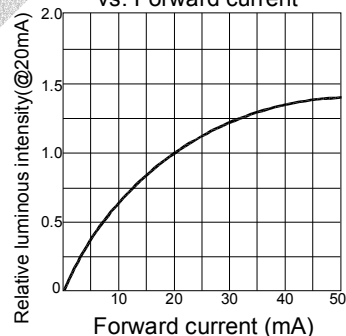
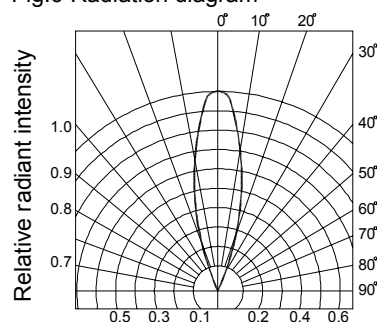

Fig.6 Radiation diagram



● Bin Limits

1. Intensity Bin Limits (At $I_F=20\text{mA}$)

| Bin Code | Min. (mcd) | Max. (mcd) |
|----------|------------|------------|
| ZB | 8325 | 12488 |
| ZC | 12488 | 18731 |
| ZD | 18731 | 28097 |
| ZE | 28097 | 42145 |
| ZF | 42145 | 63218 |

2. Color Bin Limits (At $I_F=20\text{mA}$) : Dominant Wave Length $\lambda_d(\text{nm})$

| Bin Code | Min. (nm) | Max. (nm) |
|----------|-----------|-----------|
| 5 | 515 | 520 |
| 6 | 520 | 525 |
| 7 | 525 | 530 |
| 8 | 530 | 535 |



NOTES: 1. Tolerance of measurement of luminous intensity. :±15%

2. Tolerance of measurement of dominant wavelength :±1.0nm

● Reliability Test

| Classification | Test Item | Reference Standard | Test Conditions | Result |
|--------------------|--|---|--|--------|
| Endurance Test | Operation Life | MIL-STD-750:1026 MIL-STD-883:1005 JIS-C-7021 :B-1 | I _F =20mA Ta=+25°C±5°C Test time=1,000hrs | 0/32 |
| | High Temperature High Humidity Storage | MIL-STD-202:103B JIS-C-7021 :B-11 | Ta=+85°C±5°C RH=90%-95% Test time=240hrs | 0/32 |
| | High Temperature Storage | MIL-STD-883:1008 JIS-C-7021 :B-10 | High Ta=+85°C±5°C Test time=1,000hrs | 0/32 |
| | Low Temperature Storage | JIS-C-7021 :B-12 | Low Ta=-45°C±5°C Test time=1,000hrs | 0/32 |
| Environmental Test | Temperature Cycling | MIL-STD-202:107D MIL-STD-750:1051 MIL-STD-883:1010 JIS-C-7021 :A-4 | Ta: +85°C (30min) ~ +25°C (5min) ~ -45°C (30min) ~ +25°C (5min) Test Time : 70min/ctcle 10cycle | 0/32 |
| | Thermal Shock | MIL-STD-202:107D MIL-STD-750:1051 MIL-STD-883:1011 | -45°C±5°C ~+85°C±5°C 20min 20min Test Time=10cycle | 0/32 |
| | Solder Resistance | MIL-STD-202:201A MIL-STD-750:2031 JIS-C-7021 :A-1 | Preheating : 120°C, within 120-180 sec. Operation heating : 255°C±5°C within 5 sec. 260°C (Max) | 0/32 |
| | Solderability | MIL-STD-202F:208D MIL-STD-750D:2026 MIL-STD-883D:2003 JIS C 7021:A-2 | T.sol=230±5°C Dwell Time=5±1secs | 0/32 |

● Judgment criteria of failure for the reliability

| Measuring items | Symbol | Measuring conditions | Judgment criteria for failure |
|--------------------|-----------------------|----------------------|-------------------------------|
| Forward voltage | V _F (V) | I _F =20mA | Over U ¹ x1.2 |
| Reverse current | I _R (uA) | V _R =5V | Over U ¹ x2 |
| Luminous intensity | I _v (mcd) | I _F =20mA | Below S ¹ X0.5 |

Note: 1. U means the upper limit of specified characteristics. S means initial value.

2. Measurement shall be taken between 2 hours and after the test pieces have been returned to normal ambient conditions after completion of each test.

● Dip Soldering

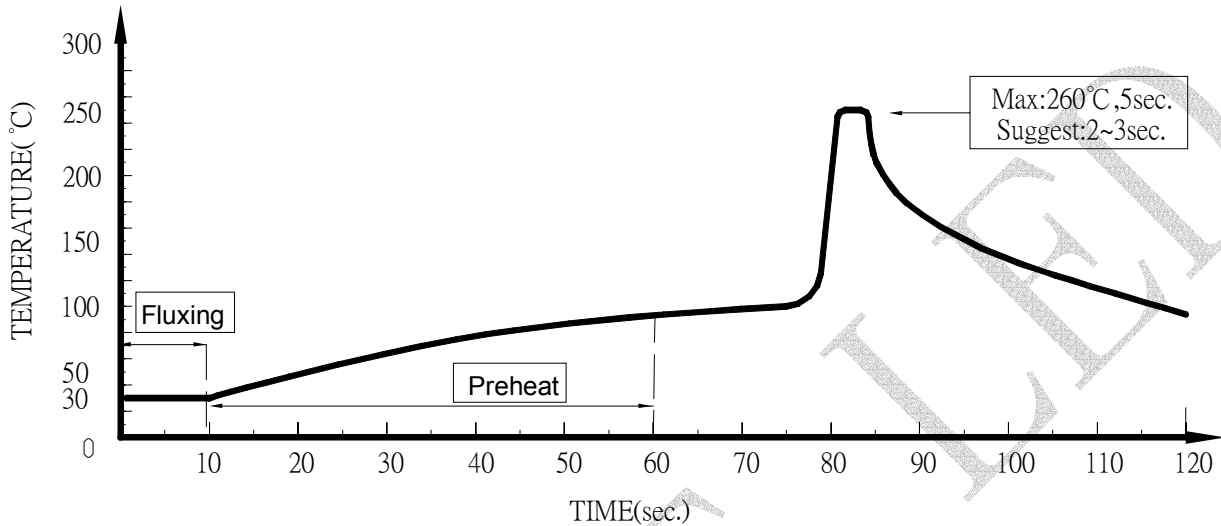

1. Please avoid any external stress applied to the lead-frames and epoxy while the LEDs are at high temperature, especially during soldering
2. DIP soldering and hand soldering should not be done more than one time.
3. After soldering, avoid the epoxy lens from mechanical shock or vibration until the LEDs are back to room temperature.
4. Avoid rapid cooling during temperature ramp-down process
5. Although the soldering condition is recommended above, soldering at the lowest possible temperature is feasible for the LEDs

● IRON Soldering

300°C Within 3 sec., One time only.