



## Specification for Approval

- DEVICE NUMBER: BL-BGEJE204

SAMPLES  
ATTACHED AREA

| DATE \ PAGE | 1   | 2   | 3   | 4   |  |  |  |  |  |  |  | CONTENTS         |
|-------------|-----|-----|-----|-----|--|--|--|--|--|--|--|------------------|
| 2015/11/6   | 1.0 | 1.0 | 1.0 | 1.0 |  |  |  |  |  |  |  | Initial Released |
|             |     |     |     |     |  |  |  |  |  |  |  |                  |
|             |     |     |     |     |  |  |  |  |  |  |  |                  |
|             |     |     |     |     |  |  |  |  |  |  |  |                  |
|             |     |     |     |     |  |  |  |  |  |  |  |                  |
|             |     |     |     |     |  |  |  |  |  |  |  |                  |
|             |     |     |     |     |  |  |  |  |  |  |  |                  |
|             |     |     |     |     |  |  |  |  |  |  |  |                  |

### FOR CUSTOMER'S APPROVAL STAMP OR SIGNATURE

| APPROVED | PURCHASE | MANUFACTURE | QUALITY | ENGINEERING |
|----------|----------|-------------|---------|-------------|
|          |          |             |         |             |

佰鴻工業股份有限公司  
 BRIGHT LED ELECTRONICS CORP.  
 新北市板橋區和平路 19 號 3 樓  
 3F., No.19, He Ping Road,  
 Ban Qiao Dist., New Taipei City,  
 Taiwan  
 Tel: +886-2-29591090  
 Fax: +886-2-29547006/29558809  
[www.brtled.com](http://www.brtled.com)

| ISSUED | APPROVED | PREPARED |
|--------|----------|----------|
|        |          |          |

### ● Features:

1. Chip material: AlGaInP/GaAs (Green)  
and AlGaInP/GaAs(Orange)
2. Emitted color : Green and Super Orange
3. Lens Appearance : White Diffused
4. Low power consumption.
5. High efficiency.
6. Versatile mounting on P.C. Board or panel.
7. Low current requirement.
8. 5mm diameter package.
9. This product don't contained restriction substance, compliance RoHS standard.

### ● Applications:

1. TV set
2. Monitor
3. Telephone
4. Computer
5. Circuit board

### ● Package dimensions

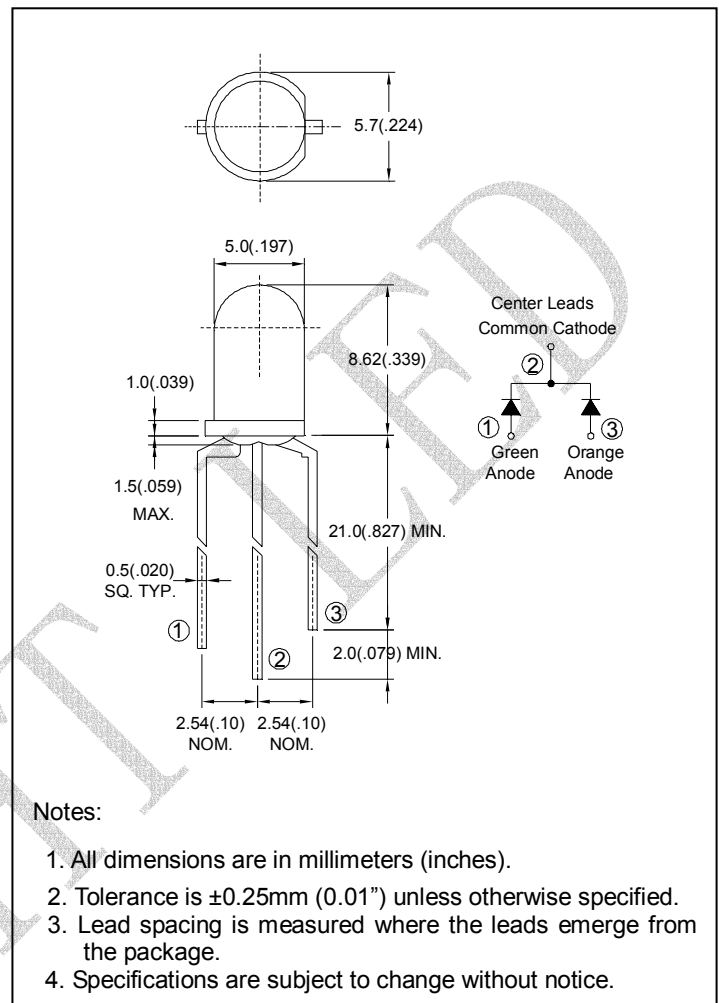

### ● Absolute Maximum Ratings(Ta=25°C)

| Parameter             | Symbol          | Green       | Orange | Unit |
|-----------------------|-----------------|-------------|--------|------|
| Power Dissipation     | Pd              | 80          | 80     | mW   |
| Forward Current       | I <sub>F</sub>  | 30          | 30     | mA   |
| Peak Forward Current  | I <sub>FP</sub> | 150         | 150    | mA   |
| Reverse Voltage       | V <sub>R</sub>  | 5           |        | V    |
| Operating Temperature | Topr            | -40°C ~85°C |        |      |
| Storage Temperature   | Tstg            | -40°C ~85°C |        |      |

\*1 Condition for I<sub>FP</sub> is pulse of 1/10 duty and 0.1msec width.

● **Electrical and optical characteristics(Ta=25°C)**

| Parameter                | Symbol           | Condition  | Color           | Min.       | Typ.       | Max.       | Unit    |
|--------------------------|------------------|------------|-----------------|------------|------------|------------|---------|
| Forward Voltage          | $V_F$            | $I_F=20mA$ | Green<br>Orange | -          | 2.0<br>2.0 | 2.6<br>2.6 | V       |
| Luminous Intensity       | $I_v$            | $I_F=20mA$ | Green<br>Orange | -          | 120<br>550 | -          | mcd     |
| Reverse Current          | $I_R$            | $V_R=5V$   | Green<br>Orange | -          | -          | 100        | $\mu A$ |
| Peak Wave Length         | $\lambda_p$      | $I_F=20mA$ | Green<br>Orange | -          | 570<br>630 | -          | nm      |
| Dominant Wave Length     | $\lambda_d$      | $I_F=20mA$ | Green<br>Orange | 560<br>615 | -<br>-     | 574<br>628 | nm      |
| Spectral Line Half-width | $\Delta \lambda$ | $I_F=20mA$ | Green<br>Orange | -          | 30<br>17   | -          | nm      |
| Viewing Angle            | $2\theta_{1/2}$  | $I_F=20mA$ | Green<br>Orange | -          | 50         | -          | deg     |

● **Typical Electro-Optical Characteristics Curves**

Fig.1 Relative intensity vs. Wavelength

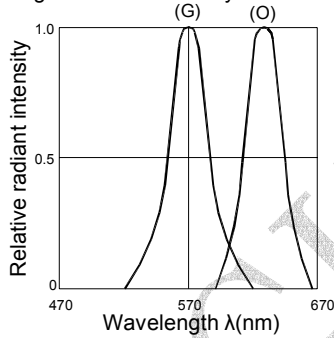

Fig.2 Forward current derating curve vs. Ambient temperature

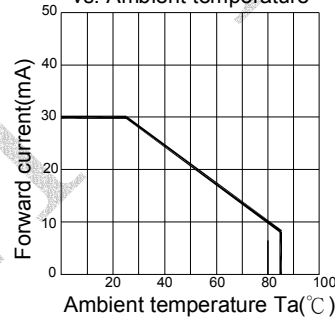

Fig.3 Forward current vs. Forward voltage

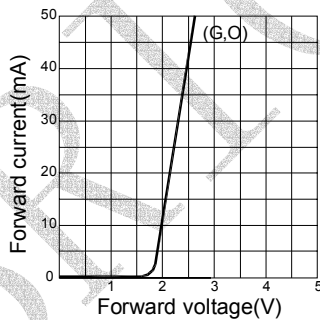

Fig.4 Relative luminous intensity vs. Ambient temperature

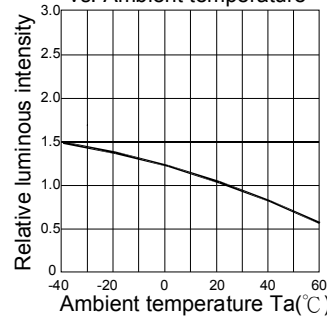

Fig.5 Relative luminous intensity vs. Forward current

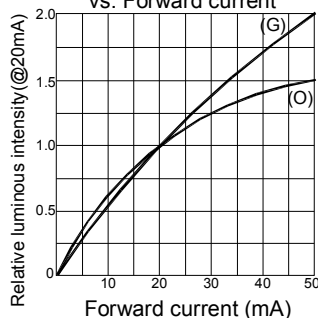
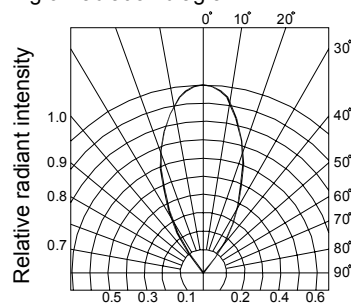

Fig.6 Radiation diagram



## ● Reliability Test

| Classification     | Test Item                              | Reference Standard  | Test Conditions  | Result |
|--------------------|--|---|--|--------|
| Endurance Test     | Operation Life                         | MIL-STD-750:1026<br>MIL-STD-883:1005<br>JIS-C-7021 :B-1                       | I <sub>F</sub> =20mA<br>T <sub>a</sub> =+25°C±5°C<br>Test time=1,000hrs  | 0/32   |
|                    | High Temperature High Humidity Storage | MIL-STD-202:103B<br>JIS-C-7021 :B-11  | T <sub>a</sub> =+85°C±5°C<br>RH=90%-95%<br>Test time=240hrs  | 0/32   |
|                    | High Temperature Storage               | MIL-STD-883:1008<br>JIS-C-7021 :B-10  | High T <sub>a</sub> =+85°C±5°C<br>Test time=1,000hrs   | 0/32   |
|                    | Low Temperature Storage                | JIS-C-7021 :B-12  | Low T <sub>a</sub> =-45°C±5°C<br>Test time=1,000hrs  | 0/32   |
| Environmental Test | Temperature Cycling                    | MIL-STD-202:107D<br>MIL-STD-750:1051<br>MIL-STD-883:1010<br>JIS-C-7021 :A-4   | T <sub>a</sub> : +85°C (30min) ~ +25°C (5min) ~<br>-45°C (30min) ~ +25°C (5min)<br>Test Time : 70min/ctcle 10cycle | 0/32   |
|                    | Thermal Shock                          | MIL-STD-202:107D<br>MIL-STD-750:1051<br>MIL-STD-883:1011                      | -45°C±5°C ~+85°C±5°C<br>20min 20min<br>Test Time=10cycle   | 0/32   |
|                    | Solder Resistance                      | MIL-STD-202:201A<br>MIL-STD-750:2031<br>JIS-C-7021 :A-1                       | Preheating :<br>120°C, within 120-180 sec.<br>Operation heating :<br>255°C±5°C within 5 sec. 260°C (Max)           | 0/32   |
|                    | Solderability                          | MIL-STD-202F:208D<br>MIL-STD-750D:2026<br>MIL-STD-883D:2003<br>JIS C 7021:A-2 | T <sub>sol</sub> =230±5°C<br>Dwell Time=5±1secs  | 0/32   |

## ● Judgment criteria of failure for the reliability

| Measuring items    | Symbol                | Measuring conditions | Judgment criteria for failure |
|--------------------|-----------------------|----------------------|-------------------------------|
| Forward voltage    | V <sub>F</sub> (V)    | I <sub>F</sub> =20mA | Over U <sup>1</sup> x1.2      |
| Reverse current    | I <sub>R</sub> (uA)   | V <sub>R</sub> =5V   | Over U <sup>1</sup> x2        |
| Luminous intensity | I <sub>v</sub> ( mcd) | I <sub>F</sub> =20mA | Below S <sup>1</sup> X0.5     |

Note: 1. U means the upper limit of specified characteristics. S means initial value.

2. Measurement shall be taken between 2 hours and after the test pieces have been returned to normal ambient conditions after completion of each test.

## ● Dip Soldering

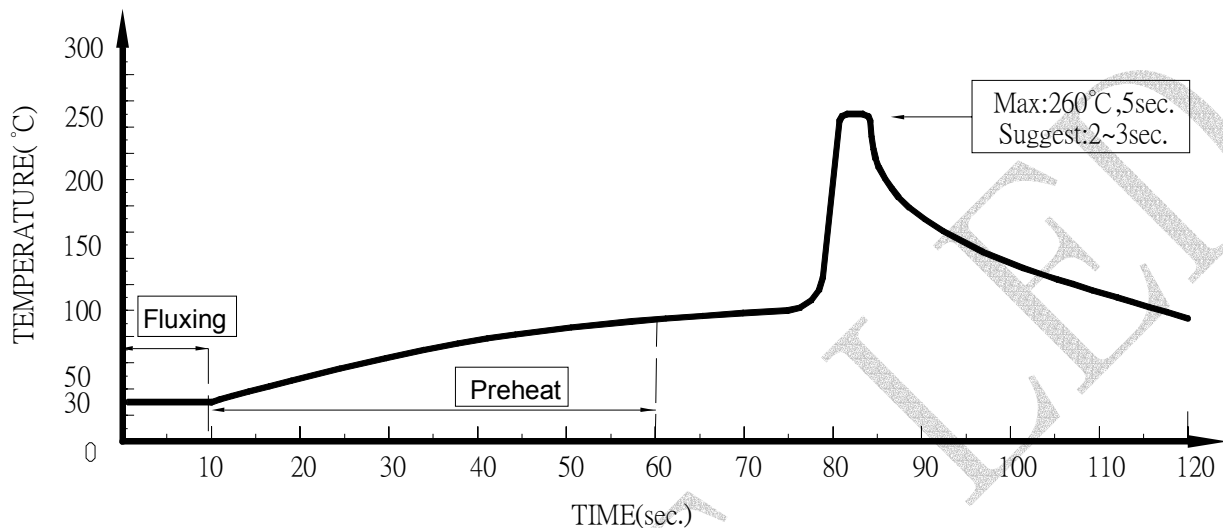

1. Please avoid any external stress applied to the lead-frames and epoxy while the LEDs are at high temperature, especially during soldering
2. DIP soldering and hand soldering should not be done more than one time.
3. After soldering, avoid the epoxy lens from mechanical shock or vibration until the LEDs are back to room temperature.
4. Avoid rapid cooling during temperature ramp-down process
5. Although the soldering condition is recommended above, soldering at the lowest possible temperature is feasible for the LEDs

## ● IRON Soldering

**300°C Within 3 sec., One time only.**