



## Specification for Approval

- DEVICE NUMBER: BL-C4532

**SAMPLES  
ATTACHED AREA**

DATE \ PAGE	1	2	3	4							CONTENTS
2008/9/5	1.0	1.0	1.0								Original Released
2014/2/21	1.1	1.1	1.1	1.1							Modify λd
2015/9/15	1.2	1.2	1.2	1.2							New Version

### FOR CUSTOMER'S APPROVAL STAMP OR SIGNATURE

APPROVED	PURCHASE	MANUFACTURE	QUALITY	ENGINEERING

佰鴻工業股份有限公司  
 BRIGHT LED ELECTRONICS CORP.  
 新北市板橋區和平路 19 號 3 樓  
 3F., No.19, He Ping Road,  
 Ban Qiao Dist., New Taipei City,  
 Taiwan  
 Tel: +886-2-29591090  
 Fax: +886-2-29547006/29558809  
[www.briled.com](http://www.briled.com)

ISSUED	APPROVED	PREPARED

● **Features:**

1. Chip material: GaAsP/GaP
2. Emitted color : Hi-Eff Red
3. Lens Appearance : Red Diffused
4. Cylindrical shape.
5. Low power consumption.
6. Compatible
7. Long life solid state reliability.
8. This product don't contained restriction substance, compliance RoHS standard.

● **Applications:**

1. TV set
2. Monitor
3. Telephone
4. Computer
5. Circuit board

● **Package dimensions:**

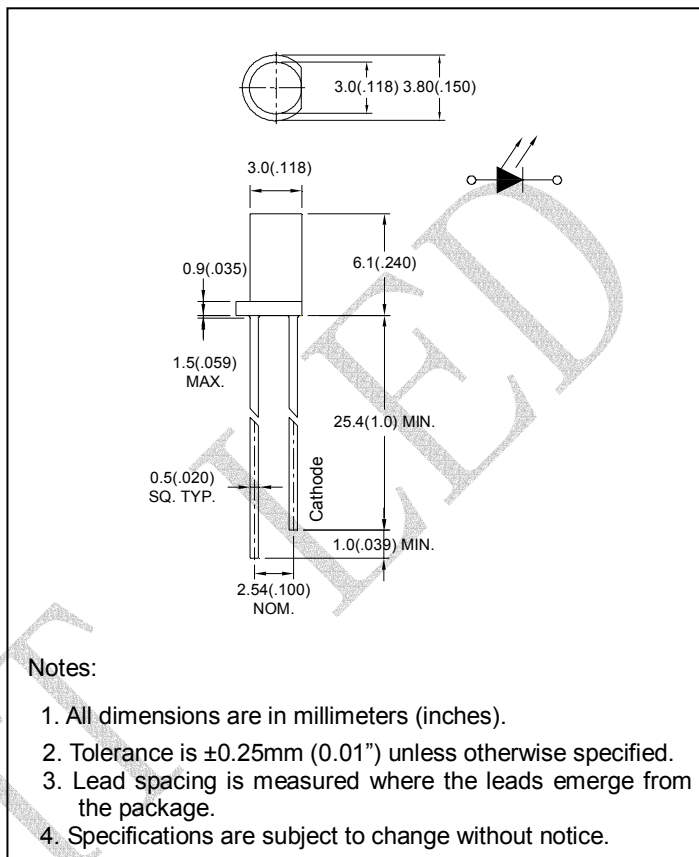

● **Absolute Maximum Ratings(Ta=25°C)**

Parameter	Symbol	Rating	Unit
Power Dissipation	Pd	80	mW
Forward Current	I <sub>F</sub>	30	mA
Peak Forward Current* <sup>1</sup>	I <sub>FP</sub>	150	mA
Reverse Voltage	V <sub>R</sub>	5	V
Operating Temperature	Topr	-40°C~85°C	
Storage Temperature	Tstg	-40°C~85°C	

\*<sup>1</sup>Condition for I<sub>FP</sub> is pulse of 1/10 duty and 0.1msec width.

## ● Electrical and optical characteristics(Ta=25°C)

Parameter	Symbol	Condition	Min.	Typ.	Max.	Unit
Forward Voltage	V <sub>F</sub>	I <sub>F</sub> =20mA	-	2.1	2.6	V
Luminous Intensity	I <sub>v</sub>	I <sub>F</sub> =20mA	-	8.0	-	mcd
Reverse Current	I <sub>R</sub>	V <sub>R</sub> =5V	-	-	100	μA
Peak Wave Length	λ <sub>p</sub>	I <sub>F</sub> =20mA	-	640	-	nm
Dominant Wave Length	λ <sub>d</sub>	I <sub>F</sub> =20mA	617	-	638	nm
Spectral Line Half-width	Δλ	I <sub>F</sub> =20mA	-	40	-	nm
Viewing Angle	2θ <sub>1/2</sub>	I <sub>F</sub> =20mA	-	130	-	deg

## ● Typical Electro-Optical Characteristics Curves

Fig.1 Relative intensity vs. Wavelength

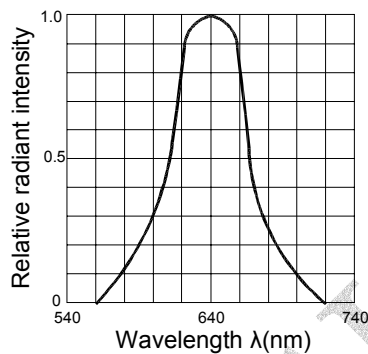

Fig.2 Forward current derating curve vs. Ambient temperature

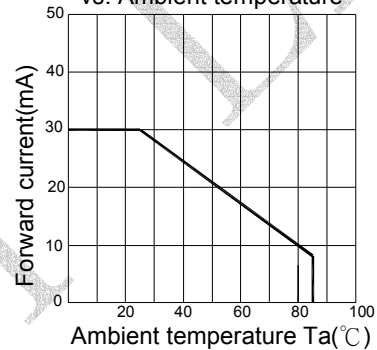

Fig.3 Forward current vs. Forward voltage

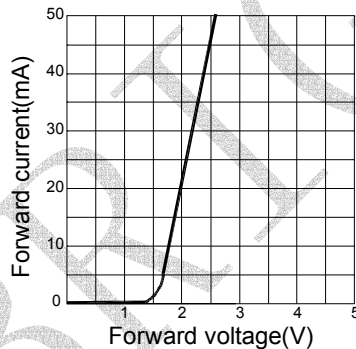

Fig.4 Relative luminous intensity vs. Ambient temperature

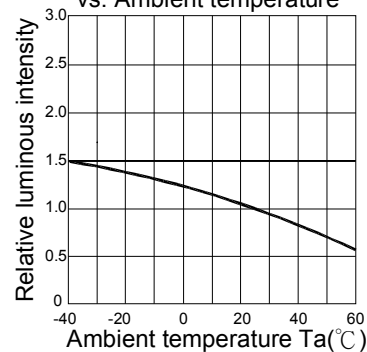

Fig.5 Relative luminous intensity vs. Forward current

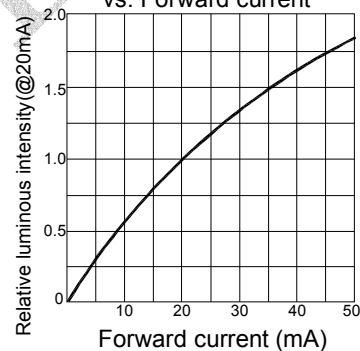
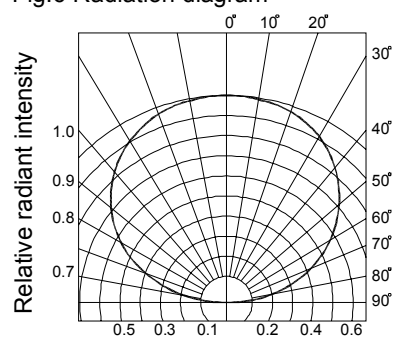

Fig.6 Radiation diagram



## ● Reliability Test

Classification	Test Item	Reference Standard	Test Conditions	Result
Endurance Test	Operation Life	MIL-STD-750:1026 MIL-STD-883:1005 JIS-C-7021 :B-1	I <sub>F</sub> =20mA Ta=+25°C±5°C Test time=1,000hrs	0/32
	High Temperature High Humidity Storage	MIL-STD-202:103B JIS-C-7021 :B-11	Ta=+85°C±5°C RH=90%-95% Test time=240hrs	0/32
	High Temperature Storage	MIL-STD-883:1008 JIS-C-7021 :B-10	High Ta=+85°C±5°C Test time=1,000hrs	0/32
	Low Temperature Storage	JIS-C-7021 :B-12	Low Ta=-45°C±5°C Test time=1,000hrs	0/32
Environmental Test	Temperature Cycling	MIL-STD-202:107D MIL-STD-750:1051 MIL-STD-883:1010 JIS-C-7021 :A-4	Ta: +85°C (30min) ~ +25°C (5min) ~ -45°C (30min) ~ +25°C (5min) Test Time : 70min/ctcle 10cycle	0/32
	Thermal Shock	MIL-STD-202:107D MIL-STD-750:1051 MIL-STD-883:1011	-45°C±5°C ~+85°C±5°C 20min 20min Test Time=10cycle	0/32
	Solder Resistance	MIL-STD-202:201A MIL-STD-750:2031 JIS-C-7021 :A-1	Preheating : 120°C, within 120-180 sec. Operation heating : 255°C±5°C within 5 sec. 260°C (Max)	0/32
	Solderability	MIL-STD-202F:208D MIL-STD-750D:2026 MIL-STD-883D:2003 JIS C 7021:A-2	T.sol=230±5°C Dwell Time=5±1secs	0/32

## ● Judgment criteria of failure for the reliability

Measuring items	Symbol	Measuring conditions	Judgment criteria for failure
Forward voltage	V <sub>F</sub> (V)	I <sub>F</sub> =20mA	Over U <sup>1</sup> x1.2
Reverse current	I <sub>R</sub> (uA)	V <sub>R</sub> =5V	Over U <sup>1</sup> x2
Luminous intensity	I <sub>v</sub> ( mcd)	I <sub>F</sub> =20mA	Below S <sup>1</sup> X0.5

Note: 1. U means the upper limit of specified characteristics. S means initial value.

2. Measurement shall be taken between 2 hours and after the test pieces have been returned to normal ambient conditions after completion of each test.

## ● Dip Soldering

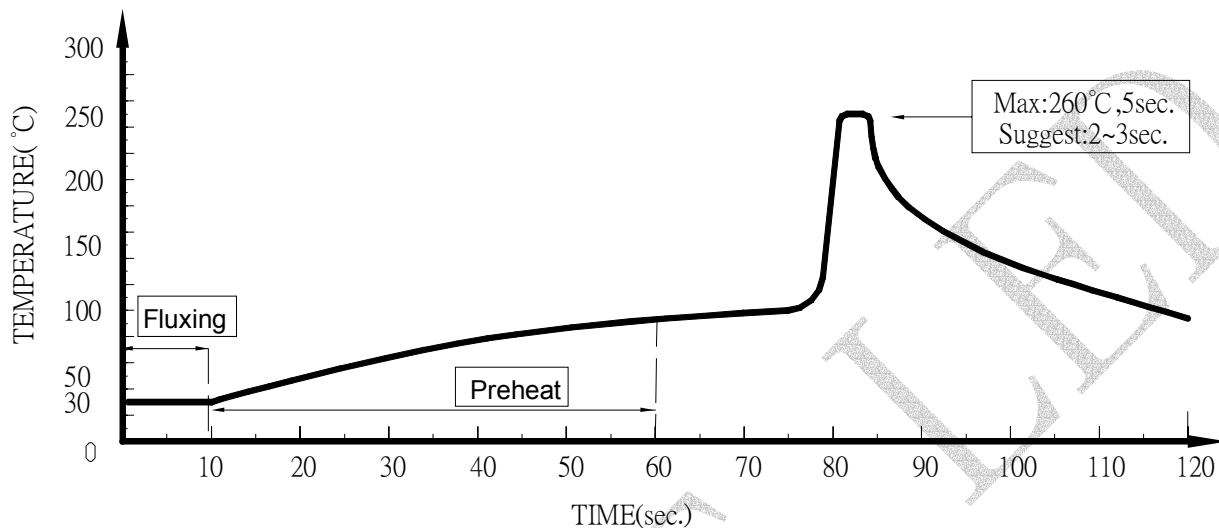

1. Please avoid any external stress applied to the lead-frames and epoxy while the LEDs are at high temperature, especially during soldering
2. DIP soldering and hand soldering should not be done more than one time.
3. After soldering, avoid the epoxy lens from mechanical shock or vibration until the LEDs are back to room temperature.
4. Avoid rapid cooling during temperature ramp-down process
5. Although the soldering condition is recommended above, soldering at the lowest possible temperature is feasible for the LEDs

## ● IRON Soldering

**300°C Within 3 sec., One time only.**