



Specification for Approval

- DEVICE NUMBER: BL-HZD36A-LB6.5-TRB

**SAMPLES
ATTACHED AREA**

DATE \ PAGE	1	2	3	4	5	6	7	8	9	10	CONTENTS
2015.11.23	1.0	1.0	1.0	1.0	1.0	1.0	1.0	1.0	1.0	1.0	Initial Released

FOR CUSTOMER'S APPROVAL STAMP OR SIGNATURE

APPROVED	PURCHASE	MANUFACTURE	QUALITY	ENGINEERING

佰鴻工業股份有限公司
 BRIGHT LED ELECTRONICS CORP.
 新北市板橋區和平路 19 號 3 樓
 3F., No.19, He Ping Road,
 Ban Qiao Dist., New Taipei City,
 Taiwan
 Tel: +886-2-29591090

ISSUED	APPROVED	PREPARED

● Features:

1. Emitted Color : White
2. Mono-color type.
3. 1.6x0.8x0.6mm(0603) standard package.
4. Suitable for all SMT assembly methods.
5. Compatible with infrared and vapor phase reflow solder process.
6. Compatible with automatic placement equipment.
7. This product doesn't contain restriction Substance, comply ROHS standard

● Applications:

1. Automotive : Dashboards, stop lamps, turn signals.
2. Backlighting : LCDs, Key pads advertising.
3. Status indicators : Consumer & industrial electronics.
4. General use.

● Package Dimensions:

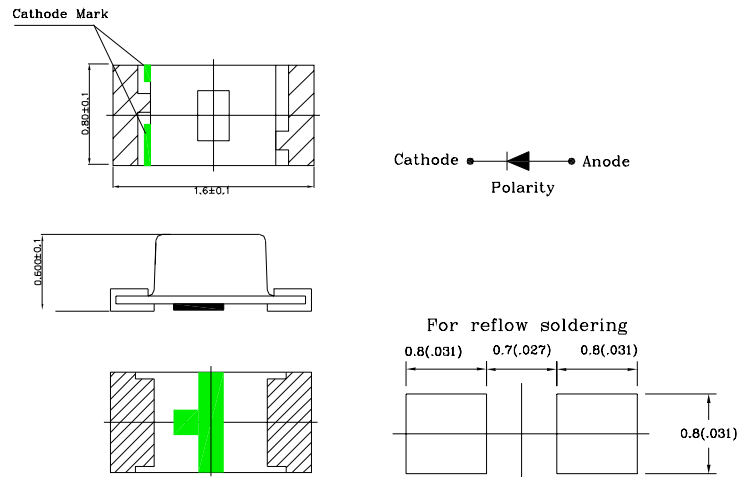

NOTES:

1. All dimensions are in millimeters (inches).
2. Tolerance is $\pm 0.10\text{mm}$ (0.004") unless otherwise specified.
3. Specifications are subject to change without notice.

● Absolute Maximum Ratings(Ta=25°C)

Parameter	Symbol	Rating	Unit
Power Dissipation	Pd	70	mW
Forward Current	I _F	20	mA
Peak Forward Current * 1	I _{FP}	100	mA
Reverse Voltage	V _R	5	V
Operating Temperature	Topr	-40°C~85°C	-
Storage Temperature	Tstg	-40°C~85°C	-
Soldering Temperature	Tsol	See Page8	-

* 1 Condition for I_{FP} is pulse of 1/10 duty and 0.1msec width.

● Electrical and optical characteristics(Ta=25°C)

Parameter	Symbol	Condition	Min.	Typ.	Max.	Unit
Forward Voltage	V _f	I _F =20mA	-	3.2	3.6	V
Luminous Intensity	I _v	I _F =20mA	317	715	-	mcd
Reverse Current	I _R	V _R =5V	-	-	1	μA
Chromaticity Coordinates	x	I _F =20mA	-	0.28	-	nm
	y	I _F =20mA	-	0.29	-	nm
Spectral Line Half-width	Δλ	I _F =20mA	-	25	-	nm
Viewing Angle	2θ _{1/2}	I _F =20mA	-	120	-	deg

● Typical Electro-Optical Characteristics Curves

Fig.1 Relative intensity vs. wavelength

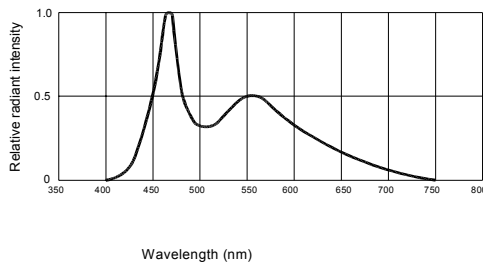

Fig.2 Forward current derating curve vs. ambient temperature

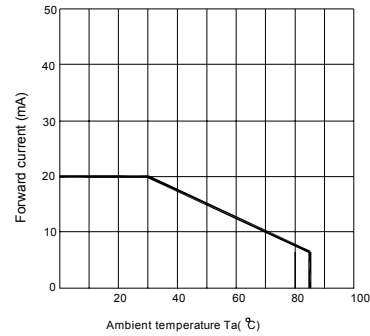

Fig.3 Forward current vs. forward voltage

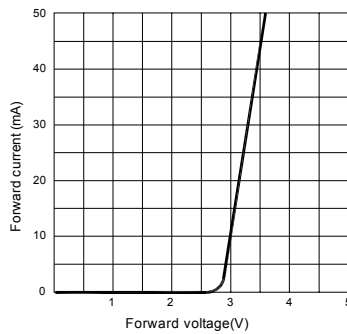

Fig.4 Relative luminous intensity vs. ambient temperature

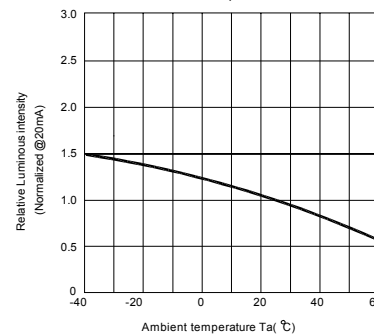

Fig.5 Relative luminous intensity vs. forward current

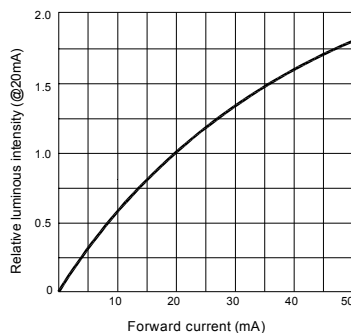
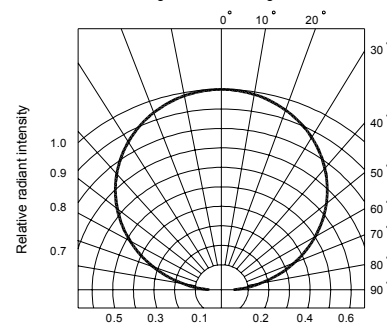
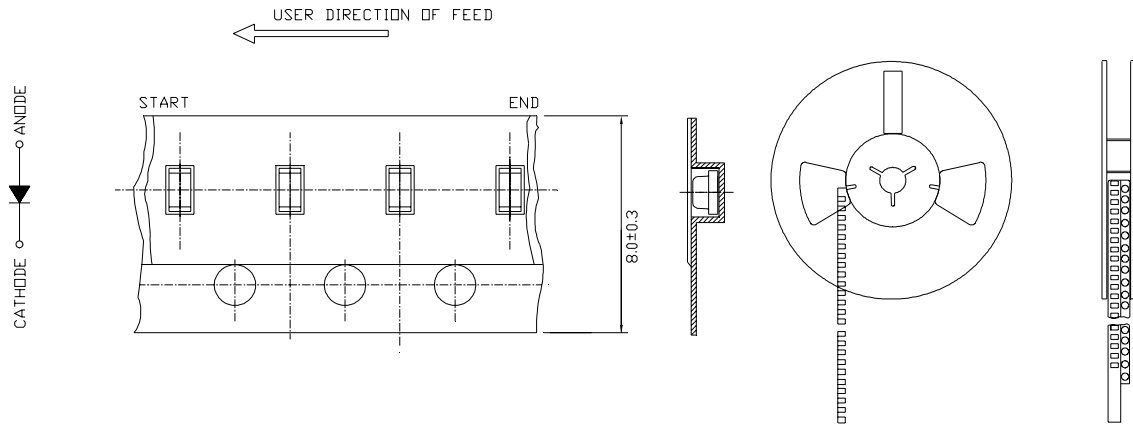

Fig.6 Radiation diagram



● Tapping and packaging specifications(Units: mm)

Quantity:1000-4000PCS



● Package Method:(unit:mm) Vacuum

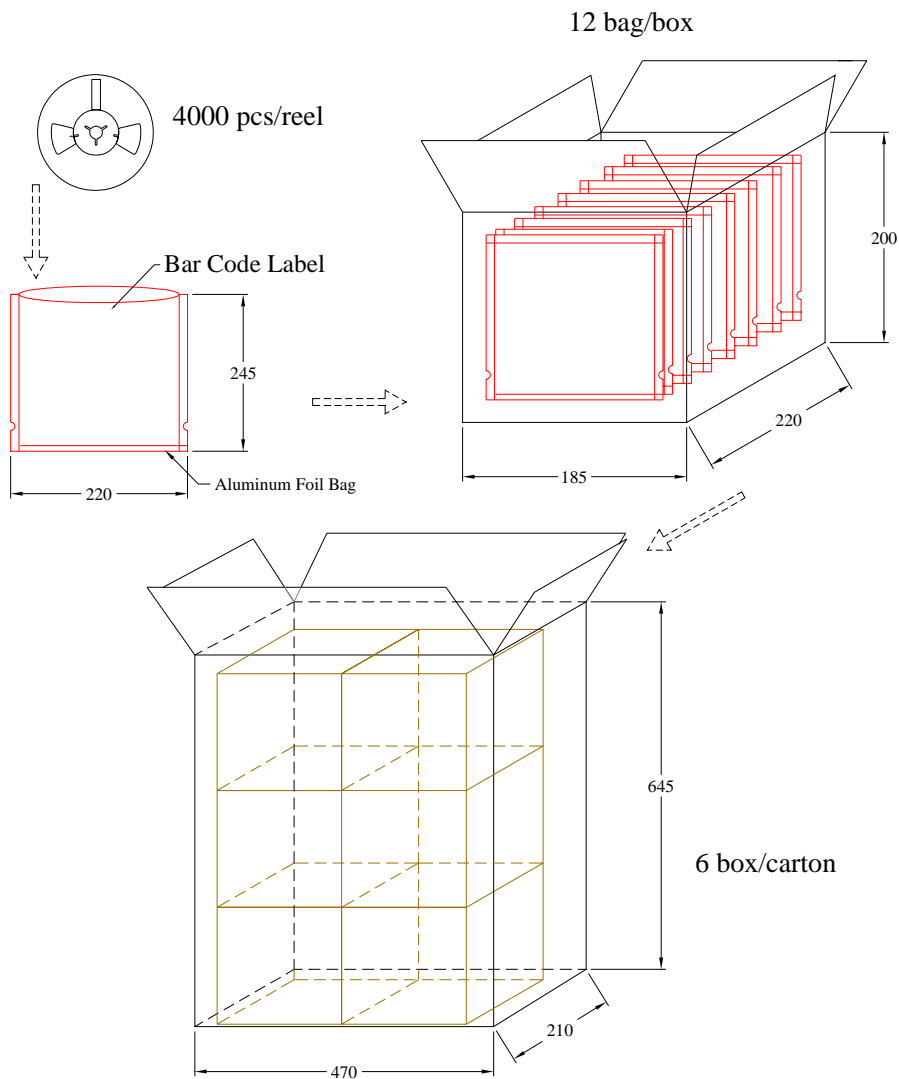



● Bin Limits

Intensity Bin Limits (At 20mA)

BIN CODE	Min. (mcd)	Max. (mcd)
T	317	475
U	475	715
V	715	1070
W	1070	1600

Tolerance for each Bin limit is $\pm 15\%$

V_F Bin Limits (At 20mA)

BIN CODE	Min.(v)	Max.(v)
G	2.8	3.0
H	3.0	3.2
J	3.2	3.4
K	3.4	3.6

Tolerance for each Bin limit is $\pm 0.05V$

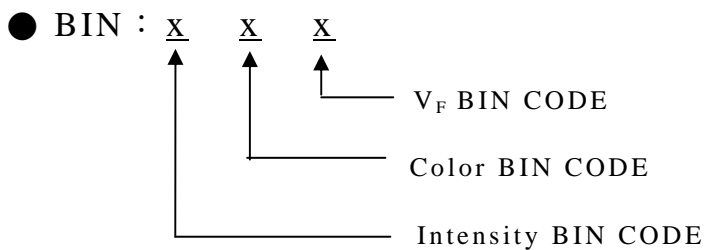



Color Bin Limits (At 20mA)

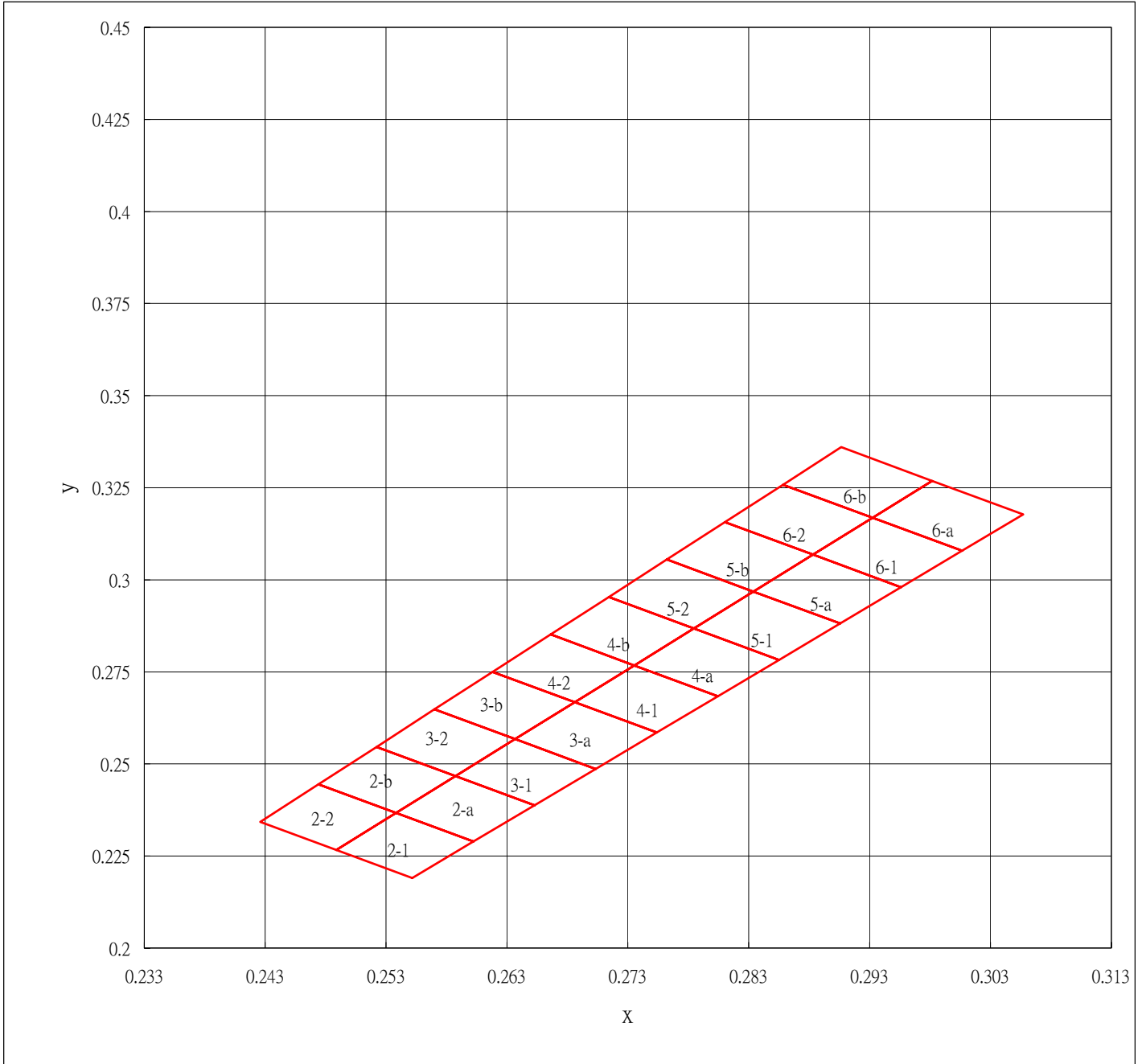



Color Bin Limits (At 20mA)

BIN	Chromaticity Coordinates				
2-1	x	0.25518	0.24889	0.25382	0.260232
	y	0.21904	0.22667	0.236691	0.228912
2-2	x	0.24889	0.2426	0.247407	0.25382
	y	0.22667	0.2343	0.244471	0.236691
2-a	x	0.260232	0.25382	0.258748	0.265285
	y	0.228912	0.236691	0.246713	0.238782
2-b	x	0.25382	0.247407	0.252211	0.258748
	y	0.236691	0.244471	0.254643	0.246713
3-1	x	0.265285	0.258748	0.263677	0.270339
	y	0.238782	0.246713	0.256734	0.248652
3-2	x	0.258748	0.252211	0.257015	0.263677
	y	0.246713	0.254643	0.264815	0.256734
3-a	x	0.270339	0.263677	0.268605	0.275392
	y	0.248652	0.256734	0.266755	0.258522
3-b	x	0.263677	0.257015	0.261819	0.268605
	y	0.256734	0.264815	0.274988	0.266755
4-1	x	0.275392	0.268605	0.273534	0.280445
	y	0.258522	0.266755	0.276776	0.268393
4-2	x	0.268605	0.261819	0.266623	0.273534
	y	0.266755	0.274988	0.28516	0.276776
4-a	x	0.280445	0.273534	0.278462	0.285498
	y	0.268393	0.276776	0.286797	0.278263
4-b	x	0.273534	0.266623	0.271427	0.278462
	y	0.276776	0.28516	0.295332	0.286797
5-1	x	0.285498	0.278462	0.283391	0.290551
	y	0.278263	0.286797	0.296819	0.288133
5-2	x	0.278462	0.271427	0.276231	0.283391
	y	0.286797	0.295332	0.305504	0.296819
5-a	x	0.290551	0.283391	0.288319	0.295604
	y	0.288133	0.296819	0.30684	0.298003
5-b	x	0.283391	0.276231	0.281035	0.288319
	y	0.296819	0.305504	0.315677	0.30684
6-1	x	0.295604	0.288319	0.293248	0.300657
	y	0.298003	0.30684	0.316861	0.307873
6-2	x	0.288319	0.281035	0.285839	0.293248
	y	0.30684	0.315677	0.325849	0.316861
6-a	x	0.300657	0.293248	0.298176	0.30571
	y	0.307873	0.316861	0.326882	0.317743
6-b	x	0.293248	0.285839	0.290643	0.298176
	y	0.316861	0.325849	0.336021	0.326882



● Reliability Test

Classification	Test Item	Reference Standard	Test Conditions	Result
Endurance Test	Operation Life	MIL-STD-750D:1026 MIL-STD-883D:1005 JIS-C-7021 :B-1	Ta: Under room temperature Test time:1,000hrs IF=Product Recommended IF	0/32
	High Temperature High Humidity Storage	MIL-STD-202F:103B JIS-C-7021 :B-11	Ta:85±5°C RH:90%-95% Test time:240hrs	0/32
	High Temperature Storage	MIL-STD-883:1008 JIS-C-7021 :B-10	Ta:100±5°C Test time:1,000hrs	0/32
	Low Temperature Storage	JIS-C-7021 :B-11	Ta: -40±5°C Test time=1,000hrs	0/32
Environmental Test	Temperature Cycling	MIL-STD-202F:107D MIL-STD-750D:1051 MIL-STD-883D:1010 JIS-C-7021 :A-2	Ta:-35±5°C~25±5°C~85±5°C~25±5°C 30min 5min 30min 5min	0/32
	Thermal Shock	MIL-STD-202F:107D(1980) MIL-STD-750D:1051(1995) MIL-STD-883D:1011(1991)	Ta:-40±5°C ~+85±5°C 10min 10 min Time: 20min/cycle 10cycle	0/32
	Wetting balance	MIL-STD-883:2003 MIL-STD-202F:208D MIL-STD-883D:2003	Ta:230±5°C Time:5±0.5s	0/32
	Solder Resistance	MIL-STD-202F:210A MIL-STD-883D:1011 JIS-C-7021 :A-1	Ta:260±10°C Time:10±1s	0/32

● Judgment criteria of failure for the reliability

Measuring items	Symbol	Measuring conditions	Judgement criteria for failure
Forward voltage	V_F (V)	$I_F=20mA$	Initial Level*1.1
Reverse current	$I_R(uA)$	$V_R=5V$	Over U*2
Luminous intensity	I_v (mcd)	$I_F=20mA$	Initial Level*0.7

Note: 1.U means the upper limit of specified characteristics.

2.Measurment shall be taken between 2 hours and after the test pieces have been returned to normal ambient conditions after completion of each test.

● IR-Reflow Soldering

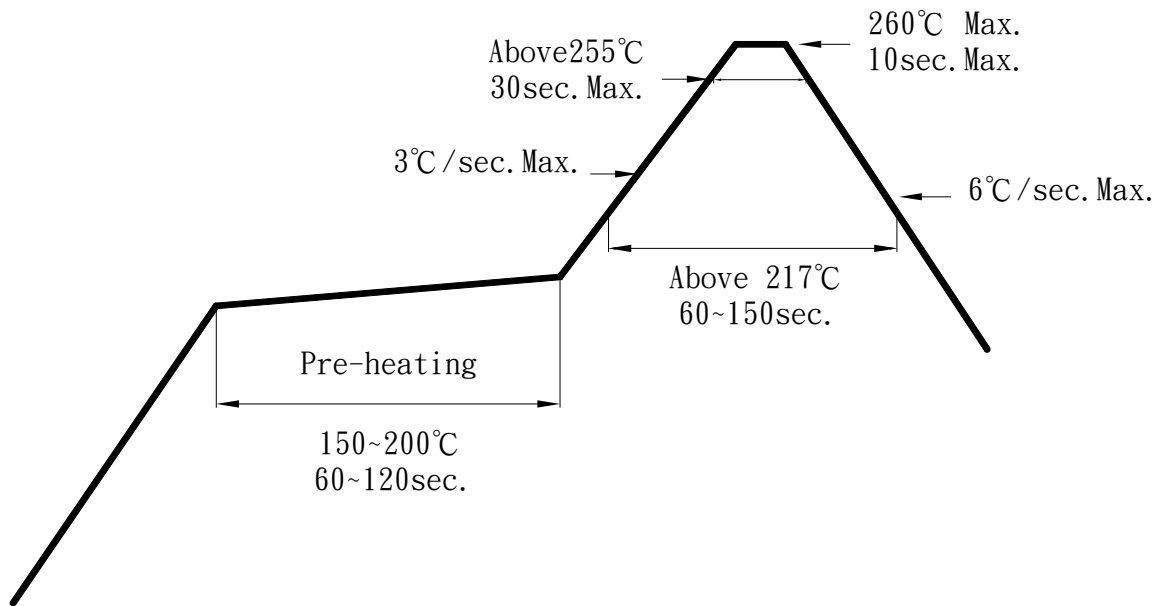

1. Avoid any external stress applied to the resin while the LEDs are at high temperature, especially during soldering .
2. Avoid rapid cooling or any excess vibration during temperature ramp-down process
3. Although the soldering condition is recommended above, soldering at the lowest possible temperature is feasible for the LEDs

● Dip Soldering

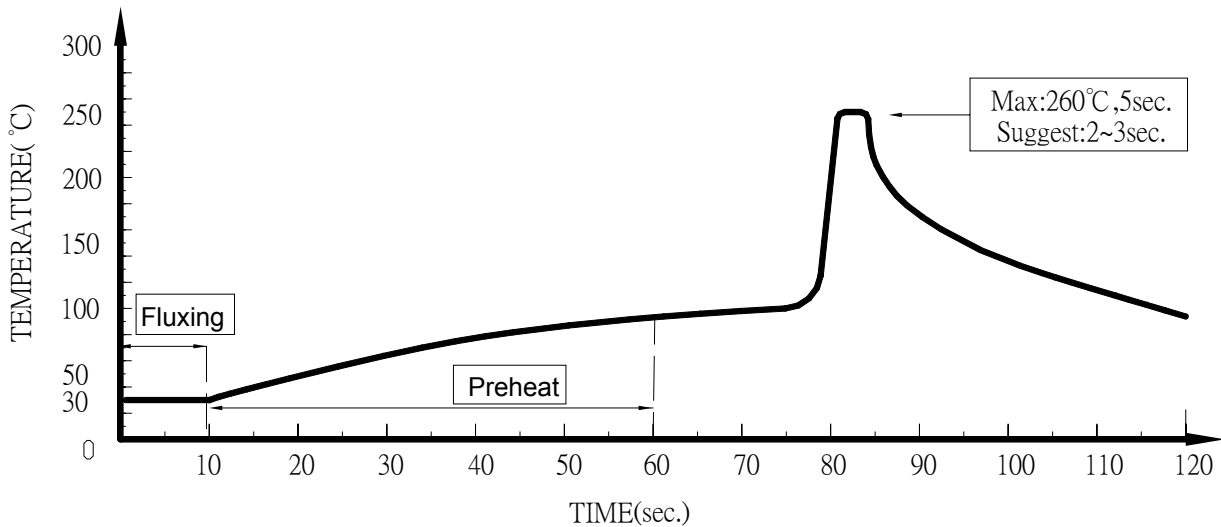

1. Please avoid any external stress applied to the lead-frames and epoxy while the LEDs are at high temperature, especially during soldering
2. DIP soldering and hand soldering should not be done more than one time.
3. After soldering, avoid the epoxy lens from mechanical shock or vibration until the LEDs are back to room temperature.
4. Avoid rapid cooling during temperature ramp-down process
5. Although the soldering condition is recommended above, soldering at the lowest possible temperature is feasible for the LEDs

● IRON Soldering

300°C Within 3 sec., One time only.



● Notes for designing:

Care must be taken to provide the current limiting resistor in the circuit so as to drive the BRIGHT LEDs within the rated figures. Also, caution should be taken not to overload BRIGHT LEDs with instantaneous voltage at the turning ON and OFF of the circuit.

When using the pulse drive care must be taken to keep the average current within the rated figures. Also, the circuit should be designed so as to be subjected to reverse voltage when turning off the BRIGHT LEDs.

● Storage:

In order to avoid the absorption of moisture, it is recommended to solder BRIGHT LEDs as soon as possible after unpacking the sealed envelope.

If the envelope is still packed, to store it in the environment as following:

- (1) Temperature : 5°C-30°C (41°F) Humidity : RH 60% Max.
- (2) After this bag is opened, devices that will be applied to infrared reflow, vapor-phase reflow, or equivalent soldering process must be:
 - a. Completed within 168 hours.
 - b. Stored at less than 30% RH.
- (3) Devices require baking before mounting, if:
 - (2) a or (2) b is not met.
- (4) If baking is required, devices must be baked under below conditions:
48 hours at 60°C±3°C.

● Package and Label of Products:

- (1) Package: Products are packed in one bag of 4000 pcs (one taping reel) and a label is attached on each bag.
- (2) Label:

