



Specification for Approval

- DEVICE NUMBER: BL-HZD39B-P
- CUSTOMER:

**SAMPLES
ATTACHED AREA**

DATE	PAGE										CONTENTS	
	1	2	3	4	5	6	7	8				
2011.03.01	1.0	1.0	1.0	1.0	1.0	1.0	1.0	1.0	1.0			Original Released
2017.01.19								1.1				Modify the welding conditions
2018/3/12		1.2		1.2								Modify IV

FOR CUSTOMER'S APPROVAL STAMP OR SIGNATURE

APPROVED	PURCHASE	MANUFACTURE	QUALITY	ENGINEERING

佰鴻工業股份有限公司
 BRIGHT LED ELECTRONICS CORP.
 新北市板橋區和平路 19 號 3 樓
 3F., No.19, He Ping Road,
 Ban Qiao Dist., New Taipei City,
 Taiwan
 Tel: +886-2-29591090
 Fax: +886-2-29547006/29558809
www.brtled.com

ISSUED	APPROVED	PREPARED
張孝嚴	張喜光	劉慧

● Features:

1. Emitted Color : Pure White
CCT: 5400-7000K
2. Lens Appearance: Yellow diffuse.
3. (4.0x0.8x1.4mm) standard package
4. Suitable for all SMT assembly methods.
5. Compatible with infrared and vapor phase reflow solder process.
6. Compatible with automatic placement equipment.
7. This product doesn't contain restriction Substance, comply ROHS standard.

● Applications:

1. Automotive : Dashboards, stop lamps, turn signals.
2. Backlighting : LCDs.
3. Status indicators : Consumer & industrial electronics.
4. General use.

● Package Dimensions:

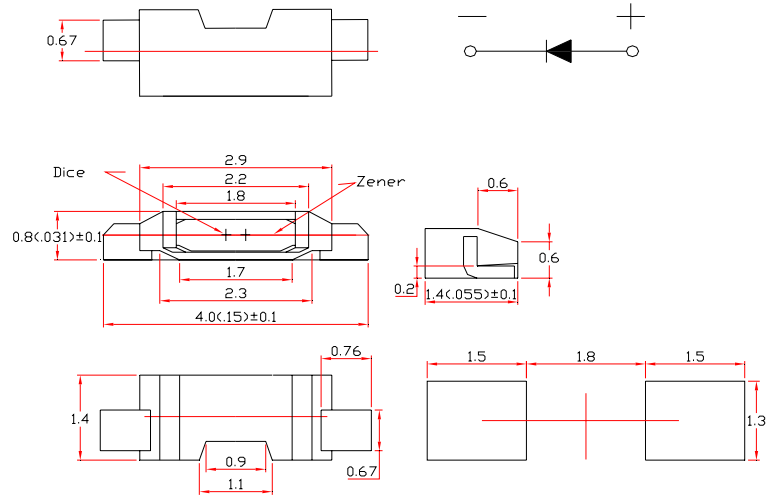

NOTES:

1. All dimensions are in millimeters (inches).
2. Tolerance is $\pm 0.10\text{mm}$ (0.004") unless otherwise specified.
3. Specifications are subject to change without notice.

● Absolute Maximum Ratings(Ta=25°C)

Parameter	Symbol	Rating	Unit
Power Dissipation	Pd	102	mW
Forward Current	I _F	30	mA
Peak Forward Current * 1	I _{FP}	100	mA
Operating Temperature	Topr	-40°C~85°C	°C-
Storage Temperature	Tstg	-40°C~85°C	-
Soldering Temperature	Tsol	See Page8	-

* 1 Condition for I_{FP} is pulse of 1/10 duty and 30 msec width.

● Electrical and optical characteristics(Ta=25°C)

Parameter	Symbol	Condition	Min.	Typ.	Max.	Unit
Forward Voltage	V _F	I _F =20mA	-	3.1	3.4	V
Luminous Intensity	I _v	I _F =20mA	2450	3000	-	mcd
Chromaticity Coordinates	x	I _F =20mA	-	0.32	-	-
	y	I _F =20mA	-	0.33	-	
Reverse Current	I _R	V _R =5V	-	-	10	μA
Viewing Angle	2θ _{1/2}	I _F =20mA	-	105	-	deg

● Typical Electro-Optical Characteristics Curves

Fig.1 Relative intensity vs. wavelength

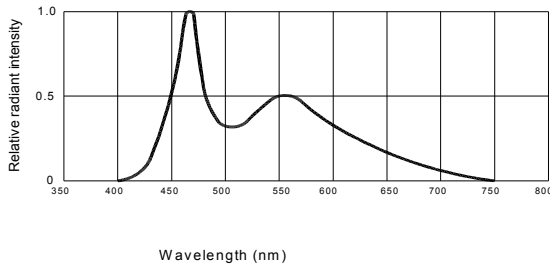

Fig.2 Forward current derating curve vs. ambient temperature

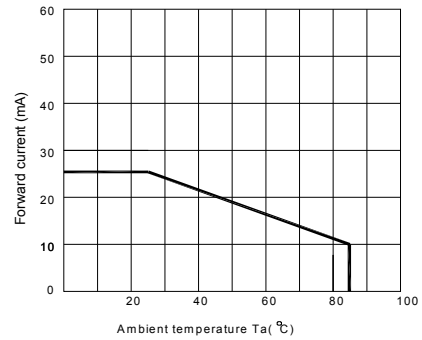

Fig.3 Forward current vs. forward voltage

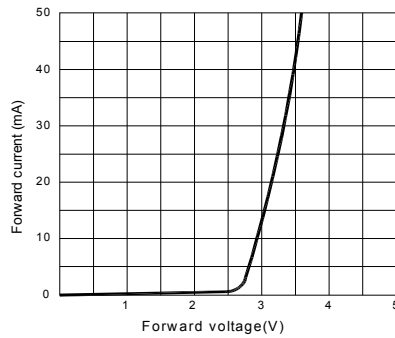

Fig.4 Relative luminous intensity vs. ambient temperature

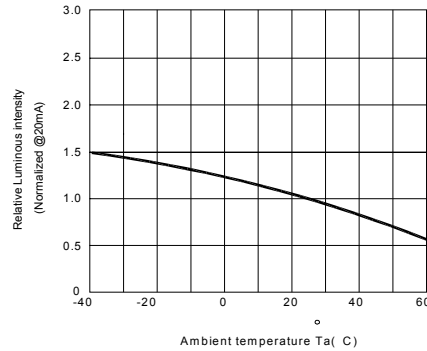

Fig.5 Relative luminous intensity vs. forward current

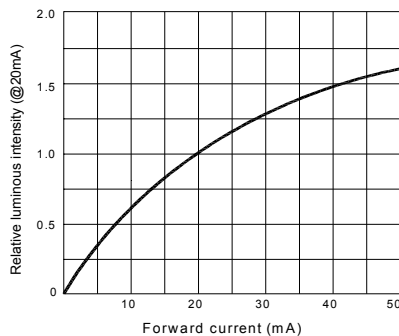
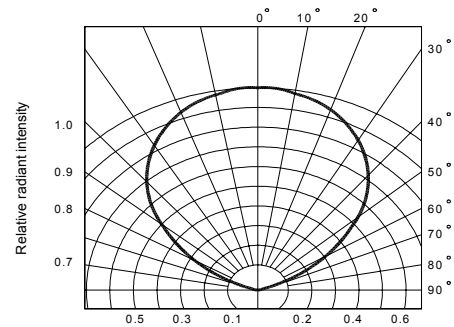
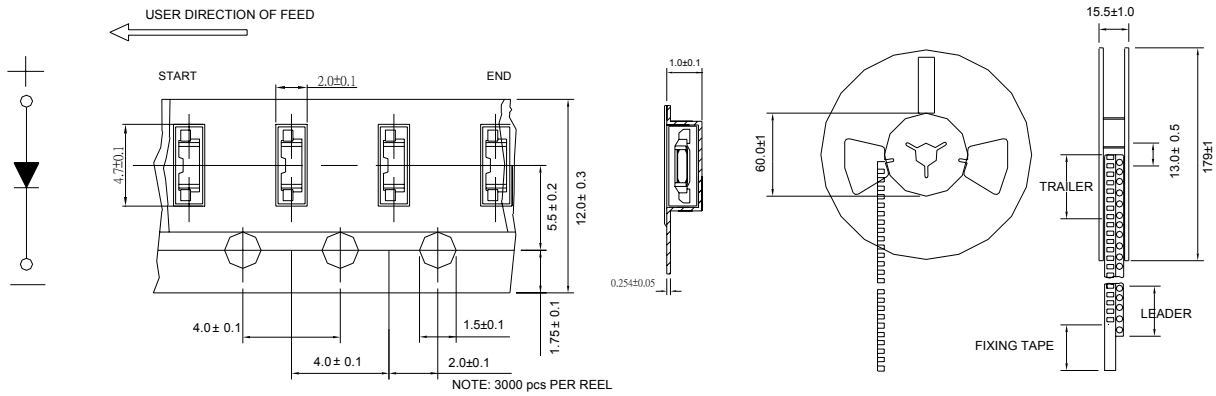

Fig.6 Radiation diagram



● Tapping and packaging specifications(Units: mm)



● Package Method:(unit:mm)

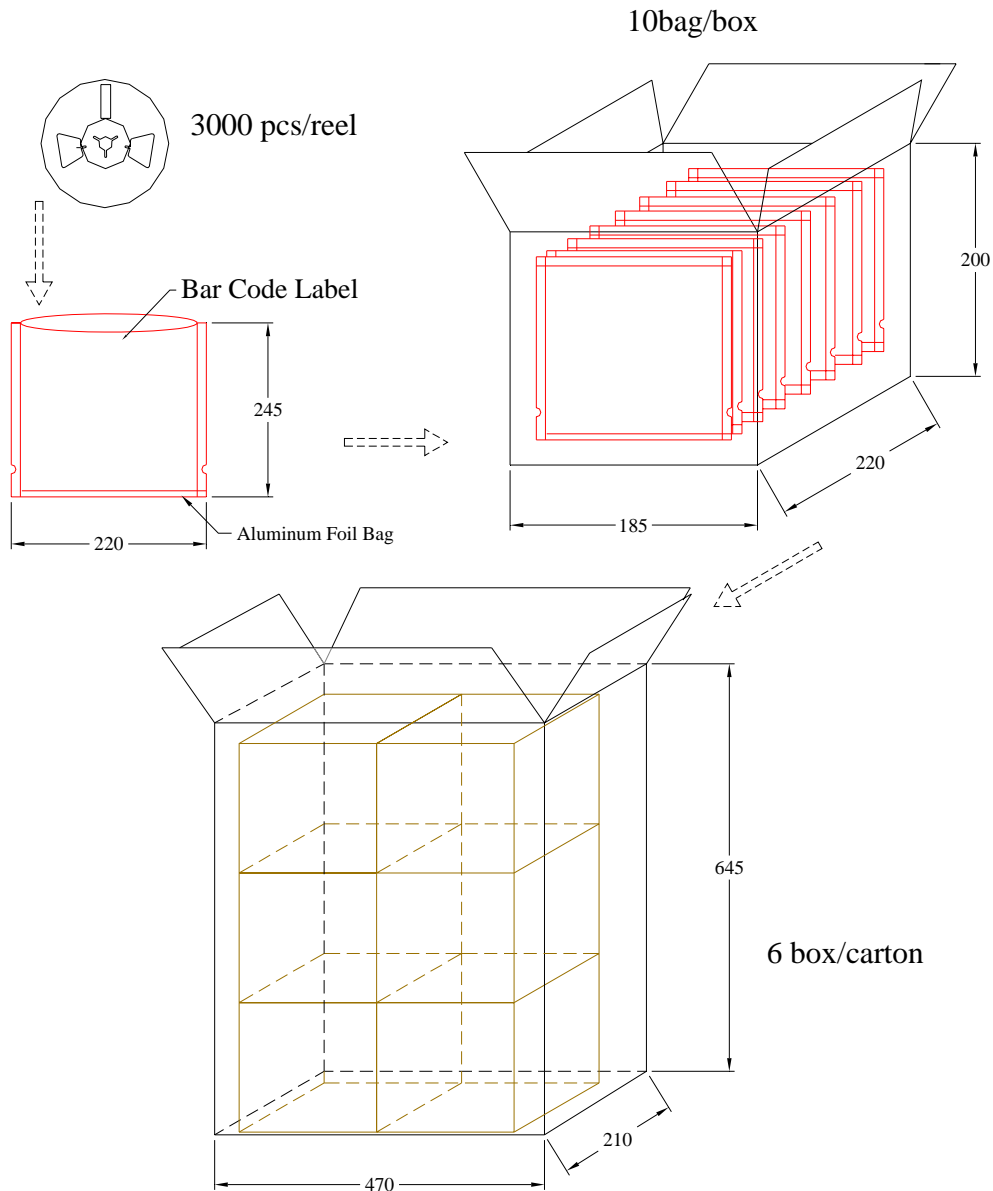

● **Bin Limits**

Intensity Bin Limits (At 20mA):

BIN CODE	Min. (mcd)	Max. (mcd)
Y1	2450	2600
Y2	2600	2750
Y3	2750	2900
Y4	2900	3050
Y5	3050	3200
Y6	3200	3350

VF Bin Limits (At 20mA):

BIN CODE	Min.(v)	Max.(v)
G1	2.8	2.9
G2	2.9	3.0
H1	3.0	3.1
H2	3.1	3.2
J1	3.2	3.3
J2	3.3	3.4

Color Bin Limits(At 20mA)

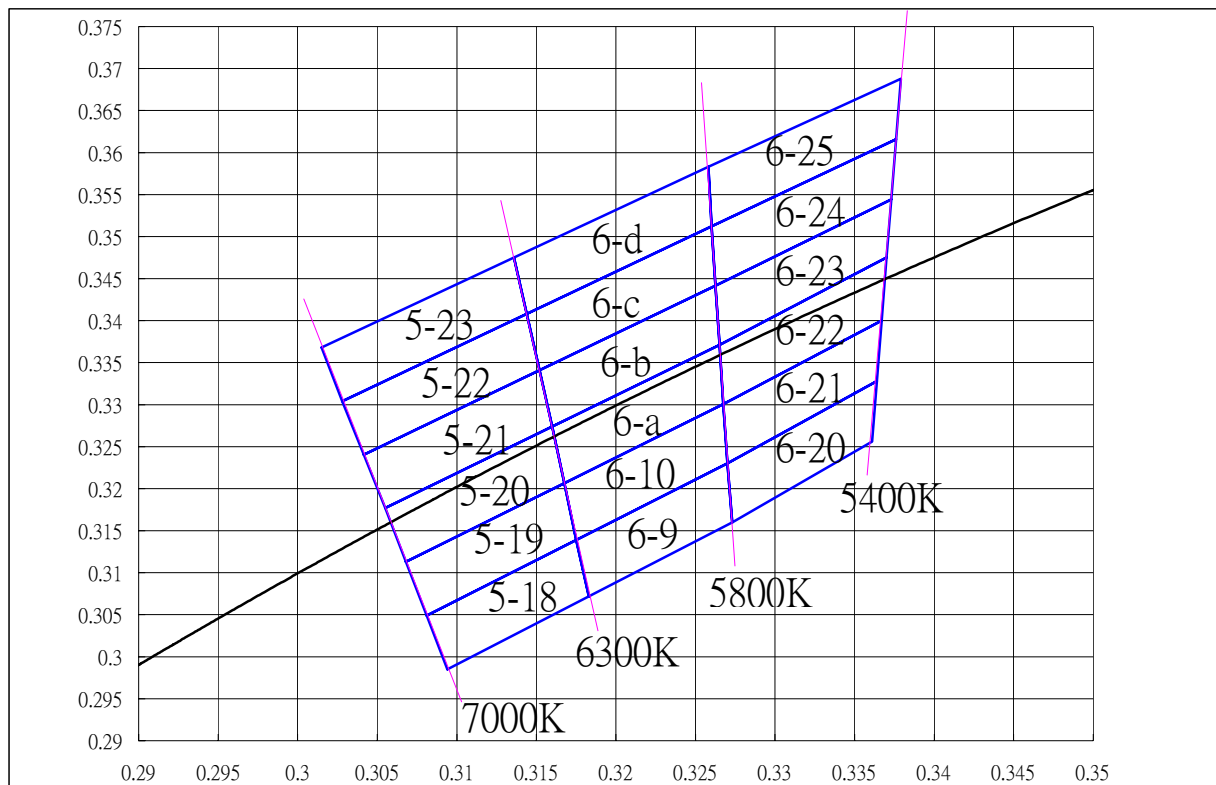

Color Bin Limits (At 20mA)

CCT	BIN	Chromaticity Coordinates					
		x	y	z	w		
6300-7000K	5-18	x	0.3094	0.3183	0.3175	0.3081	
		y	0.2985	0.3072	0.3139	0.3049	
	5-19	x	0.3081	0.3175	0.31675	0.3068	
		y	0.3049	0.3139	0.32065	0.3113	
	5-20	x	0.3068	0.31675	0.316	0.3055	
		y	0.3113	0.32065	0.3274	0.3177	
	5-21	x	0.3055	0.316	0.3152	0.30415	
		y	0.3177	0.3274	0.3341	0.32405	
	5-22	x	0.30415	0.3152	0.3144	0.3028	
		y	0.32405	0.3341	0.3408	0.3304	
	5-23	x	0.3015	0.3136	0.3144	0.3028	
		y	0.3368	0.3475	0.3408	0.3304	
	5800-6300K	6-9	x	0.3183	0.3273	0.327	0.3175
			y	0.3072	0.316	0.323	0.3139
6-10		x	0.3175	0.327	0.32675	0.31675	
		y	0.3139	0.323	0.33005	0.32065	
6-a		x	0.31675	0.32675	0.3265	0.316	
		y	0.32065	0.33005	0.3371	0.3274	
6-b		x	0.316	0.3265	0.32625	0.3152	
		y	0.3274	0.3371	0.34415	0.3341	
6-c		x	0.3152	0.32625	0.326	0.3144	
		y	0.3341	0.34415	0.3512	0.3408	
6-d		x	0.3136	0.3258	0.326	0.3144	
		y	0.3475	0.3583	0.3512	0.3408	
5400-5800K		6-20	x	0.3273	0.3361	0.3364	0.327
			y	0.316	0.3256	0.3328	0.323
	6-21	x	0.327	0.3364	0.3367	0.32675	
		y	0.323	0.3328	0.34	0.33005	
	6-22	x	0.32675	0.3367	0.337	0.3265	
		y	0.33005	0.34	0.3475	0.3371	
	6-23	x	0.3265	0.337	0.3373	0.32625	
		y	0.3371	0.3475	0.3544	0.34415	
	6-24	x	0.32625	0.3373	0.3376	0.326	
		y	0.34415	0.3544	0.3616	0.3512	
	6-25	x	0.326	0.3376	0.3379	0.3258	
		y	0.3512	0.3616	0.3688	0.3583	

CCT : Tolerance for each Bin limit is $\pm 100K$

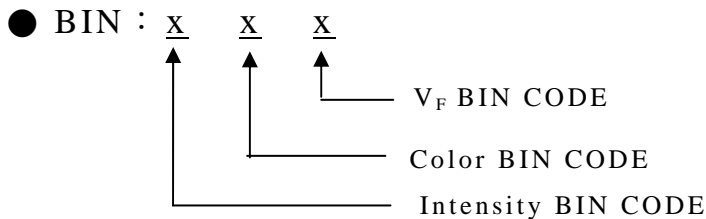

Notes:

1. I_v : Tolerance for each Bin limit is $\pm 10\%$
2. Color : Tolerance for each Bin limit is ± 0.005
3. Bin categories are established for classification of products.
Products may not be available in all bin categories.

● Reliability Test

Classification	Test Item	Reference Standard	Test Conditions	Result
Endurance Test	Operation Life	MIL-STD-750:1026 MIL-STD-883:1005 JIS-C-7021 :B-1	Connect with a power $I_f=20\text{mA}$ T_a =Under room temperature Test time=1,000hrs	0/20
	High Temperature High Humidity Storage	MIL-STD-202:103B JIS-C-7021 :B-11	$T_a=+65^\circ\text{C}\pm 5^\circ\text{C}$ RH=90%-95% Test time=240hrs	0/20
	High Temperature Storage	MIL-STD-883:1008 JIS-C-7021 :B-10	High $T_a=+85^\circ\text{C}\pm 5^\circ\text{C}$ Test time=1,000hrs	0/20
	Low Temperature Storage	JIS-C-7021 :B-12	Low $T_a=-35^\circ\text{C}\pm 5^\circ\text{C}$ Test time=1,000hrs	0/20
Environmental Test	Temperature Cycling	MIL-STD-202:107D MIL-STD-750:1051 MIL-STD-883:1010 JIS-C-7021 :A-4	$-35^\circ\text{C} \sim +25^\circ\text{C} \sim +85^\circ\text{C} \sim +25^\circ\text{C}$ 60min 20min 60min 20min Test Time=5cycle	0/20
	Thermal Shock	MIL-STD-202:107D MIL-STD-750:1051 MIL-STD-883:1011	$-35^\circ\text{C}\pm 5^\circ\text{C} \sim +85^\circ\text{C}\pm 5^\circ\text{C}$ 20min 20min Test Time=10cycle	0/20
	Solder Resistance	MIL-STD-202:201A MIL-STD-750:2031 JIS-C-7021 :A-1	Preheating : $140^\circ\text{C}-160^\circ\text{C}$, within 2 minutes. Operation heating : 260°C (Max.), within 10seconds. (Max.)	0/20

● Judgment criteria of failure for the reliability

Measuring items	Symbol	Measuring conditions	Judgement criteria for failure
Forward voltage	V_F (V)	$I_F=20\text{mA}$	Over $U_{x1.2}$
Reverse current	I_R (μA)	$V_R=5\text{V}$	Over U_{x2}
Luminous intensity	I_v (mcd)	$I_F=20\text{mA}$	Below $SX0.5$

Note: 1.U means the upper limit of specified characteristics. S means initial value.

2.Measurment shall be taken between 2 hours and after the test pieces have been returned to normal ambient conditions after completion of each test.

● IR-Reflow Soldering

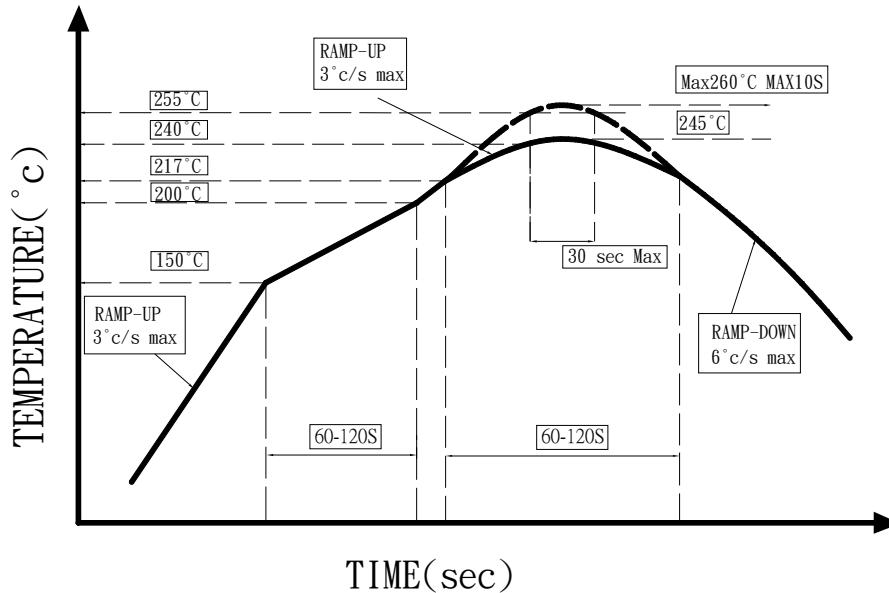

1. Avoid any external stress applied to the resin while the LEDs are at high temperature, especially during soldering .
2. Avoid rapid cooling or any excess vibration during temperature ramp-down process
3. Although the soldering condition is recommended above, soldering at the lowest possible temperature is feasible for the LEDs

● IRON Soldering

350°C Within 3 sec,one time only.

● Handling :

Care must be taken not to cause to the epoxy resin portion of BRIGHT LEDs while it is exposed to high temperature.

Care must be taken not rub the epoxy resin portion of BRIGHT LEDs with hard or sharp article such as the sand blast and the metal hook.

● **Notes for designing:**

Care must be taken to provide the current limiting resistor in the circuit so as to drive the BRIGHT LEDs within the rated figures. Also, caution should be taken not to overload BRIGHT LEDs with instantaneous voltage at the turning ON and OFF of the circuit.

When using the pulse drive care must be taken to keep the average current within the rated figures. Also, the circuit should be designed so as to be subjected to reverse voltage when turning off the BRIGHT LEDs.

● **Storage:**

In order to avoid the absorption of moisture, it is recommended to solder BRIGHT LEDs as soon as possible after unpacking the sealed envelope.

If the envelope is still packed, to store it in the environment as following:

- (1) Temperature : 5°C-30°C (41°F) Humidity : RH 60% Max.
- (2) After this bag is opened, devices that will be applied to infrared reflow, vapor-phase reflow, or equivalent soldering process must be:
 - a. Completed within 24 hours.
 - b. Stored at less than 20% RH.
- (3) Devices require baking before mounting, if:
 - (2) a or (2) b is not met.
- (4) If baking is required, devices must be baked under below conditions:
 - 48 hours at 60°C±5°C.

● **Package and Label of Products:**

- (1) Package: Products are packed in one bag of 3000 pcs (one taping reel) and a label is attached on each bag.
- (2) Label:
- (3)

