



BTA312A

TRIAC

12A TRIACS

DESCRIPTION

The UTC **BTA312A** is a 12A triacs which can be operated in 3 quadrants only, it uses UTC's advanced technology to provide customers with high commutation performances, etc.

The UTC **BTA312A** is suitable for inductive load switching operations, also can be used in ON/OFF function applications such as induction motor starting circuits, heating regulation, static relays etc.

SYMBOL

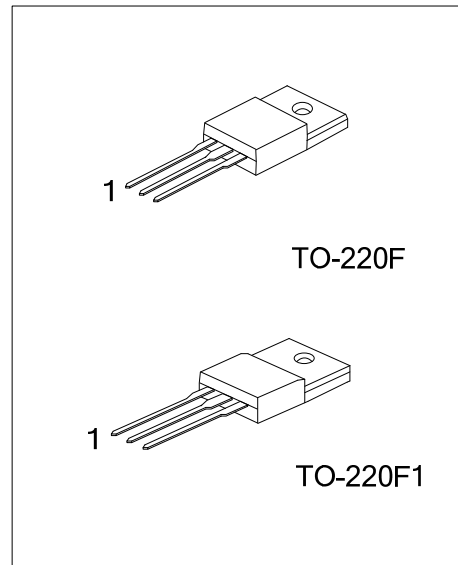
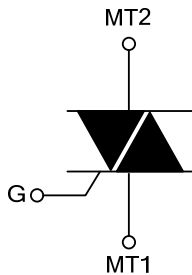

ORDERING INFORMATION

Ordering Number		Package	Pin Assignment			Packing
Lead Free	Halogen Free		1	2	3	
BTA312AL-x-xx-TF3-T	BTA312AG-x-xx-TF3-T	TO-220F	MT1	MT2	G	Tube
BTA312AL-x-xx-TF1-T	BTA312AG-x-xx-TF1-T	TO-220F1	MT1	MT2	G	Tube

Note: Pin Assignment: MT1: MT1 MT2: MT2 G: Gate

<p>BTA312AL-x-xx-TF3-T</p>	<p>(1) Packing Type (2) Package Type (3) Sensitivity and type (4) Voltage (5) Green Package</p>	<p>(1) T: Tube (2) TF3: TO-220F, TF1: TO-220F1 (3) refer to SENSITIVITY AND TYPE (4) 6: 600V, 8: 800V (5) L: Lead Free, G: Halogen Free and Lead Free</p>
----------------------------	---	---

SENSITIVITY AND TYPE

PART NUMBER	VOLTAGE		SENSITIVITY	TYPE
	600V	800V		
BW	⊙	⊙	50mA	SNUBBERLESS
CW	⊙	⊙	35mA	SNUBBERLESS
SW	⊙	⊙	10mA	LOGIC LEVEL
TW	⊙	⊙	5mA	LOGIC LEVEL

⊙: Available

MARKING

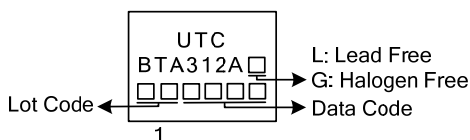

■ ABSOLUTE MAXIMUM RATINGS

PARAMETER			SYMBOL	RATINGS	UNIT
RMS On-State Current (Full Sine Wave)	$T_C=90^\circ\text{C}$		$I_{T(RMS)}$	12	A
Non Repetitive Surge Peak On-State Current (Full Cycle, T_J initial= 25°C)	F=50 Hz	t=20ms	I_{TSM}	120	A
	F=60 Hz	t=16.7ms		126	A
I^2t Value for Fusing	$t_p=10\text{ms}$		I^2t	78	A^2s
Critical Rate of Rise of On-State Current $I_G=2xI_{GT}$, $t_r \leq 100\text{ns}$	F=120 Hz	$T_J=125^\circ\text{C}$	dI/dt	50	$\text{A}/\mu\text{s}$
Non Repetitive Surge Peak Off-State Voltage	$t_p=10\text{ms}$	$T_J=25^\circ\text{C}$	V_{DSM}/V_{RSM}	$V_{DRM}/V_{RRM}+100$	V
Peak Gate Current	$t_p=20\mu\text{s}$	$T_J=125^\circ\text{C}$	I_{GM}	4	A
Average Gate Power Dissipation	$T_J=125^\circ\text{C}$		$P_{G(AV)}$	1	W
Operating Junction Temperature			T_J	-40 ~ +125	$^\circ\text{C}$
Storage Junction Temperature			T_{STG}	-40 ~ +150	$^\circ\text{C}$
Note:	Absolute maximum ratings are those values beyond which the device could be permanently damaged. Absolute maximum ratings are stress ratings only and functional device operation is not implied.				

■ THERMAL RESISTANCES

PARAMETER	SYMBOL	RATINGS	UNIT
Junction to Ambient	θ_{JA}	60	$^\circ\text{C}/\text{W}$
Junction to Case (AC)	θ_{JC}	2.3	$^\circ\text{C}/\text{W}$

■ ELECTRICAL CHARACTERISTICS ($T_J=25^\circ\text{C}$ unless otherwise specified)

FOR SNUBBERLESS TYPE and LOGIC LEVEL TYPE (3 QUADRANTS)

PARAMETER	SYMBOL	TEST CONDITIONS	TW			SW			CW			BW			UNIT
			MIN	TYP	MAX	MIN	TYP	MAX	MIN	TYP	MAX	MIN	TYP	MAX	
Gate Trigger Current (Note 1)	I_{GT}	$V_D=12\text{V}$, $R_L=30\Omega$	I-II-III		5			10			35			50	mA
Gate Trigger Voltage	V_{GT}		I-II-III		1.3			1.3			1.3			1.3	V
Gate Non-Trigger Voltage	V_{GD}	$V_D=V_{DRM}$, $R_L=3.3\text{k}\Omega$, $T_J=125^\circ\text{C}$	I-II-III	0.2		0.2			0.2			0.2			V
Holding Current (Note 2)	I_H	$I_T=100\text{mA}$			10			15			35			50	mA
Latching Current	I_L	$I_G=1.2I_{GT}$	I-III		10			25			50			70	mA
			II		15			30			60			80	mA
Critical Rate of Rise of Off-State Voltage (Note 2)	dV/dt	$V_D=67\%V_{DRM}$, Gate Open, $T_J=125^\circ\text{C}$		20		40			500			1000			$\text{V}/\mu\text{s}$
Critical Rate of Rise of Off-State Voltage at Commutation (Note 2)	(dI/dt)c	(dV/dt)c=0.1V/ μs , $T_J=125^\circ\text{C}$		3.5		6.5									A/ms
		(dV/dt)c=10V/ μs , $T_J=125^\circ\text{C}$		1		2.9									
		Without Snubber $T_J=125^\circ\text{C}$							6.5			12			

Note: 1. Minimum I_{GT} is guaranteed at 5% of I_{GT} max.
2. For both polarities of MT2 referenced to MT1.

■ STATIC CHARACTERISTICS

PARAMETER	SYMBOL	TEST CONDITIONS		MIN	TYP	MAX	UNIT
Peak On-State Voltage(Note)	V_T	$I_{TM}=17A, t_p=380\mu s$	$T_J=25^\circ C$			1.55	V
Threshold Voltage(Note)	V_{TO}		$T_J=125^\circ C$			0.85	V
Dynamic Resistance(Note)	R_D		$T_J=125^\circ C$			35	m Ω
Repetitive Peak Off-State Current	I_{DRM}	$V_{DRM}=V_{RRM}$	$T_J=25^\circ C$			5	μA
	I_{RRM}		$T_J=125^\circ C$			1	mA

Note: 1. Minimum I_{GT} is guaranteed at 5% of I_{GT} max.
 2. For both polarities of MT2 referenced to MT1.

■ TYPICAL CHARACTERISTICS

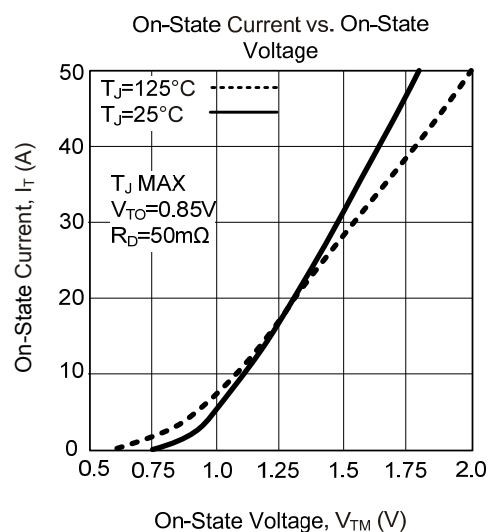
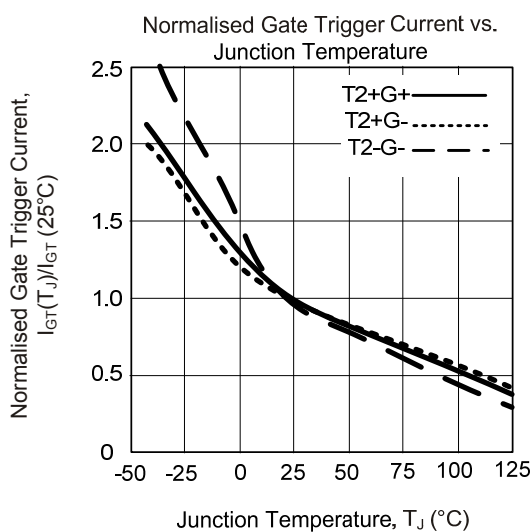
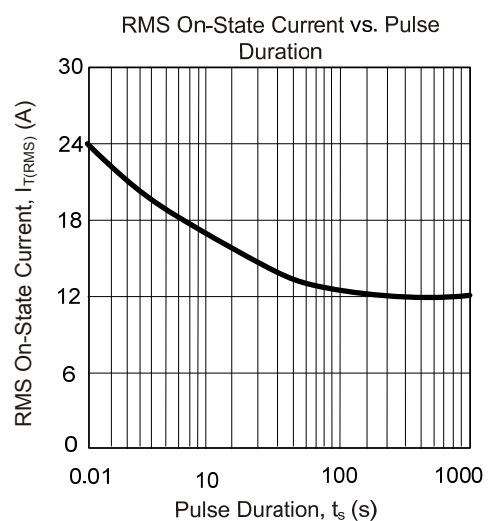
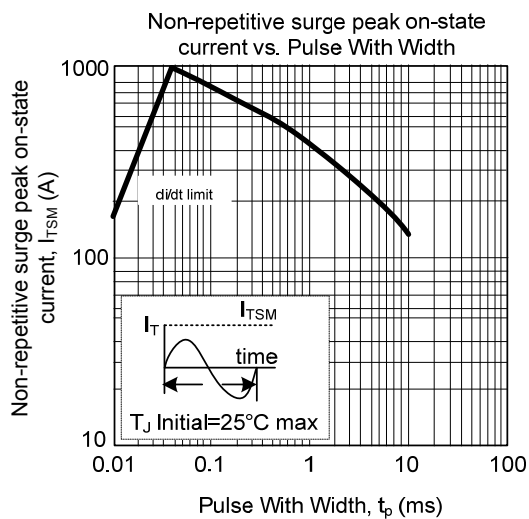
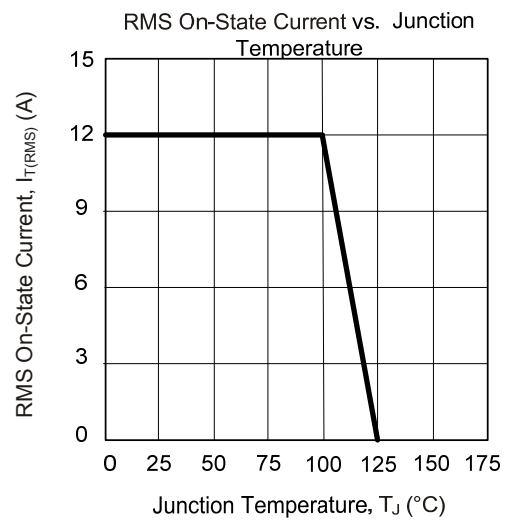
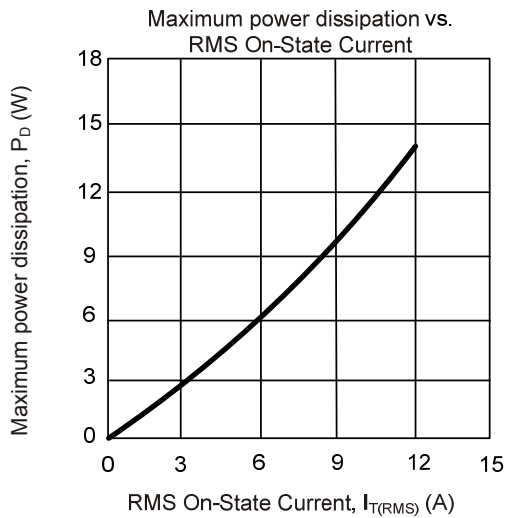

■ TYPICAL CHARACTERISTICS (Cont.)

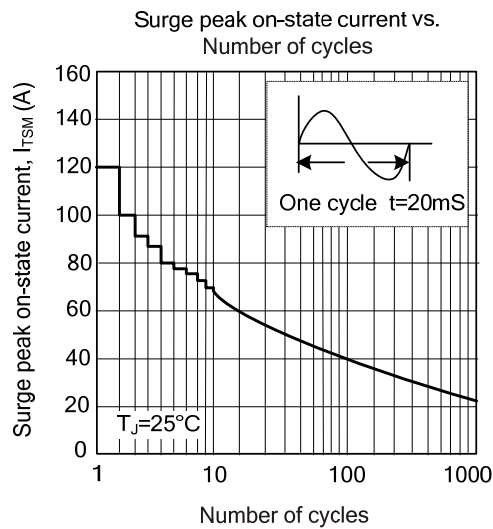

UTC assumes no responsibility for equipment failures that result from using products at values that exceed, even momentarily, rated values (such as maximum ratings, operating condition ranges, or other parameters) listed in products specifications of any and all UTC products described or contained herein. UTC products are not designed for use in life support appliances, devices or systems where malfunction of these products can be reasonably expected to result in personal injury. Reproduction in whole or in part is prohibited without the prior written consent of the copyright owner. The information presented in this document does not form part of any quotation or contract, is believed to be accurate and reliable and may be changed without notice.