



LM4880

CMOS IC

DUAL 250mW AUDIO POWER AMPLIFIER WITH SHUTDOWN MODE

DESCRIPTION

The UTC **LM4880** is a dual audio power amplifier capable of delivering typically 250mW per channel of continuous average power to an 8Ω load with 0.1% THD+N using a 5V power supply.

The UTC **LM4880** features an externally controlled, low-power consumption shutdown mode, as well as an internal thermal shutdown protection mechanism.

The unity-gain stable UTC **LM4880** can be configured by external gain-setting resistors.

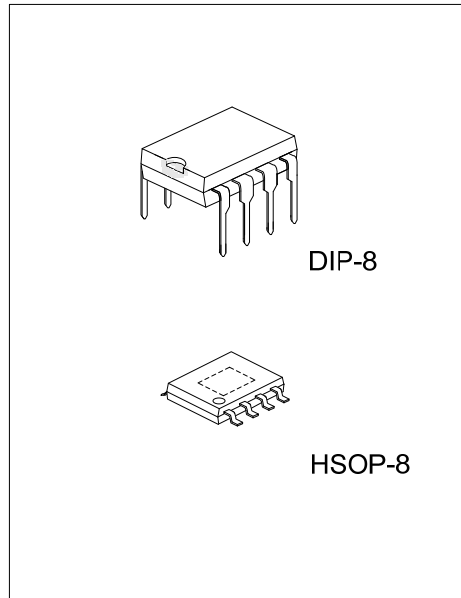

FEATURES

- * No bootstrap capacitors or snubber circuits are necessary
- * Unity-gain stable
- * External gain configuration capability

APPLICATIONS

- * Personal Computers
- * CD-ROM Players
- * Headphone Amplifier

ORDERING INFORMATION

Ordering Number		Package	Packing
Lead Free	Halogen Free		
LM4880L-D08-T	LM4880G-D08-T	DIP-8	Tube
-	LM4880G-SH2-R	HSOP-8	Tape Reel

<p>LM4880L-D08-T</p> <ul style="list-style-type: none"> (1) Packing Type (2) Package Type (3) Green Package 	<ul style="list-style-type: none"> (1) T: Tube, R: Tape Reel (2) D08: DIP-8, SH2: HSOP-8 (3) L: Lead Free, G: Halogen Free and Lead Free
--	---

MARKING

DIP-8	HSOP-8

■ PIN CONFIGURATION

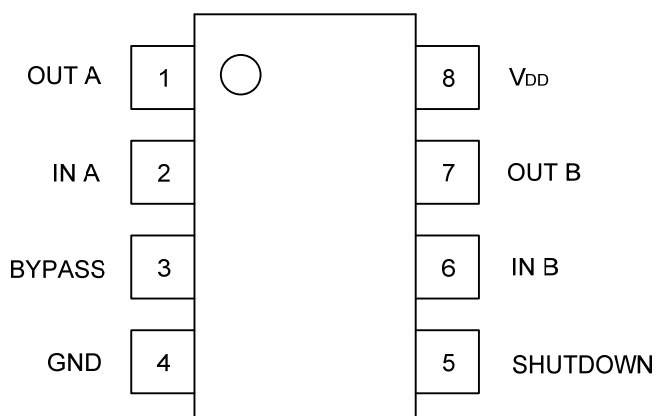

■ PIN DESCRIPTION

PIN NO	PIN NAME	I/O	DESCRIPTION
1	OUT A	O	Channel A output
2	IN A	I	Channel A audio input
3	BYPASS	I	Connect to internal voltage divider for middle supply bias
4	GND		Ground
5	SHUTDOWN	I	Shutdown mode control input, high active, place LM4880 into shutdown mode, when held high
6	IN B	I	Channel B audio input
7	OUT B	O	Channel B output
8	V _{DD}		Supply voltage

■ ABSOLUTE MAXIMUM RATINGS (Note 1)

PARAMETER	SYMBOL	RATINGS	UNIT
Supply Voltage	V_{DD}	6.0	V
Input Voltage	V_{IN}	-0.3 ~ $V_{DD}+0.3$	V
ESD Susceptibility (Note 2)	ESD	3500	V
ESD Susceptibility (Note 3)		250	V
Power Dissipation (Note 4)	P_D	Internally limited	
Junction Temperature	T_J	150	°C
Operating Temperature	T_{OPR}	-40 ~ +85	°C
Storage Temperature	T_{STG}	-65 ~ +150	°C

Notes: 1. Absolute Maximum Ratings indicate limits beyond which damage may occur. Operating ratings indicate conditions for which the device is functional, but do not guarantee specific performance limits. Electrical Characteristics state DC and AC electrical specifications under particular test conditions which guarantee specific performance limits. This assumes that the device is within the operating ratings. Specifications are not guaranteed for parameters where no limit is given, however, the typical value is a good indication of device performance.

- Human body model, 100 pF discharged through a 1.5 kΩ resistor.
- Machine model, 200 pF discharged through all pins.
- The maximum power dissipation must be derated at elevated temperatures and is dictated by T_{JMAX} , θ_{JA} , and the ambient temperature T_A . The maximum allowable power dissipation is $P_{DMAX} = (T_{JMAX} - T_A) / \theta_{JA}$ or the number given in the Absolute Maximum Ratings, whichever is lower.

■ THERMAL DATA

PARAMETER	SYMBOL	RATINGS	UNIT
Junction to Ambient	DIP-8	107	°C/W
	HSOP-8	42.3	
Junction to Case	DIP-8	37	°C/W
	HSOP-8	12	

■ OPERATING RATINGS

PARAMETER	SYMBOL	RATINGS	UNIT
Supply Voltage	V_{DD}	2.7 ~ 5.5	V
Temperature Range ($T_{MIN} \leq T_A \leq T_{MAX}$)	T_A	-40 ~ +85	°C

■ ELECTRICAL CHARACTERISTICS ($T_A=25^\circ\text{C}$, $V_{DD}=5\text{V}$, $f=1\text{kHz}$ unless otherwise specified)

PARAMETER	SYMBOL	TEST CONDITIONS	MIN	TYP	MAX	UNIT
Supply Voltage	V_{DD}		2.7		5.5	V
Quiescent Power Supply Current	I_{DD}	$V_{IN}=0\text{V}$, $I_{OUT}=0\text{A}$		3.6	6.0	mA
Shutdown Current	I_{SHDN}	$V_{PIN5}=V_{DD}$		0.7	5	μA
Output Offset Voltage	$V_{O(OFF)}$	$V_{IN}=0\text{V}$		5	50	mV
Output Power	P_{OUT}	THD=0.1%(MAX), $f=1\text{KHz}$	$R_L=8\Omega$	200	250	mW
			$R_L=32\Omega$		85	mW
		THD+N=10%, $f=1\text{KHz}$	$R_L=8\Omega$		325	mW
			$R_L=32\Omega$		110	mW
Total Harmonic Distortion + Noise	THD+N	$R_L=8\Omega$, $P_{OUT}=200\text{mW}$, $f=1\text{KHz}$		0.03		%
		$R_L=32\Omega$, $P_{OUT}=75\text{mW}$, $f=1\text{KHz}$		0.02		%
Power Supply Rejection Ratio	PSRR	$C_B=1.0\mu\text{F}$, $V_{RIPPLE}=200\text{mV}_{RMS}$, $f=100\text{Hz}$		50		dB

Note: All voltages are measured with respect to the ground pin, unless otherwise specified.

■ TYPICAL APPLICATION

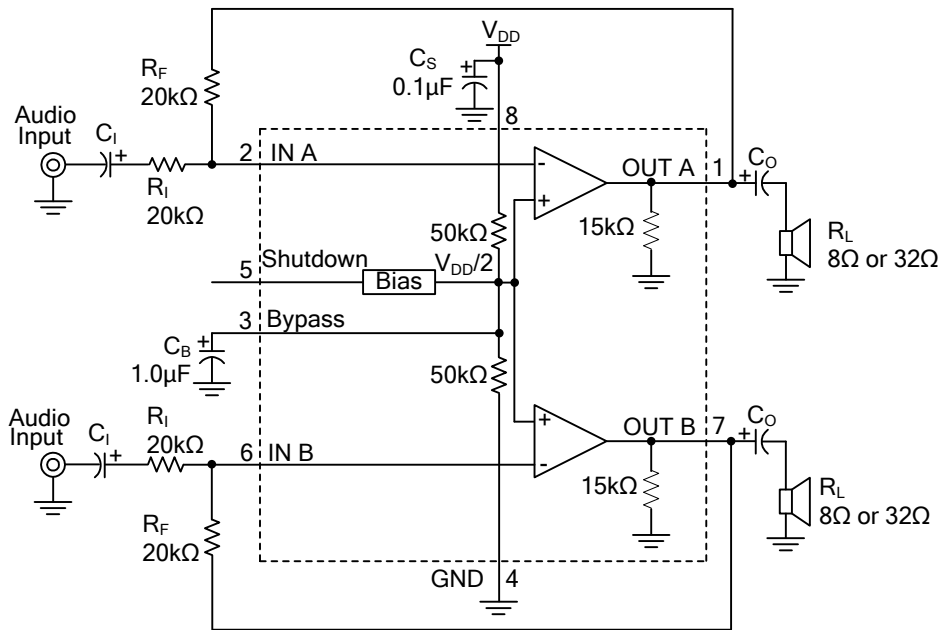

Fig. 1 Typical Audio Amplifier Application Circuit

■ EXTERNAL COMPONENTS DESCRIPTION (Fig. 1)

COMPONENTS	FUNCTIONAL DESCRIPTION	
1.	R_i	Inverting input resistance which sets the closed-loop gain in conjunction with R_F . This resistor also forms a high pass filter with C_i at $f_c = 1/(2\pi R_i C_i)$.
2.	C_i	Input coupling capacitor which blocks the DC voltage at the amplifier's input terminals. Also creates a high pass filter with R_i at $f_c = 1/(2\pi R_i C_i)$.
3.	R_F	Feedback resistance which sets closed-loop gain in conjunction with R_i .
4.	C_s	Supply bypass capacitor which provides power supply filtering.
5.	C_B	Bypass pin capacitor which provides half-supply filtering.
6.	C_o	Output coupling capacitor which blocks the DC voltage at the amplifier's output. Forms a high pass filter with R_L at $f_o = 1/(2\pi R_L C_o)$.



■ AUTOMATIC SHUTDOWN CIRCUIT

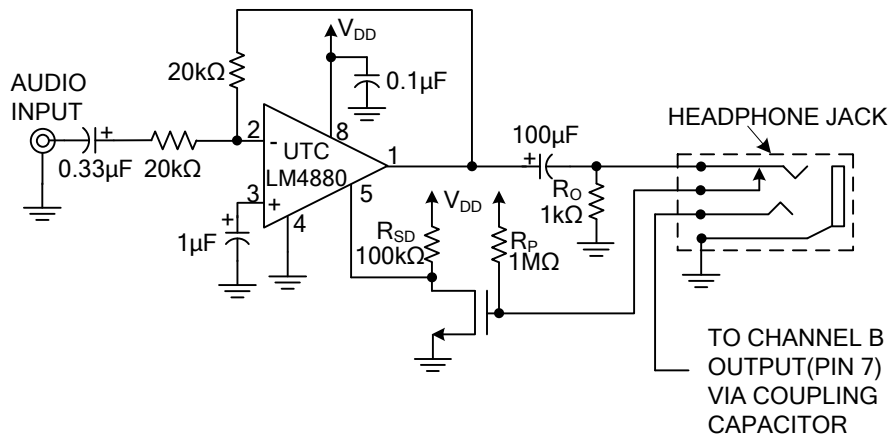

Fig. 2 Automatic Shutdown Circuit

■ AUTOMATIC SWITCHING CIRCUIT

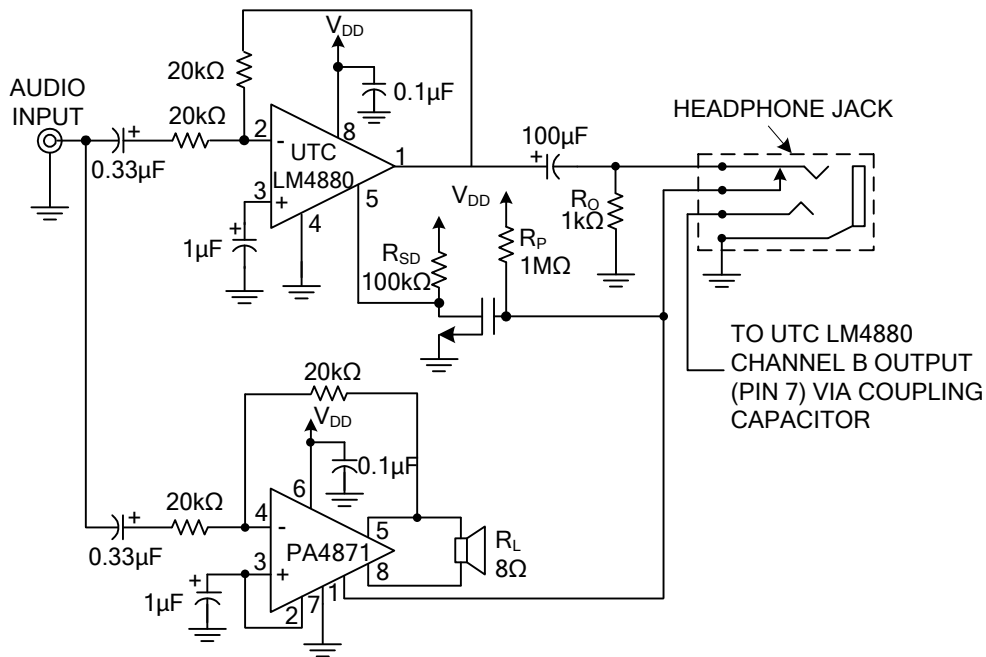
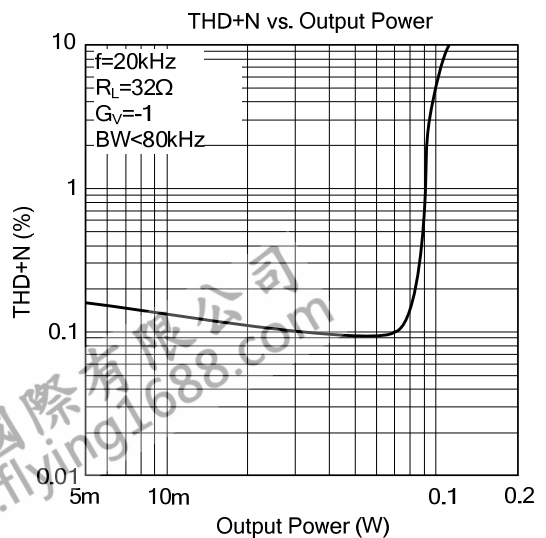
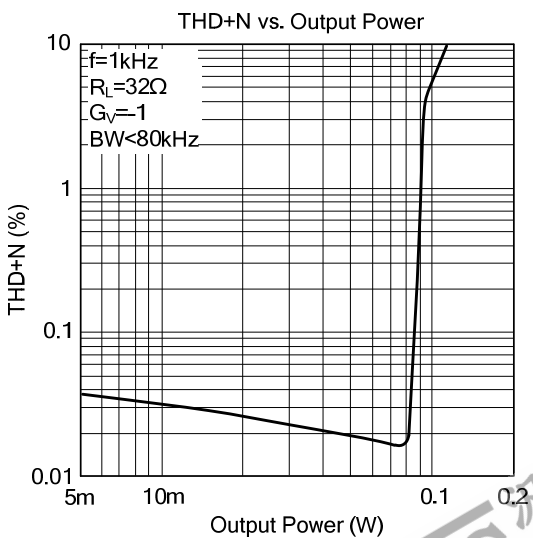
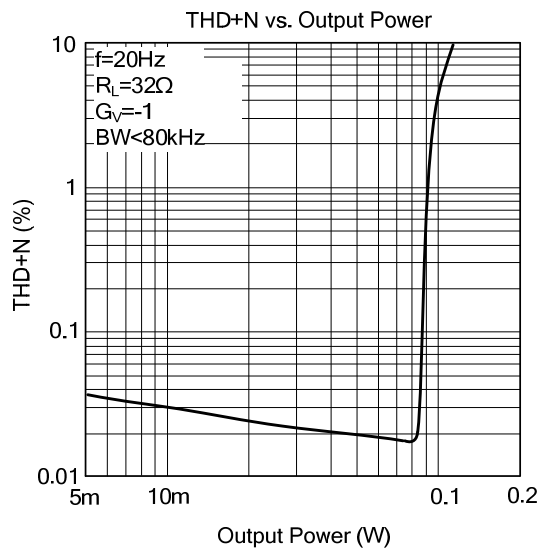
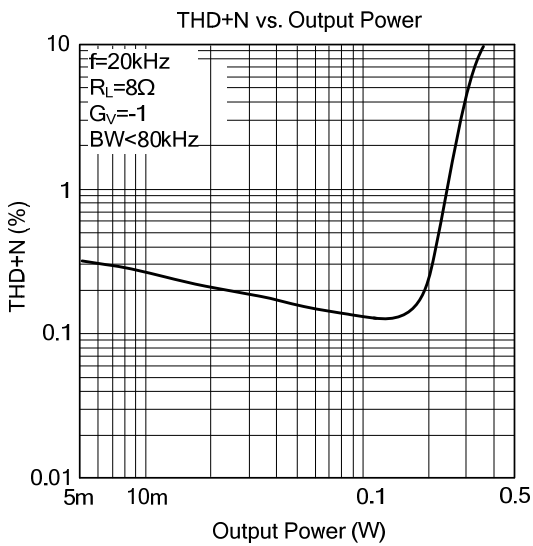
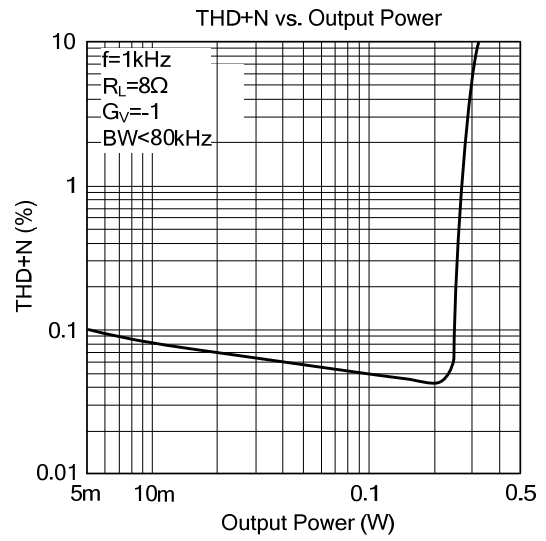
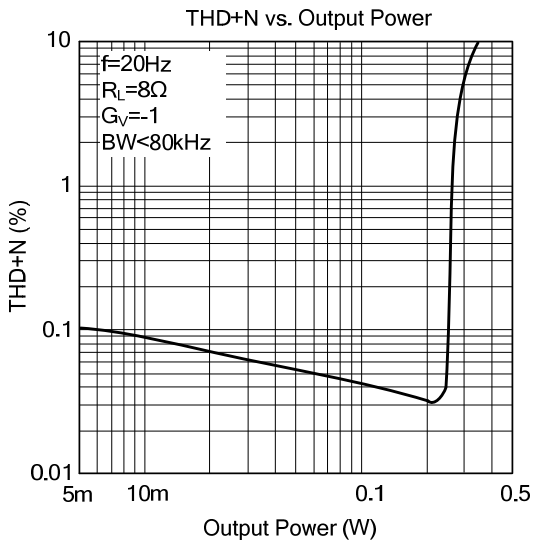
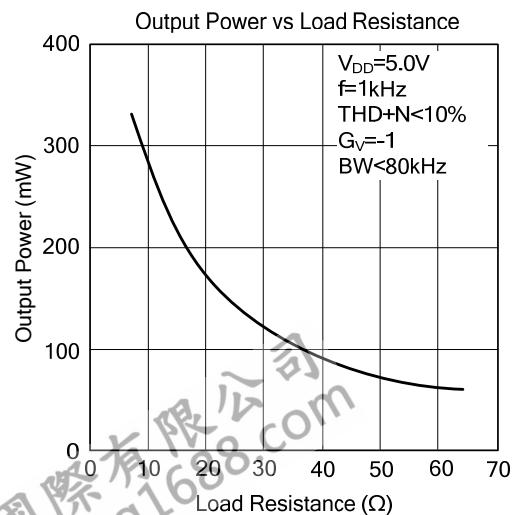
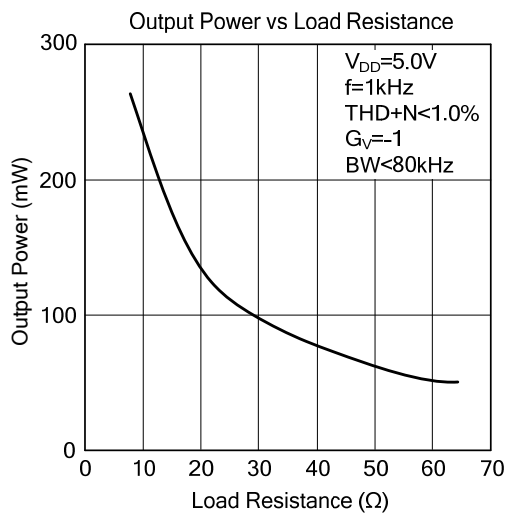
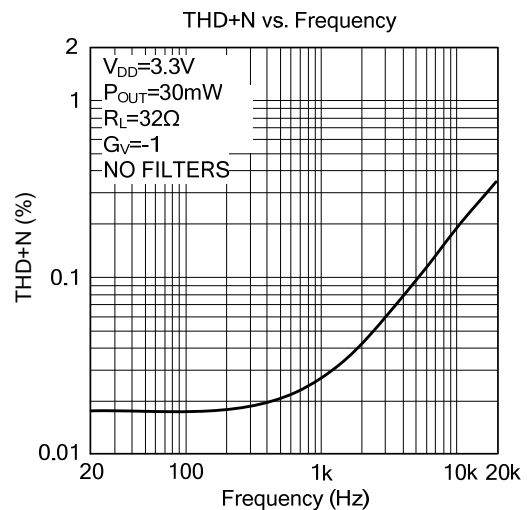
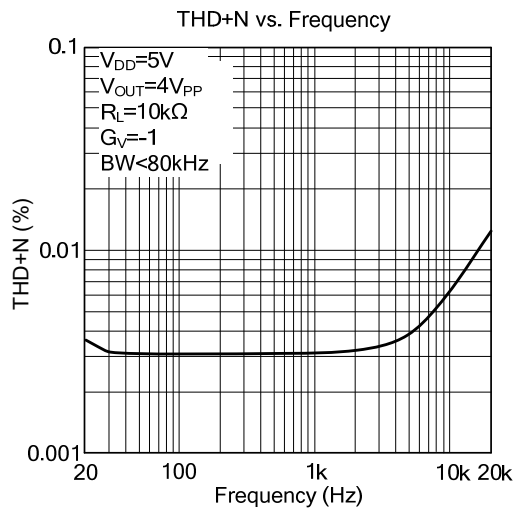
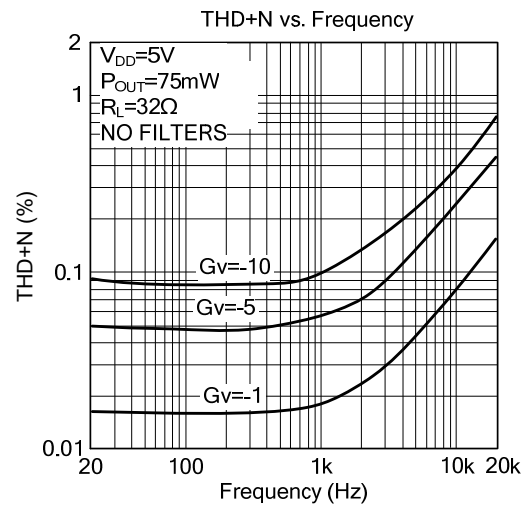
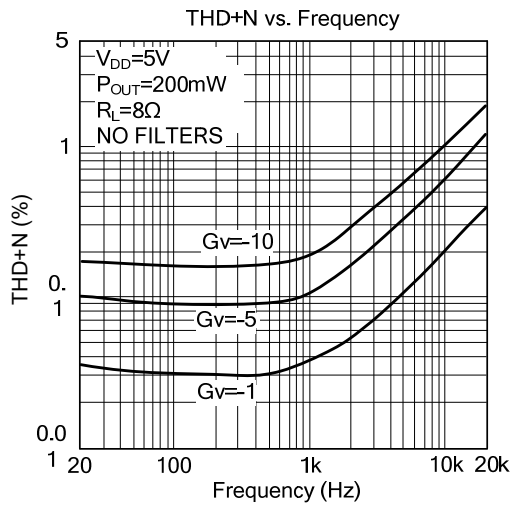

Fig. 3 Automatic Switching Circuit

■ TYPICAL CHARACTERISTICS



TYPICAL CHARACTERISTICS(Cont.)



■ TYPICAL CHARACTERISTICS(Cont.)

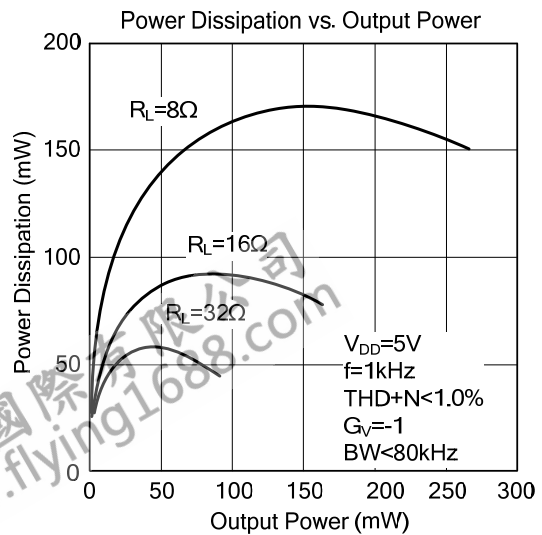
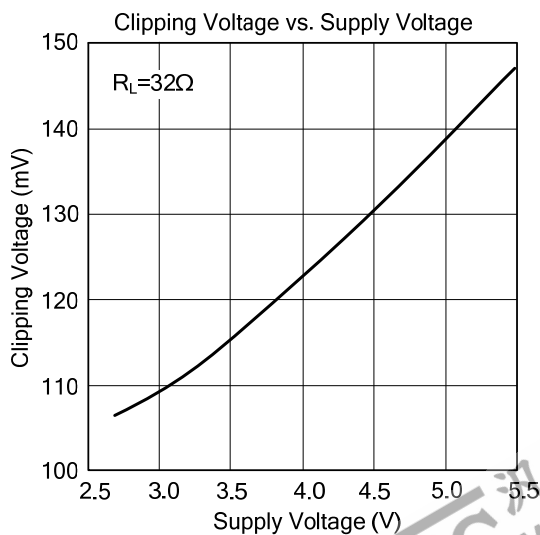
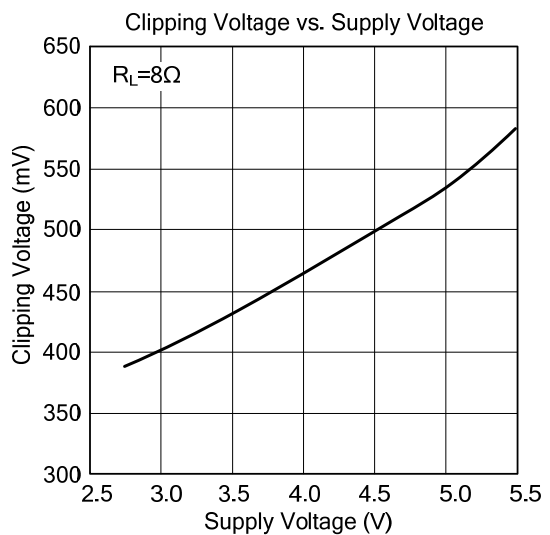
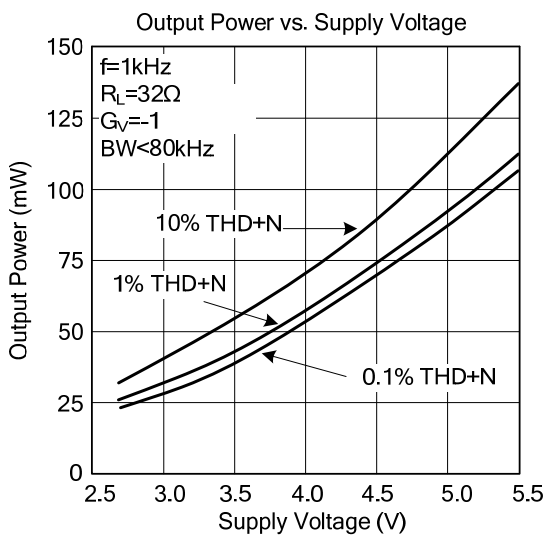
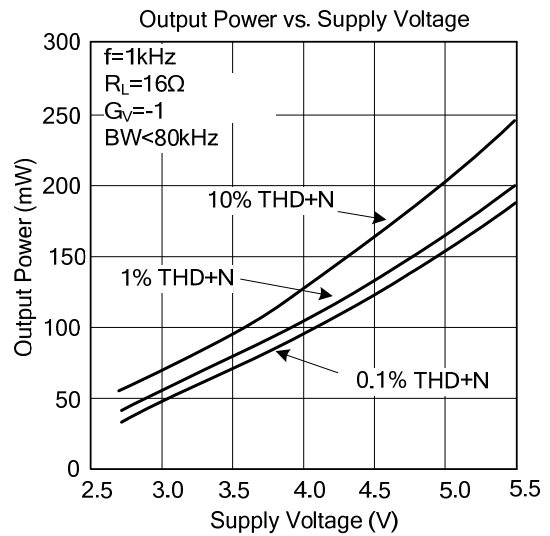
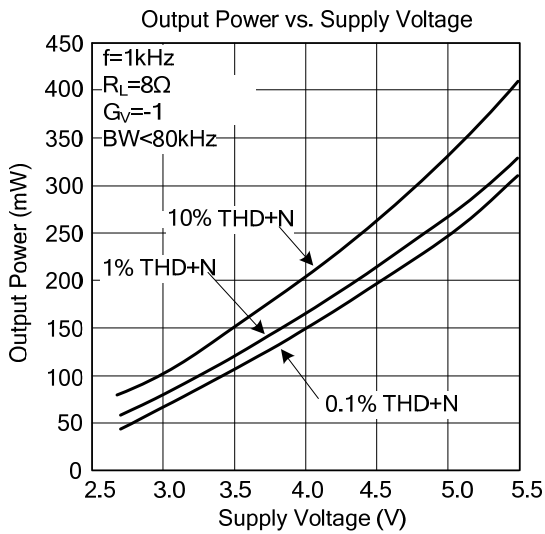

TYPICAL CHARACTERISTICS(Cont.)

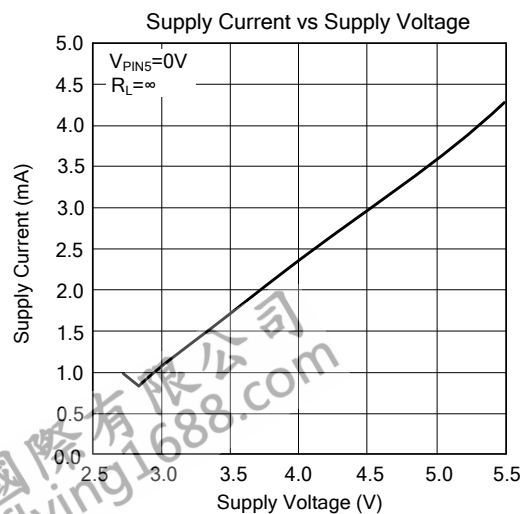
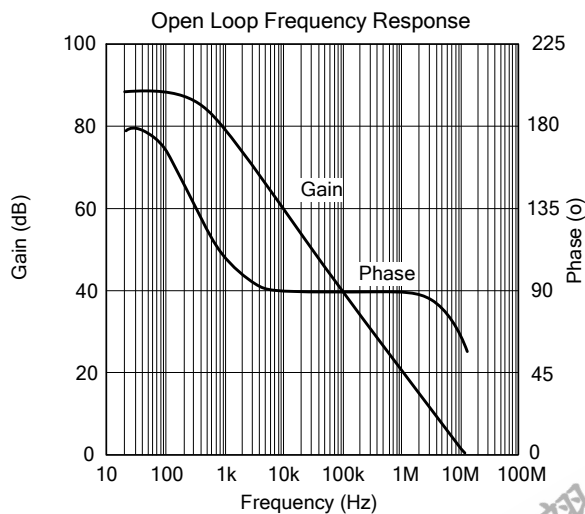
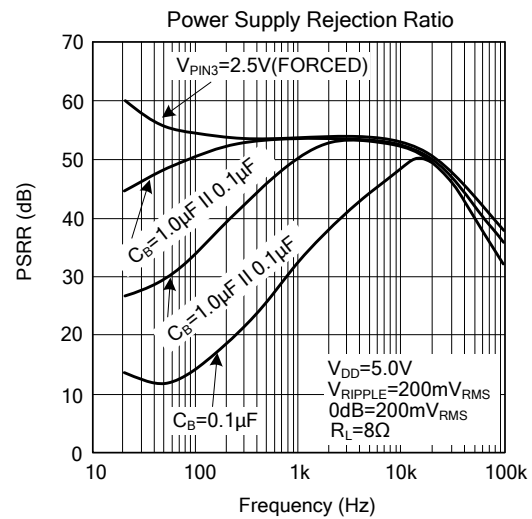
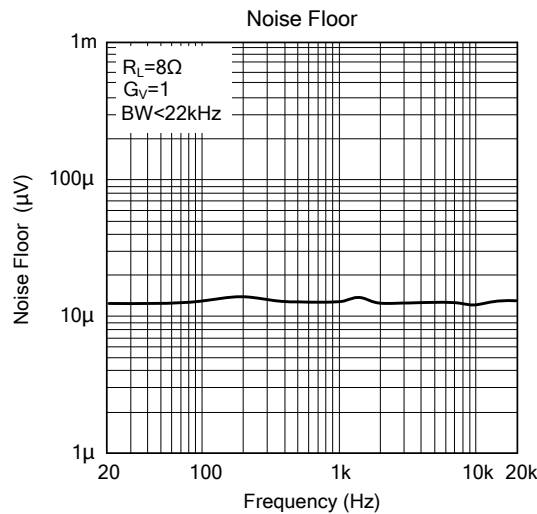
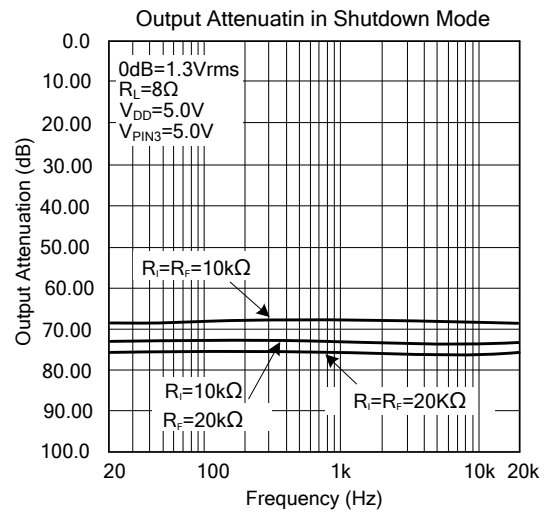
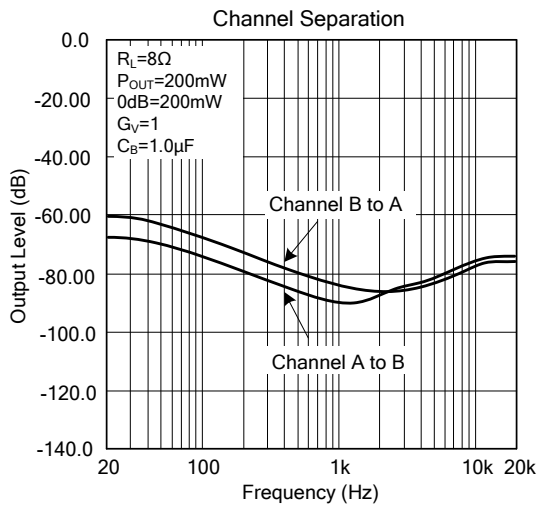

TYPICAL CHARACTERISTICS(Cont.)

Frequency Response vs. Output Capacitor Size

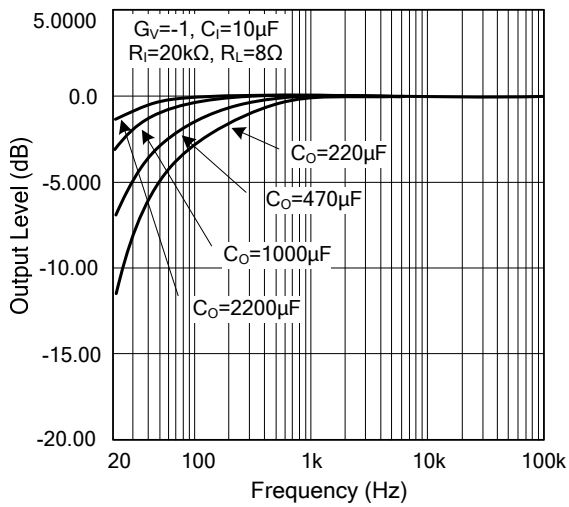

Frequency Response vs. Output Capacitor Size

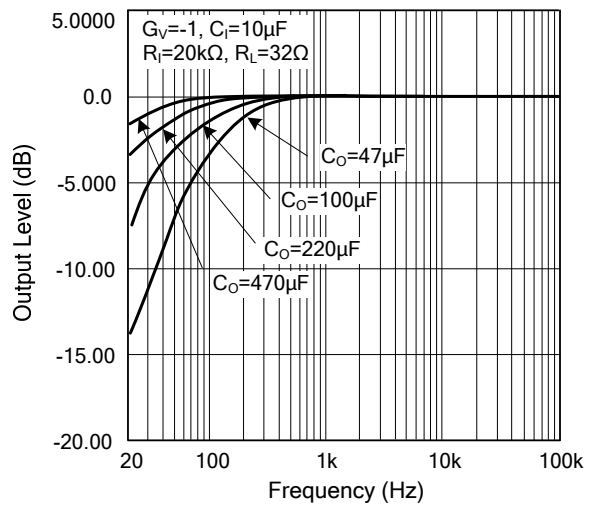

Frequency Response vs Input Capacitor Size

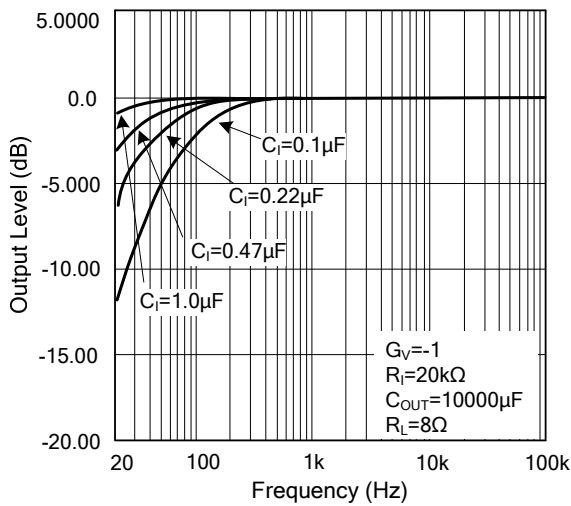

Typical Application Frequency Response

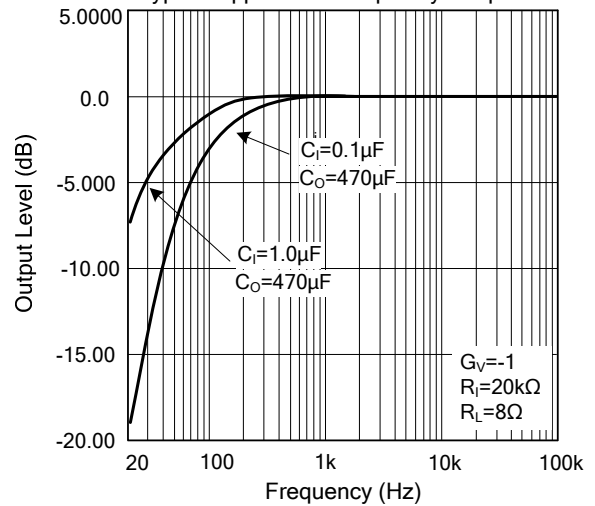

Typical Application Frequency Response

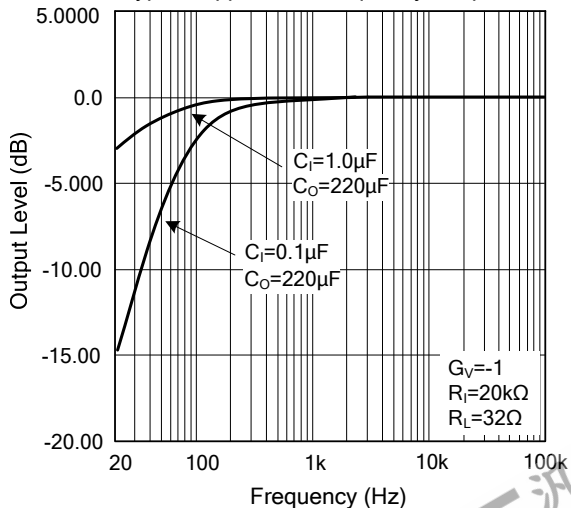

UTC assumes no responsibility for equipment failures that result from using products at values that exceed, even momentarily, rated values (such as maximum ratings, operating condition ranges, or other parameters) listed in products specifications of any and all UTC products described or contained herein. UTC products are not designed for use in life support appliances, devices or systems where malfunction of these products can be reasonably expected to result in personal injury. Reproduction in whole or in part is prohibited without the prior written consent of the copyright owner. The information presented in this document does not form part of any quotation or contract, is believed to be accurate and reliable and may be changed without notice.