



# LV321

## LINEAR INTEGRATED CIRCUIT

### SINGLE GENERAL PURPOSE, LOW VOLTAGE, RAIL-TO-RAIL OUTPUT OPERATIONAL AMPLIFIER

■ DESCRIPTION

The UTC **LV321** is a single op amp with low supply current. It brings good performance in low voltage, low power operating systems. The UTC **LV321** has a guaranteed 0.8V/μs slew rate and a 1MHz unity-gain bandwidth, in low supply current. It provides heavy rail-to-rail (R-to-R) output swing loads and the input common-mode voltage range including ground. Besides, it is also capable for comfortably driving large capacitive loads.

The UTC **LV321** has bipolar input and CMOS output for improved noise performance and higher output current drive. It's the most cost effective solution for the applications where low voltage operation, space saving and low price are required.

■ FEATURES

- \* 2.7V and 5V Performance Guaranteed
- \* No Crossover Distortion
- \* 130μA Low Supply Current
- \* Rail-to-Rail Output Swing @10kΩ Load: V<sup>+</sup> -25mV  
V<sup>-</sup> +15mV
- \* V<sub>CM</sub> From -0.2V to V<sup>+</sup> -0.8V

■ ORDERING INFORMATION

Ordering Number		Package	Packing
Lead Free	Halogen Free		
LV321L-AF5-R	LV321G-AF5-R	SOT-25	Tape Reel
LV321L-AF5-A-R	LV321G-AF5-A-R	SOT-25	Tape Reel
LV321L-AL5-R	LV321G-AL5-R	SOT-353	Tape Reel

<p>LV321G-AF5-A-R</p> <p>(1)Packing Type (2)Packing Type (3)Package Type (4)Green Package</p>	<p>(1) R: Tape Reel (2) refer to Pin Assignment (3) AF5: SOT-25, AL5: SOT-353 (4)G: Halogen Free and Lead Free, L: Lead Free</p>
---	--

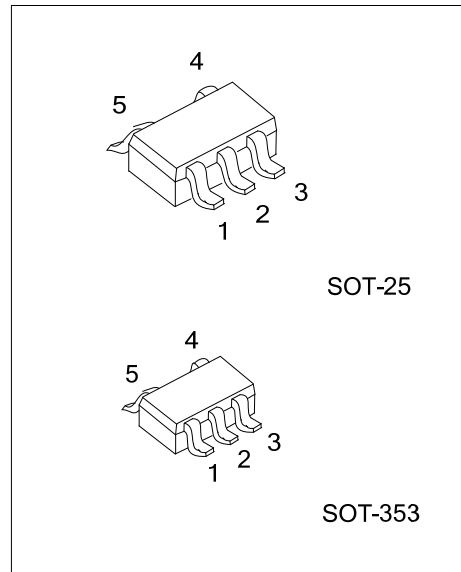

### MARKING

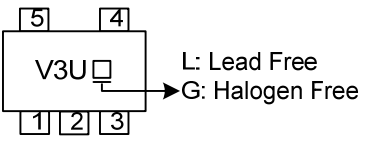
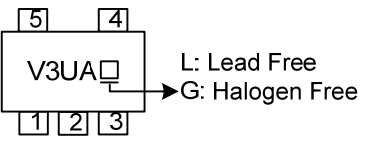
LV321	LV321-A
 <p>L: Lead Free G: Halogen Free</p>	 <p>L: Lead Free G: Halogen Free</p>

### PIN CONFIGURATION

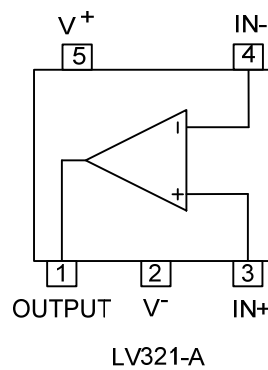
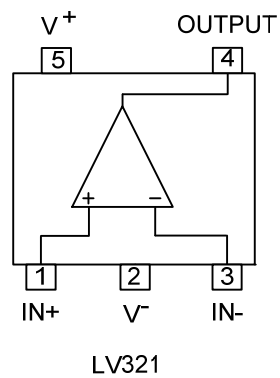

### ■ ABSOLUTE MAXIMUM RATINGS

PARAMETER	SYMBOL	RATINGS	UNIT
Supply Voltage	$V_{SS}$	2.7 ~ 5.5	V
Supply Voltage ( $V^+ - V^-$ )	$V_{SS}$	5.5	V
Differential Input Voltage	$V_{I(DIFF)}$	$\pm$ Supply Voltage	
Output Short Circuit	$V^+$	(Note 2)	
	$V^-$	(Note 3)	
Infrared (15 sec)		215	$^{\circ}$ C
Junction Temperature	$T_J$	+150	$^{\circ}$ C
Operation Temperature	$T_{OPR}$	-40 ~ +85	$^{\circ}$ C
Storage Temperature	$T_{STG}$	-65 ~ +150	$^{\circ}$ C

Notes: 1. Absolute maximum ratings are those values beyond which the device could be permanently damaged.

Absolute maximum ratings are stress ratings only and functional device operation is not implied.

2. Shorting output to  $V^+$  will adversely affect reliability.

3. Shorting output to  $V^-$  will adversely affect reliability

### ■ THERMAL DATA

PARAMETER	SYMBOL	RATING	UNIT
Junction to Ambient	SOT-25	265	$^{\circ}$ C/W
	SOT-353	478	$^{\circ}$ C/W

### ■ 2.7V ELECTRICAL CHARACTERISTICS

All limits guaranteed for  $T_J = 25^{\circ}$ C,  $V^+ = 2.7$ V,  $V^- = 0$ V,  $V_{CM} = 1.0$ V,  $V_{OUT} = V^+/2$  and  $R_L > 1$ M $\Omega$ , unless otherwise specified.

PARAMETER	SYMBOL	CONDITIONS	MIN	TYP	MAX	UNIT
<b>DC CHARACTERISTICS</b>						
Input Offset Voltage	$V_{OS}$			1.7	7	mV
Input Common Mode Voltage Range	$V_{CM}$	For $CMRR \geq 50$ dB	0	-0.2		V
			1.7	1.9		V
Output Swing	$V_{OUT}$	$R_L = 10$ k $\Omega$ to 1.35V	$V^+ - 100$	$V^+ - 25$		mV
				15	100	mV
Input Offset Voltage Average Drift	$TCV_{OS}$			5		$\mu$ V/ $^{\circ}$ C
Input Bias Current	$I_{I(BIAS)}$			11	250	nA
Input Offset Current	$I_{I(OFF)}$			5	50	nA
Common Mode Rejection Ratio	CMRR	$0V \leq V_{CM} \leq 1.7V$	50	63		dB
Power Supply Rejection Ratio	PSRR	$2.7V \leq V^+ \leq 5V, V_{OUT} = 1V$	50	60		dB
Supply Current	$I_{SS}$			80	170	$\mu$ A
<b>AC CHARACTERISTICS</b>						
Gain Bandwidth Product	GBWP	$C_L = 200$ pF		1		MHz
Phase Margin	$\Phi_m$			60		Deg
Gain Margin	$G_m$			10		dB
Input Referred Voltage Noise	eN	F=1kHz		46		$\frac{nV}{\sqrt{Hz}}$
Input Referred Current Noise	$i_n$	F=1kHz		0.17		$\frac{pA}{\sqrt{Hz}}$

### ■ 5V ELECTRICAL CHARACTERISTICS

All limits guaranteed for  $T_J = 25^\circ\text{C}$ ,  $V^+ = 5\text{V}$ ,  $V^- = 0\text{V}$ ,  $V_{\text{CM}} = 2.0\text{V}$ ,  $V_{\text{OUT}} = V^+/2$  and  $R_L > 1\text{M}\Omega$ , unless otherwise specified.

PARAMETER	SYMBOL	CONDITIONS	MIN	TYP	MAX	UNIT
<b>DC CHARACTERISTICS</b>						
Input Offset Voltage	$V_{\text{OS}}$			1.7	7	mV
Input Common-Mode Voltage Range	$V_{\text{CM}}$	For $\text{CMRR} \geq 50\text{dB}$		-0.2	0	V
			4.0	4.2		V
Output Swing	$V_{\text{OUT}}$	$R_L = 2\text{k}\Omega$ to $2.5\text{V}$	$V_{\text{OH}}$	$V^+ - 120$	$V^+ - 25$	mV
			$V_{\text{OL}}$		20	120
		$R_L = 10\text{k}\Omega$ to $2.5\text{V}$	$V_{\text{OH}}$	$V^+ - 100$	$V^+ - 20$	mV
			$V_{\text{OL}}$		15	100
Input Offset Voltage Average Drift	$\text{TCVos}$			5		$\mu\text{V}/^\circ\text{C}$
Input Bias Current	$I_{\text{I(BIAS)}}$			15	250	nA
Input Offset Current	$I_{\text{I(OFF)}}$			5	50	nA
Common Mode Rejection Ratio	CMRR	$0\text{V} \leq V_{\text{CM}} \leq 4\text{V}$	50	65		dB
Power Supply Rejection Ratio	PSRR	$2.7\text{V} \leq V^+ \leq 5\text{V}$ $V_{\text{OUT}} = 1\text{V}$ , $V_{\text{CM}} = 1\text{V}$	50	60		dB
Large Signal Voltage Gain(Note 1)	$G_V$	$R_L = 2\text{k}\Omega$	15	100		V/mV
Output Short Circuit Current	$I_{\text{OUT}}$	Sourcing, $V_{\text{OUT}} = 0\text{V}$	5	60		mA
		Sinking, $V_{\text{OUT}} = 5\text{V}$	10	160		mA
Supply Current	$I_{\text{SS}}$			130	250	$\mu\text{A}$
<b>AC CHARACTERISTICS</b>						
Slew Rate	SR	(Note 2)		0.8		V/ $\mu\text{s}$
Gain Bandwidth Product	GBWP	$C_L = 200\text{pF}$		1		MHz
Phase Margin	$\Phi_m$			60		Deg
Gain Margin	$G_m$			10		dB
Input Referred Voltage Noise	eN	$f = 1\text{kHz}$		39		$\frac{\text{nV}}{\sqrt{\text{Hz}}}$
Input Referred Current Noise	$i_n$	$f = 1\text{kHz}$		0.21		$\frac{\text{pA}}{\sqrt{\text{Hz}}}$

Notes: 1.  $R_L$  is connected to  $V^-$ . The output voltage is  $0.5\text{V} \leq V_{\text{OUT}} \leq 4.5\text{V}$ .

2. Connected as voltage follower with 3V step input.

3. All numbers are typical, and apply for packages soldered directly note a PC board is still air.

## TYPICAL CHARACTERISTICS

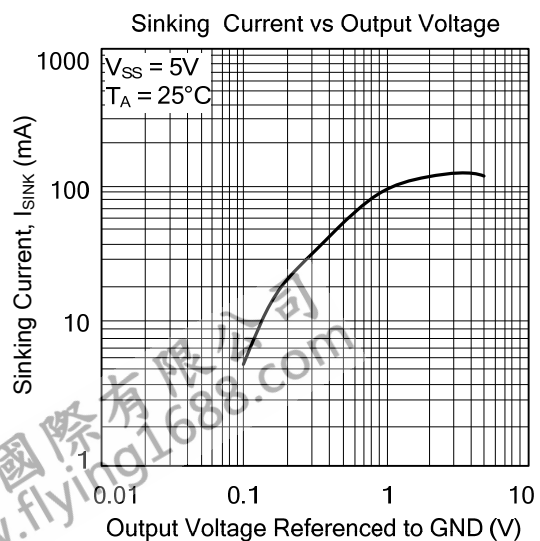
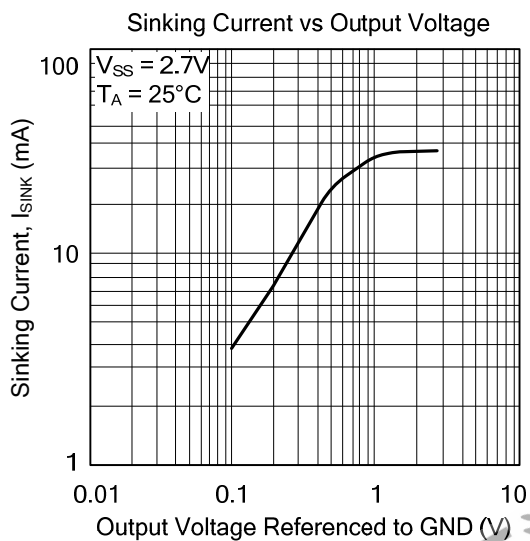
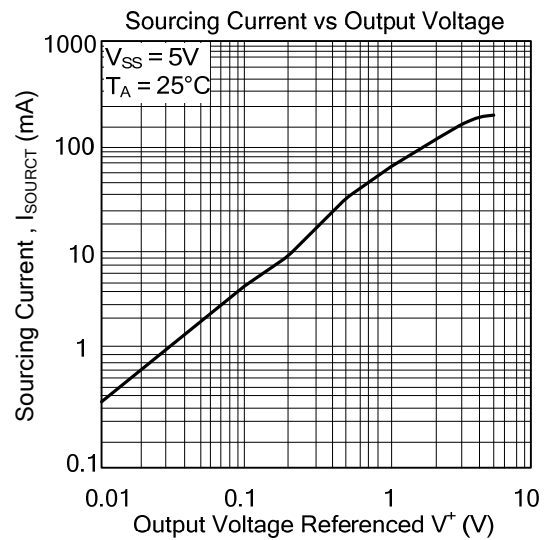
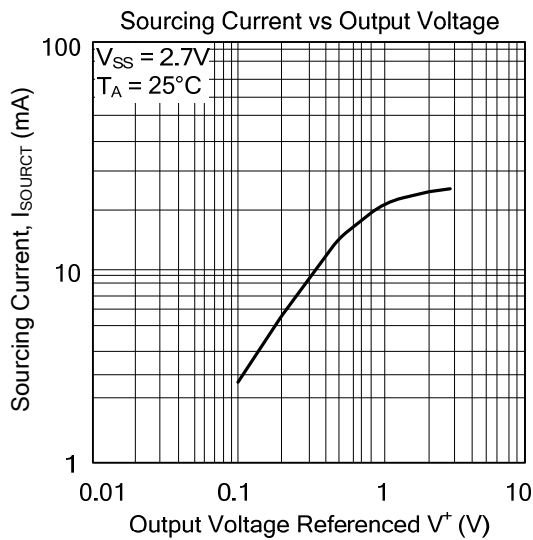
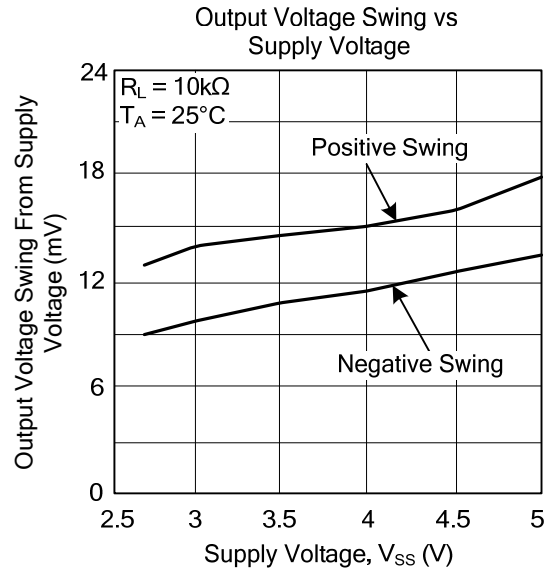
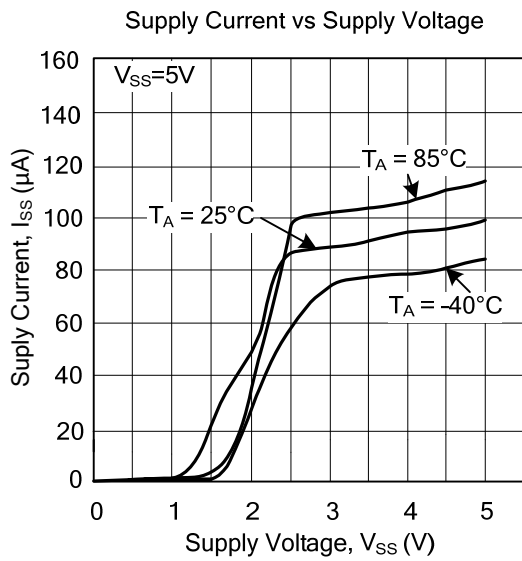

## TYPICAL CHARACTERISTICS (Cont.)

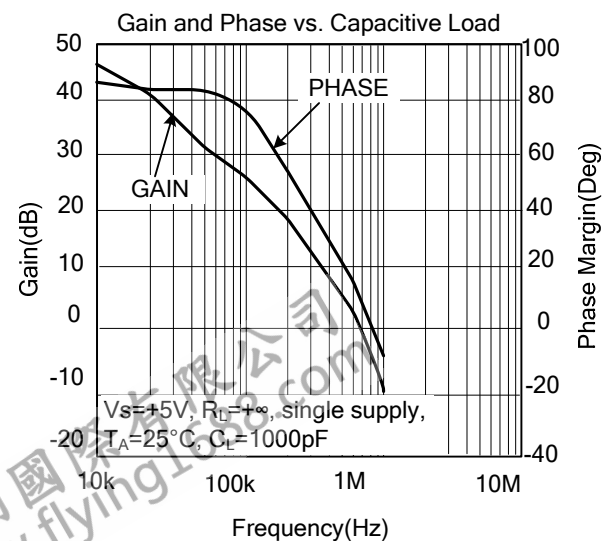
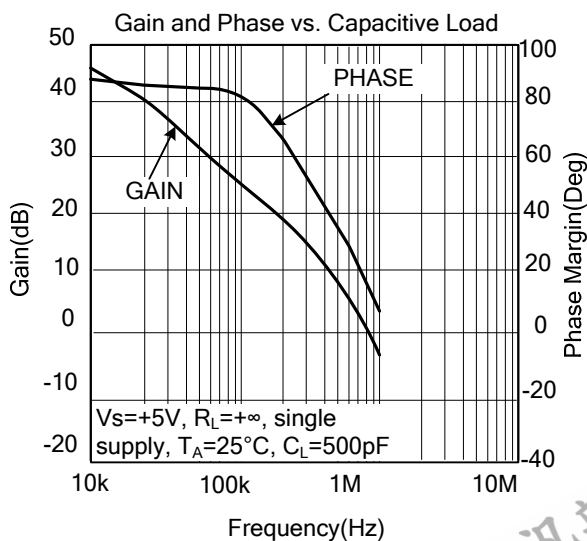
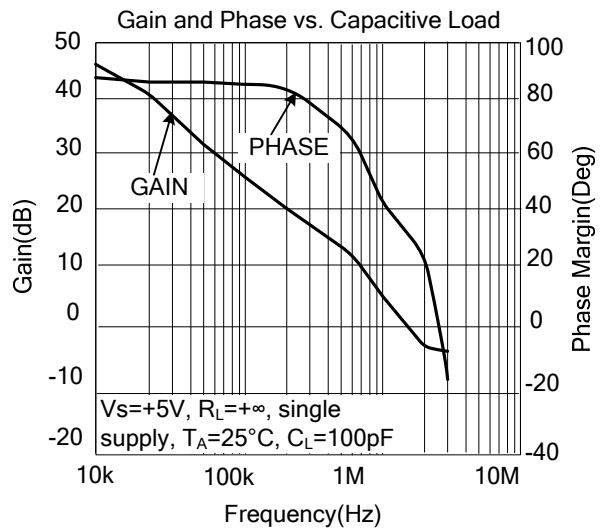
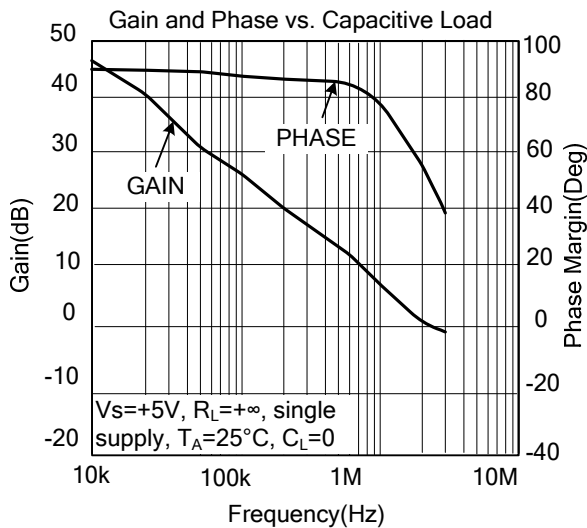
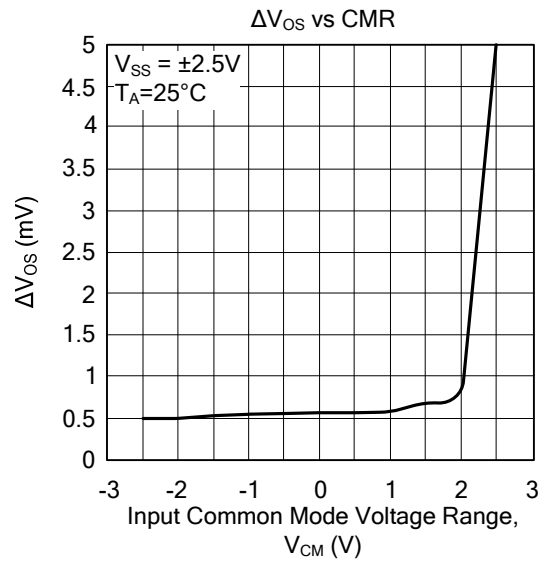
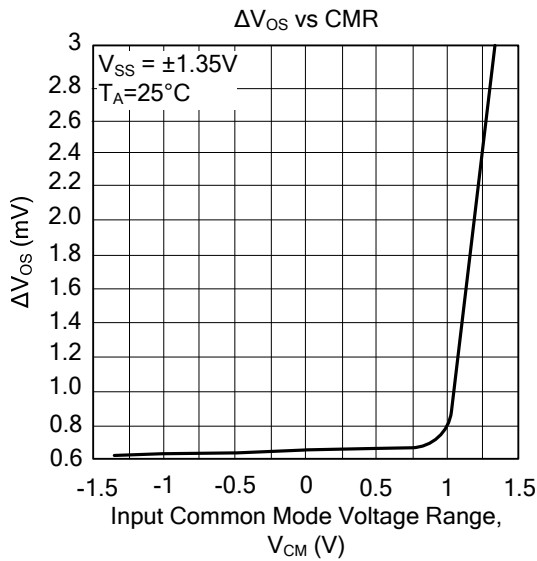

■ TYPICAL CHARACTERISTICS (Cont.)

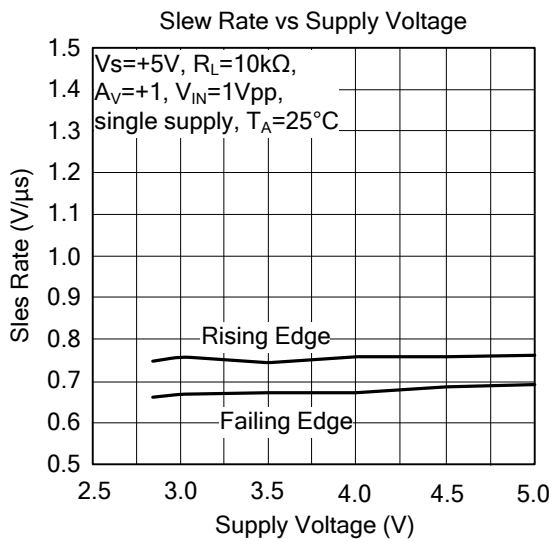
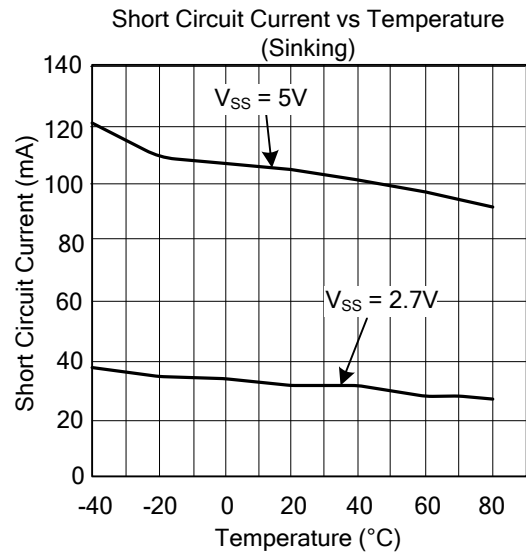
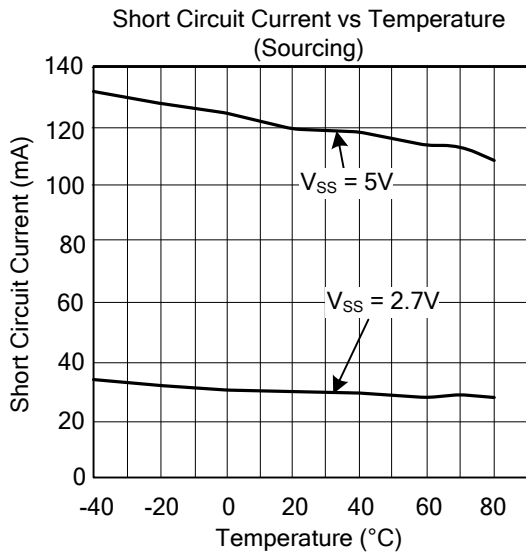

■ TYPICAL CHARACTERISTICS (Cont.)

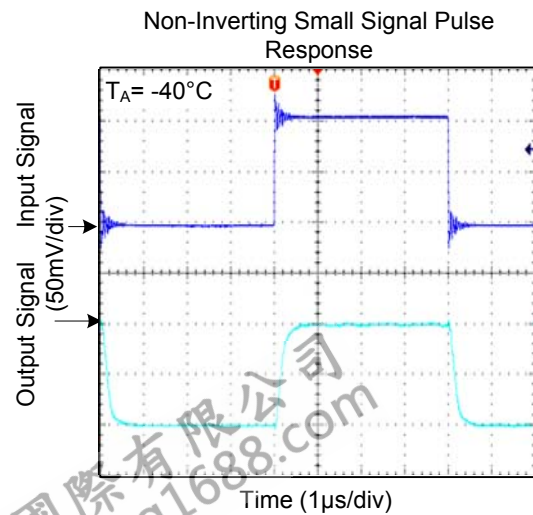
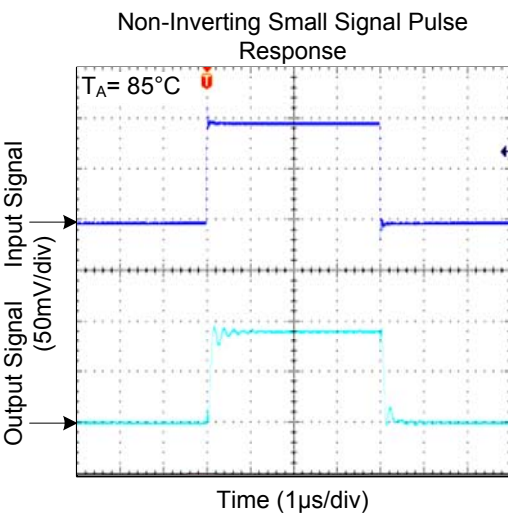
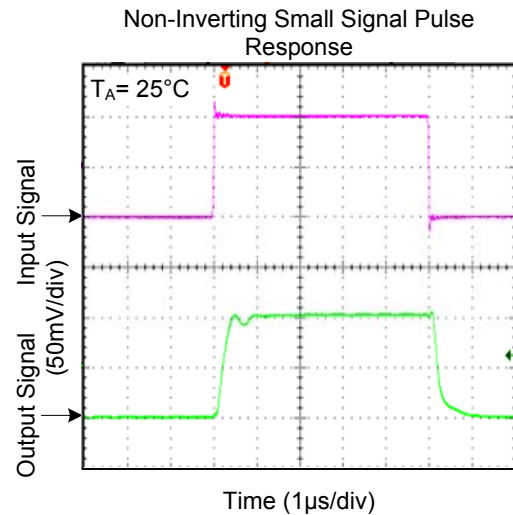
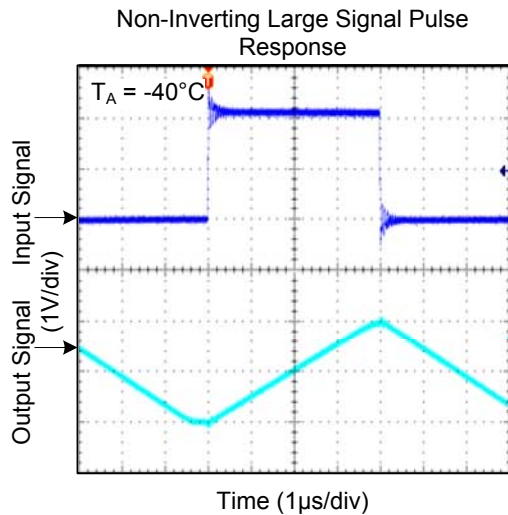
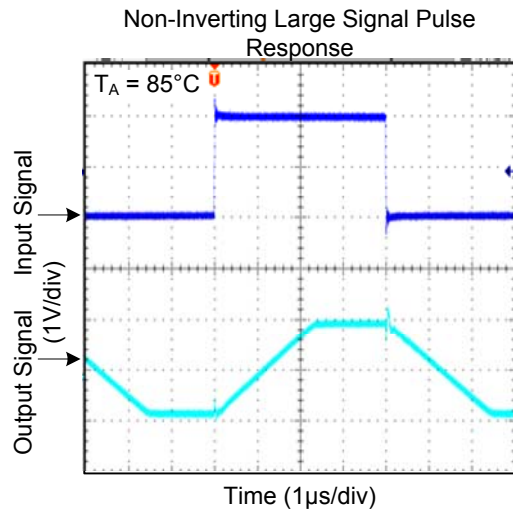
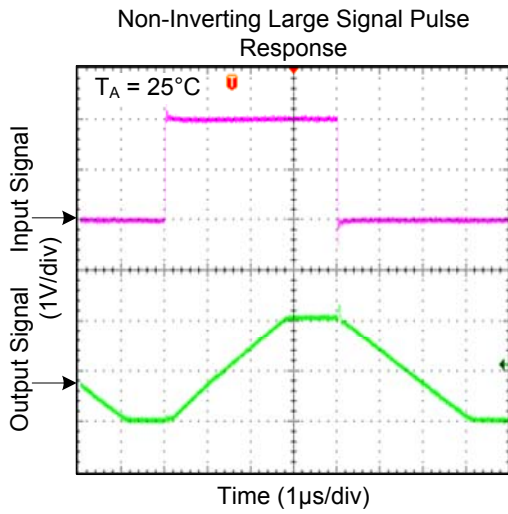



## ■ TYPICAL CHARACTERISTICS (Cont.)

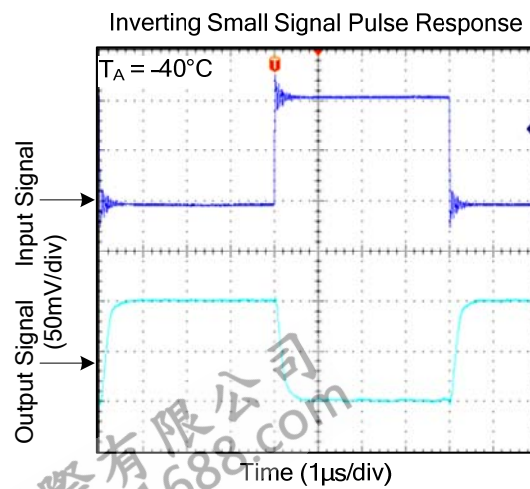
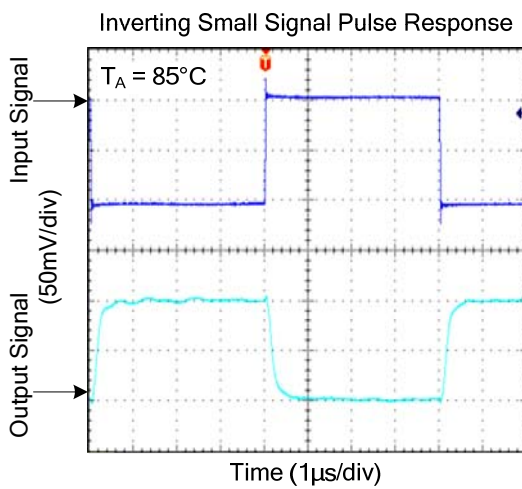
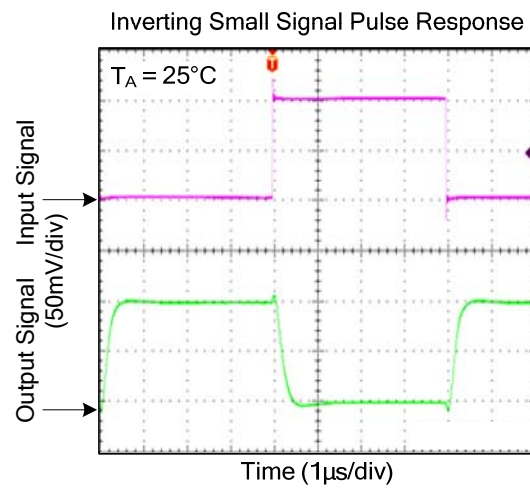
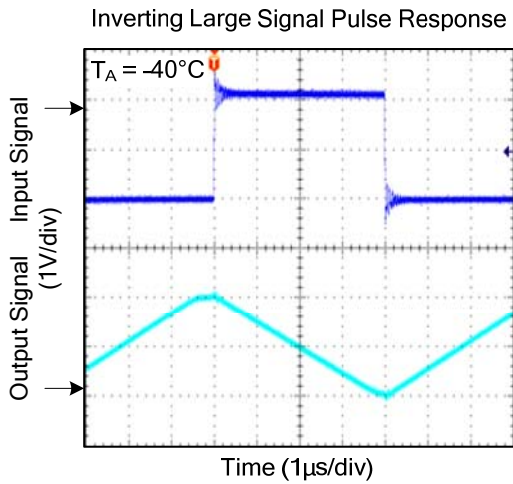
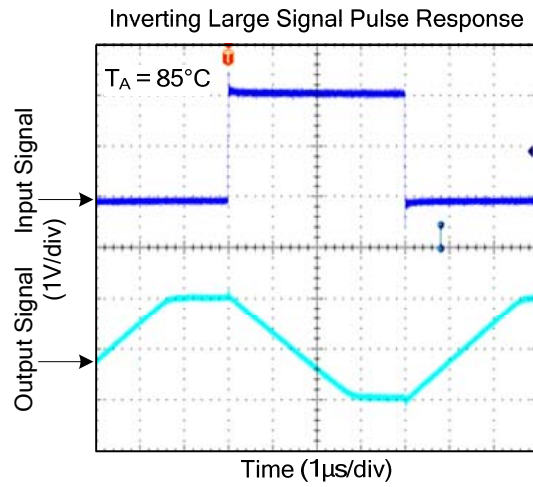
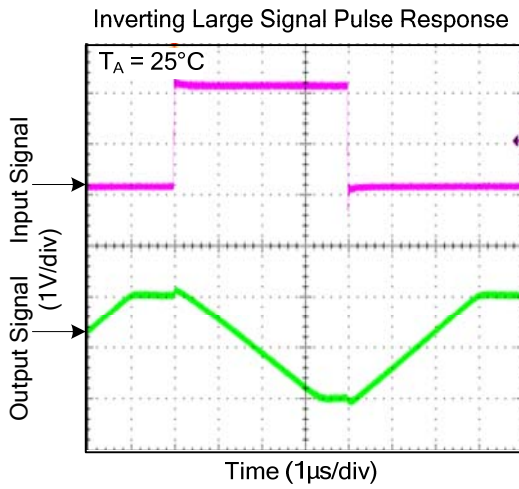

UTC assumes no responsibility for equipment failures that result from using products at values that exceed, even momentarily, rated values (such as maximum ratings, operating condition ranges, or other parameters) listed in products specifications of any and all UTC products described or contained herein. UTC products are not designed for use in life support appliances, devices or systems where malfunction of these products can be reasonably expected to result in personal injury. Reproduction in whole or in part is prohibited without the prior written consent of the copyright owner. UTC reserves the right to make changes to information published in this document, including without limitation specifications and product descriptions, at any time and without notice. This document supersedes and replaces all information supplied prior to the publication hereof.