



MC34074

LINEAR INTEGRATED CIRCUIT

HIGH SLEW RATE, WIDE BANDWIDTH, SINGLE SUPPLY OPERATIONAL AMPLIFIER

DESCRIPTION

The UTC **MC34074** offer 4.5MHz of gain bandwidth product, 13V/ μ s slew rate and fast setting time without the use of JFET device technology. Although it can be operated from split supplies, it is particularly suited for single supply operation, since the common mode input voltage range includes ground potential (V_{EE}). With A Darlington input stage, it exhibits high input resistance, low input offset voltage and high gain. The all NPN output stage, characterized by no deadband crossover distortion and large output voltage swing, provides high capacitance drive capability, excellent phase and gain margins, low open loop high frequency output impedance and symmetrical source/sink AC frequency response.

FEATURES

- * Wide bandwidth: 4.5MHz
- * High slew rate: 13V/ μ s
- * Fast settling time: 1.1 μ s to 0.1%
- * Wide single supply operation: 3.0V to 44V
- * Wide input common mode voltage range:
Includes Ground (V_{EE})
- * Low input offset voltage: 3.0mV maximum
- * Large output voltage swing: -14.7V to +14V
(with \pm 15V supplies)
- * Large Capacitance Drive Capability: 0pF to 10,000pF
- * Low total harmonic distortion: 0.02%
- * Excellent phase margin: 60°
- * Excellent gain margin: 12dB
- * Output short circuit protection
- * ESD Diodes/Clamps provide input protection

ORDERING INFORMATION

Ordering Number		Package	Packing
Lead Free	Halogen Free		
MC34074L-D14-T	MC34074G-D14-T	DIP-14	Tube
MC34074L-S14-R	MC34074G-S14-R	SOP-14	Tape Reel

<p>MC34074G-D14-T</p>	<p>(1) Packing Type (2) Package Type (3) Green Package</p>	<p>(1) T: Tube, R: Tape Reel (2) D14: DIP-14, S14: SOP-14 (3) G: Halogen Free and Lead Free, L: Lead Free</p>
-----------------------	--	---

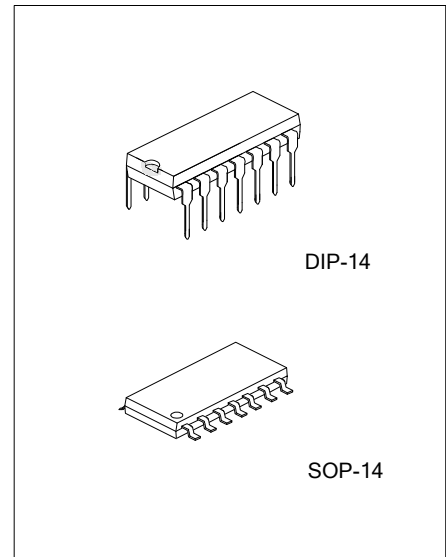

MC34074

LINEAR INTEGRATED CIRCUIT

MARKING

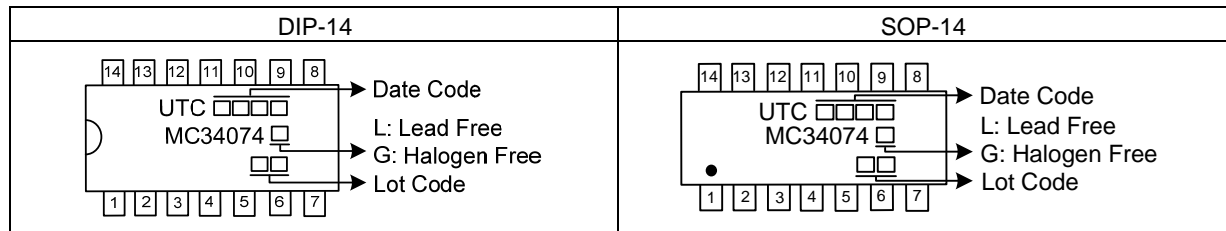

PIN CONFIGURATIONS

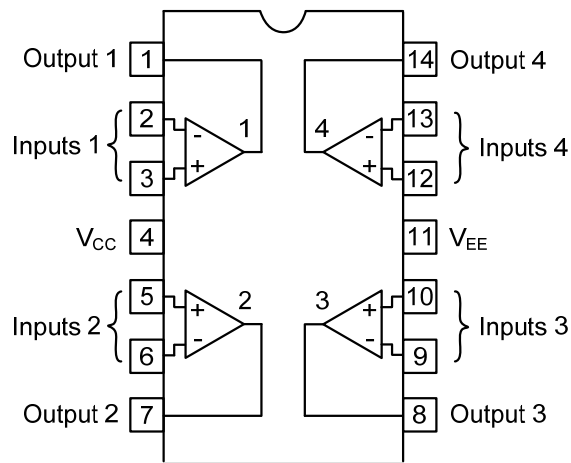

Figure 1.

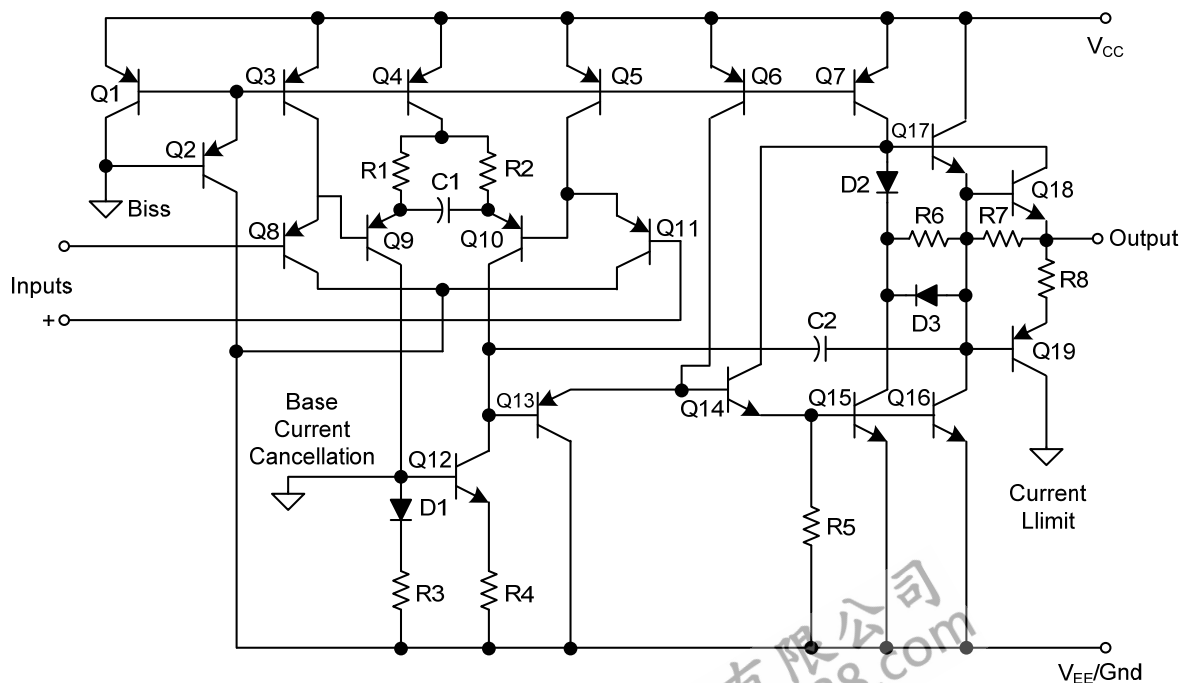

Figure 2. Representative Schematic Diagram

■ ABSOLUTE MAXIMUM RATINGS (T_A=25°C, unless otherwise specified)

PARAMETER	SYMBOL	VALUE	UNIT
Supply Voltage (from V _{EE} to V _{CC})	V _S	+44	V
Differential Input Voltage	V _{IDR}	Note 2	V
Input Voltage	V _{IR}	Note 2	V
Output Short Circuit Duration (Note 3)	t _{SC}	Indefinite	sec
Junction Temperature	T _J	+150	°C
Operating Temperature (Note 4)	T _{OPR}	-40 ~ +85	°C
Storage Temperature	T _{STG}	-60 ~ +150	°C

Notes: 1. Absolute maximum ratings are those values beyond which the device could be permanently damaged.

Absolute maximum ratings are stress ratings only and functional device operation is not implied.

2. Either or both input voltages should not exceed the magnitude of V_{CC} or V_{EE}.

3. Power dissipation must be considered to ensure maximum junction temperature (T_J) is not exceeded. (see Figure 2)

4. It is guarantee by design, not 100% be tested.

■ ELECTRICAL CHARACTERISTICS

(V_{CC}=+15V, V_{EE}=-15V, R_L=connected to ground, unless otherwise specified)

PARAMETER	SYMBOL	TEST CONDITIONS	MIN	TYP	MAX	UNIT
Input Offset Voltage	V _{I(OFF)}	R _S =100Ω, V _{CM} =0V, V _O =0V, V _{CC} =+15V, V _{EE} =-15V, T _A =+25°C		0.5	3.0	mV
		V _{CC} =+5V, V _{EE} =0V, T _A =+25°C		0.5	3.0	mV
		V _{CC} =+15V, V _{EE} =-15V, T _A =0°C to 70°C				5.0
Average Temperature Coefficient of Input Offset Voltage	ΔV _{I(OFF)} /ΔT	R _S =10Ω, V _{CM} =0V, V _{OUT} =0V, T _A =0°C to 70°C		10		μV/°C
Input Bias Current	I _{I(BIAS)}	V _{CM} =0V, V _O =0V	T _A = T _A =+25°C	100	500	nA
			T _A =0°C to 70°C			
Input Offset Current	I _{I(OFF)}	V _{CM} =0V, V _O =0V	T _A = T _A =+25°C	6.0	50	nA
			T _A =0°C to 70°C			
Input Common Mode Voltage	V _{I(CM)}	T _A = T _A =+25°C	V _{EE} to (V _{CC} -1.8)		V	
		T _A =0°C to 70°C	V _{EE} to (V _{CC} -2.2)		V	
Large Signal Voltage Gain	G _V	V _{OUT} =±10V, R _L =2.0kΩ	T _A = T _A =+25°C	50	100	V/mV
			T _A =0°C to 70°C	25		
Output Voltage Swing (V _{ID} =±1.0V)	V _{OH}	V _{CC} =+5.0V, V _{EE} =0V, R _L =2.0kΩ, T _A =+25°C	3.7	4.0		V
		V _{CC} =+15.0V, V _{EE} =-15V, R _L =10kΩ, T _A =+25°C	13.6	14		V
		V _{CC} =+15.0V, V _{EE} =-15V, R _L =2.0kΩ, T _A =0°C to 70°C	13.4			V
Output Voltage Swing (V _{ID} =±1.0V)	V _{OL}	V _{CC} =+5.0V, V _{EE} =0V, R _L =2.0kΩ, T _A =+25°C		0.1	0.3	V
		V _{CC} =+15.0V, V _{EE} =-15V, R _L =10kΩ, T _A =+25°C		-14.7	-14.3	V
		V _{CC} =+15.0V, V _{EE} =-15V, R _L =2.0kΩ, T _A =0°C to 70°C			-13.5	V
Output Short Circuit current	I _{SC}	V _{ID} =1.0V, V _{OUT} =0V, T _A =25°C	Source	10	30	mA
			Sink	20	30	
Common Mode Rejection	CMR	R _S ≤10kΩ, V _{CM} =V _{ICR} , T _A =+25°C	80	97		dB
Power Supply Rejection (R _S =100Ω)	PSR	V _{CC} /V _{EE} =+16.5V/-16.5V to +13.5V/-13.5V, T _A =25°C	80	97		dB

■ ELECTRICAL CHARACTERISTICS (Cont.)

PARAMETER	SYMBOL	TEST CONDITIONS	MIN	TYP	MAX	UNIT
Power Supply Current (Per Amplifier, No Load)	I_D	$V_{CC}=+5.0V, V_{EE}=0V, V_{OUT}=+2.5V, T_A=+25^\circ C$		1.6	2.0	mA
		$V_{CC}=+15.0V, V_{EE}=-15V, V_{OUT}=0V, T_A=+25^\circ C$		1.9	2.5	mA
		$V_{CC}=+15.0V, V_{EE}=-15V, V_{OUT}=0V, T_A=0^\circ C \text{ to } 70^\circ C$				2.8
Slew Rate	SR	$V_{in}=-10V \text{ to } +10V, R_L=2.0k\Omega, C_L=500pF$		$A_v=+1.0$ $A_v=-1.0$	8.0 10 13	$V/\mu s$
Setting Time	t_s	10 Setp, $A_v=-1.0$			1.1 2.2	μs
Gain Bandwidth Product	G_{BW}	$f=100kHz$	3.5	4.5		MHz
Power Bandwidth	BW	$A_v=+1.0, R_L=2k\Omega, V_{OUT}=20V_{pp}, THD=5.0\%$		160		kHz
Phase Margin	fm	$R_L=2k\Omega$		60		Deg
		$R_L=2k\Omega, C_L=300pF$		40		
Gain Margin	Am	$R_L=2k\Omega$		12		dB
		$R_L=2k\Omega, C_L=300pF$		4		
Equivalent Input Noise Voltage	eN	$R_s=100\Omega, f=1.0kHz$		32		nV/\sqrt{Hz}
Equivalent Input Noise Current	i_n	$f=1.0kHz$		0.22		pA/\sqrt{Hz}
Differential Input Resistance	R_{IN}	$V_{CM}=0V$		150		$M\Omega$
Differential Input Capacitance	C_{IN}	$V_{CM}=0V$		2.5		pF
Total Harmonic distortion	G_N	$A_v=+10, R_L=2.0k\Omega, 2.0V_{pp} \leq V_O \leq 20V_{pp}, f=10kHz$		0.02		%
Channel Separation		$f=10kHz$		120		dB
Open Loop Output Impedance	I_{Zol}	$f=1.0MHz$		30		W

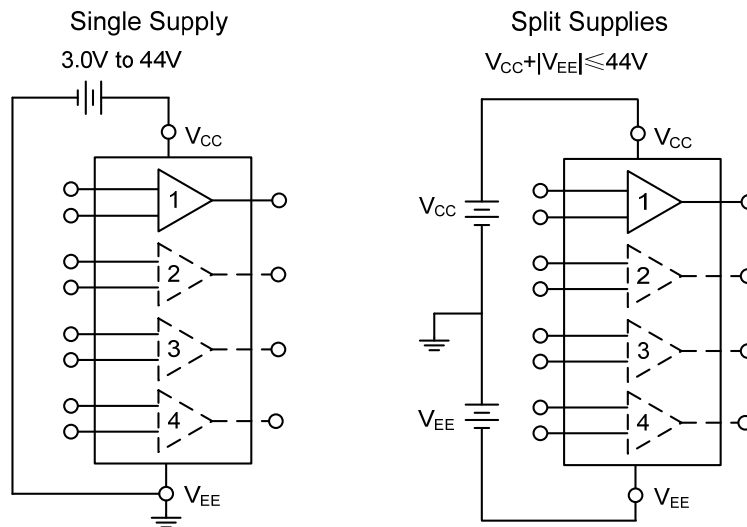
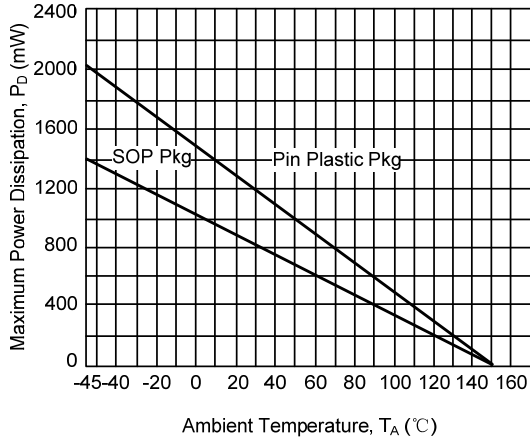

Figure 3. Power Supply Configurations

TYPICAL CHARACTERISTICS

Maximum Power Dissipation vs. Temperature for Package Types



Input Offset Voltage vs. Temperature for Representative Units

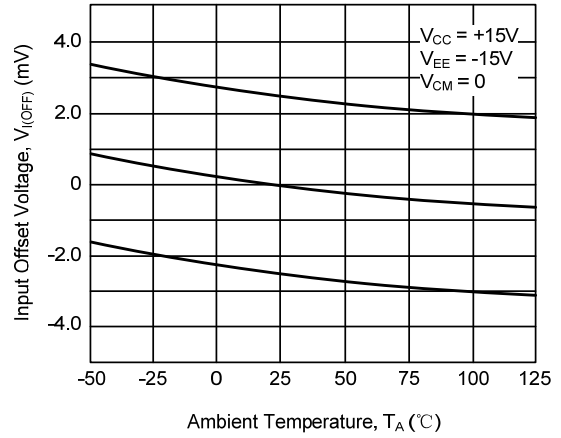

Input Common Mode Voltage Range vs. Temperature

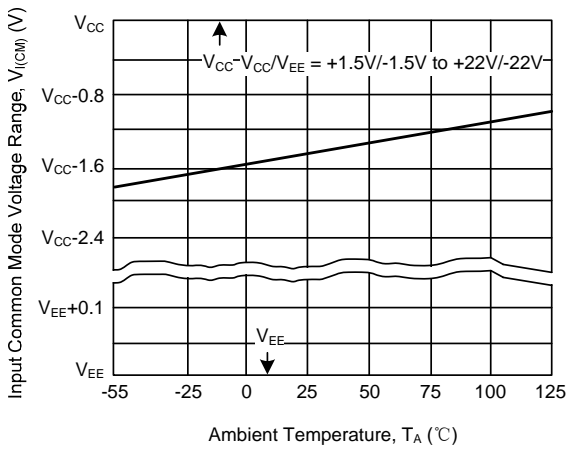

Normalized Input Bias Current vs. Temperature

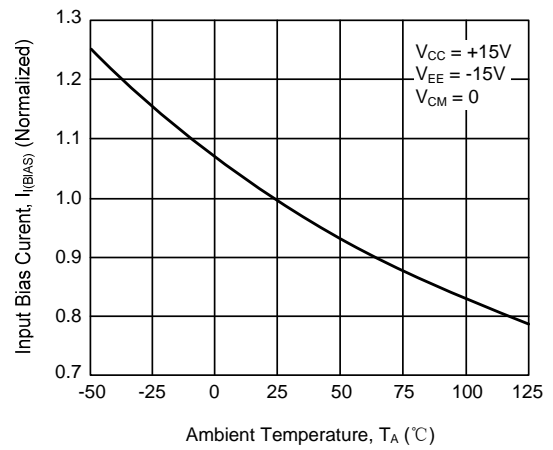

Normalized Input Bias Current vs. Input Common Mode Voltage

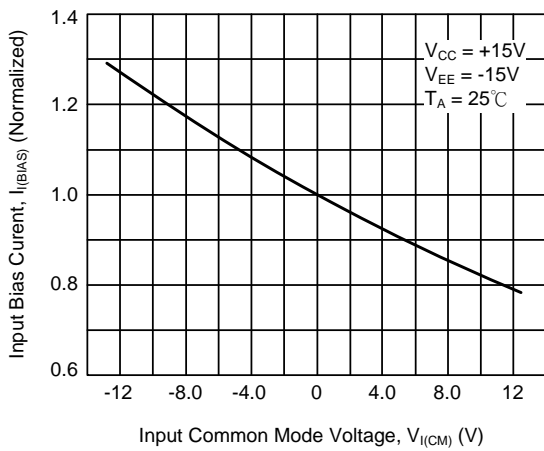

Split Supply Output Voltage Swing vs. Supply Voltage

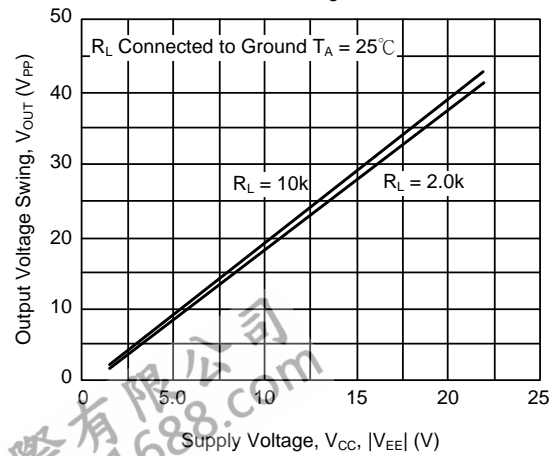

TYPICAL CHARACTERISTICS (Cont.)

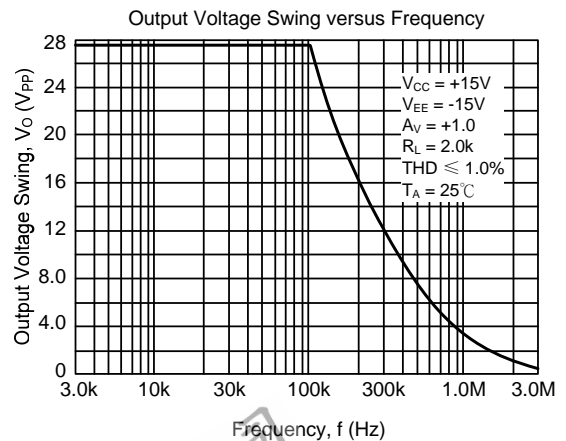
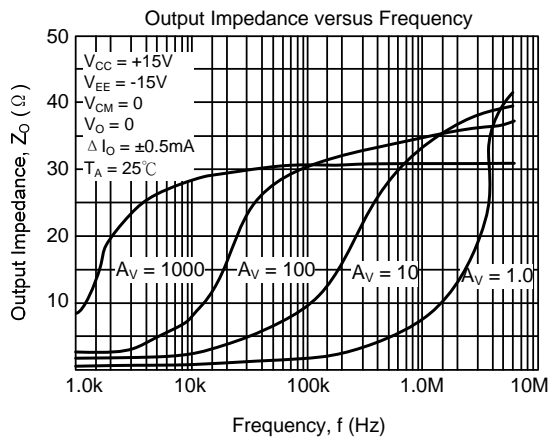
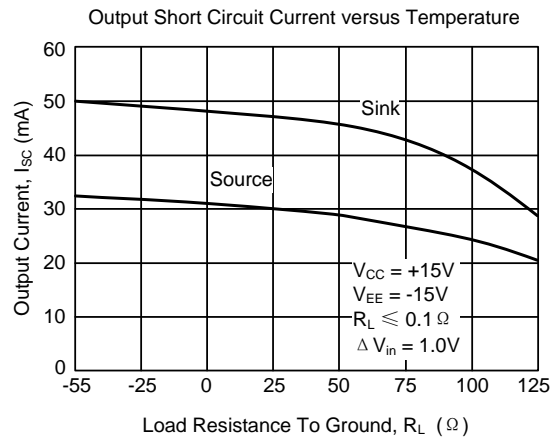
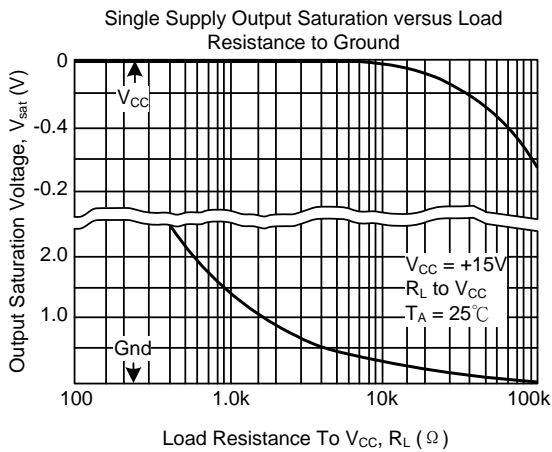
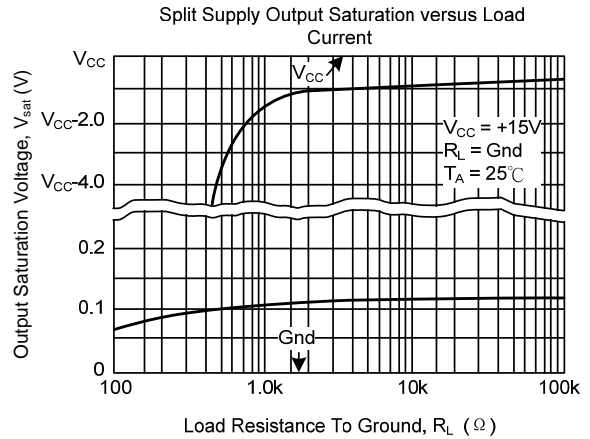
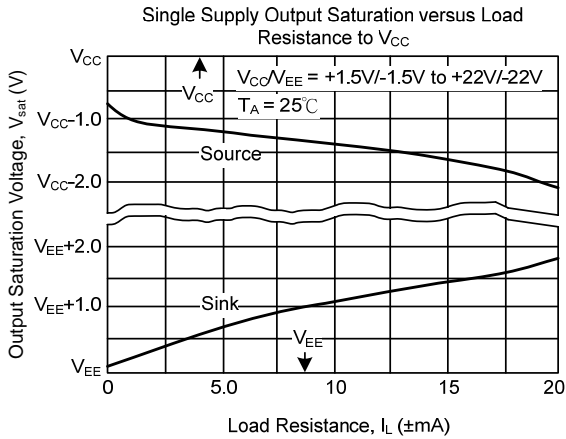

TYPICAL CHARACTERISTICS (Cont.)

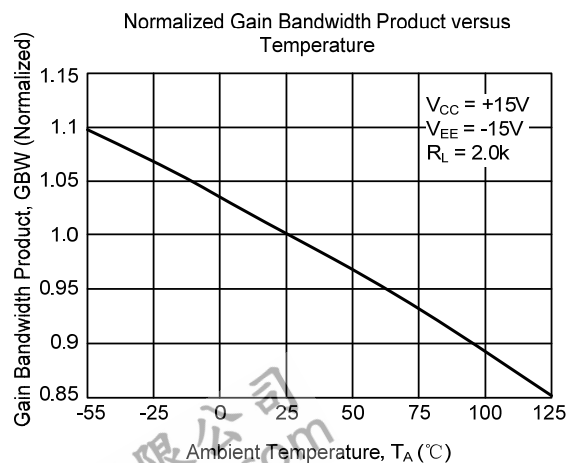
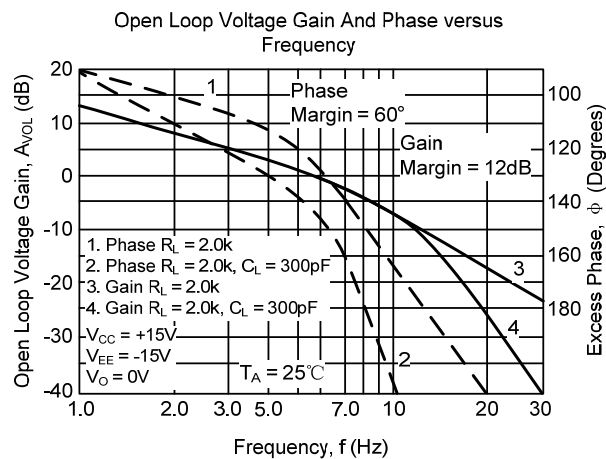
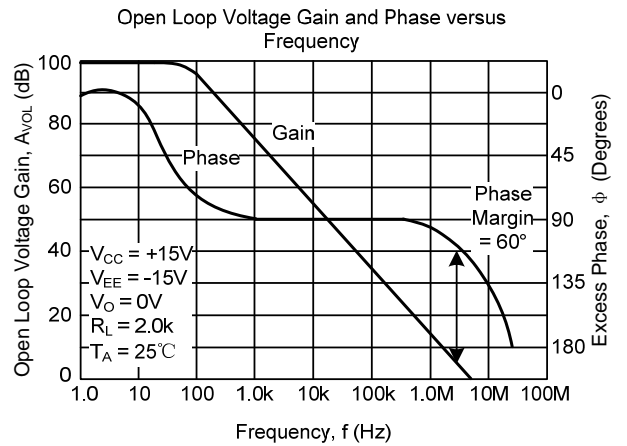
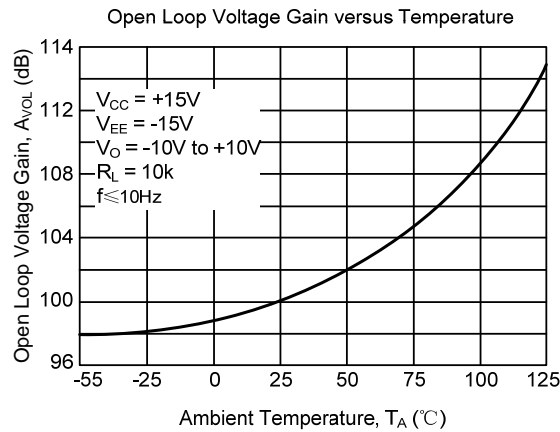
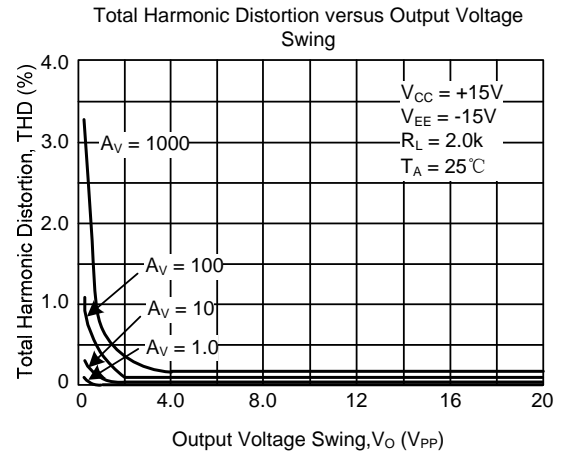
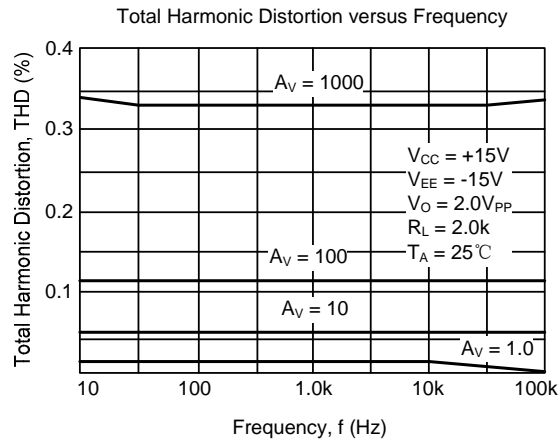

TYPICAL CHARACTERISTICS (Cont.)

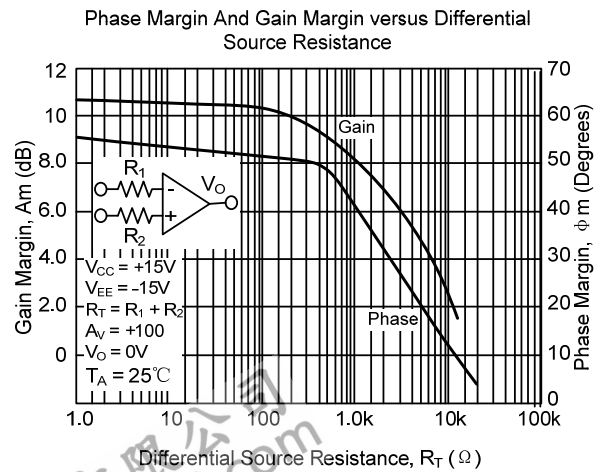
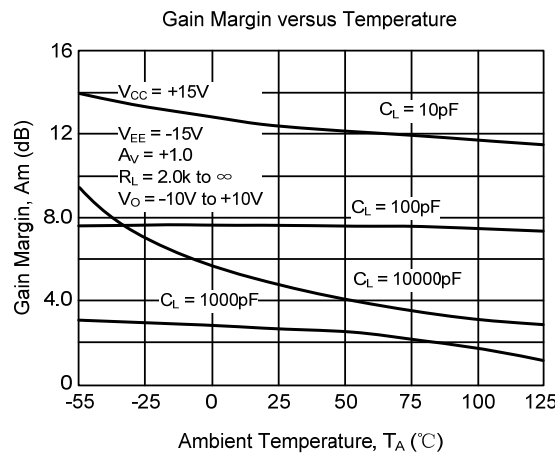
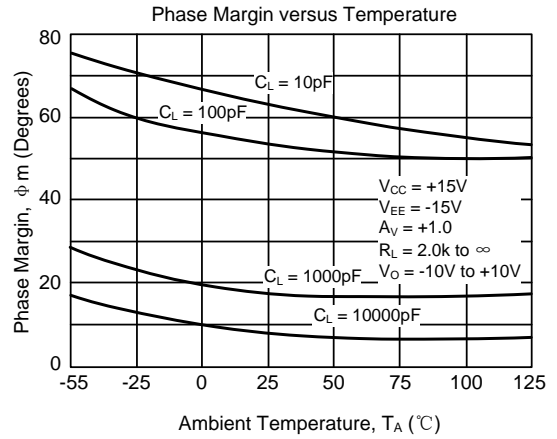
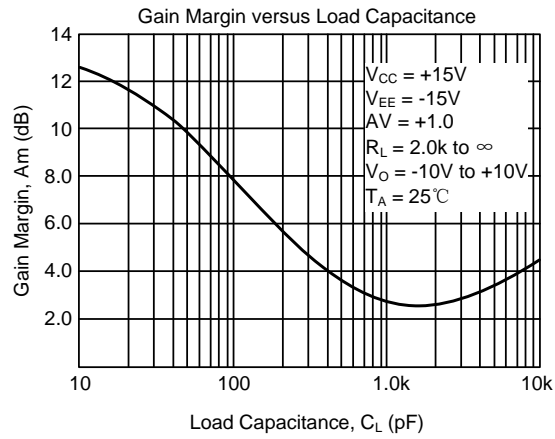
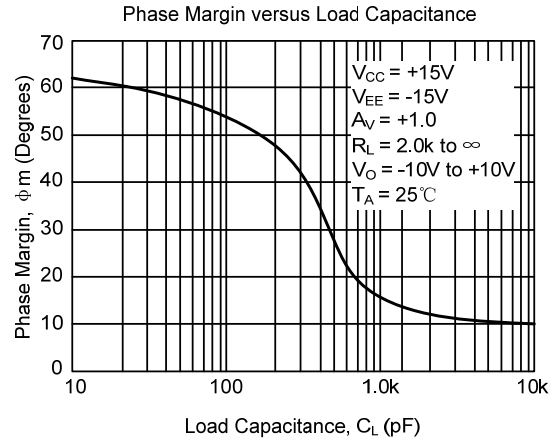
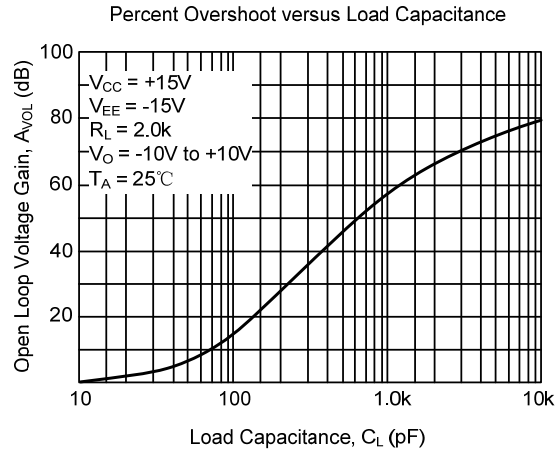

TYPICAL CHARACTERISTICS (Cont.)

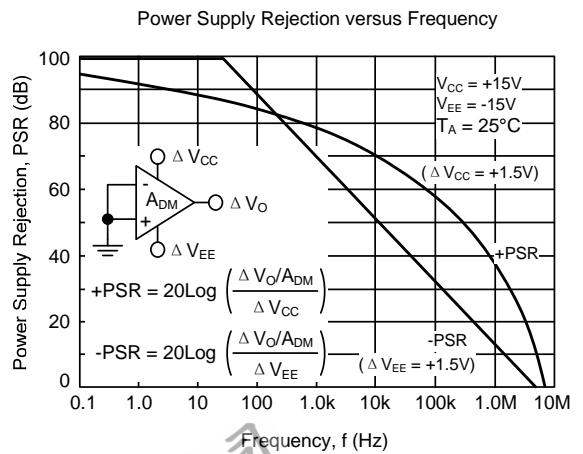
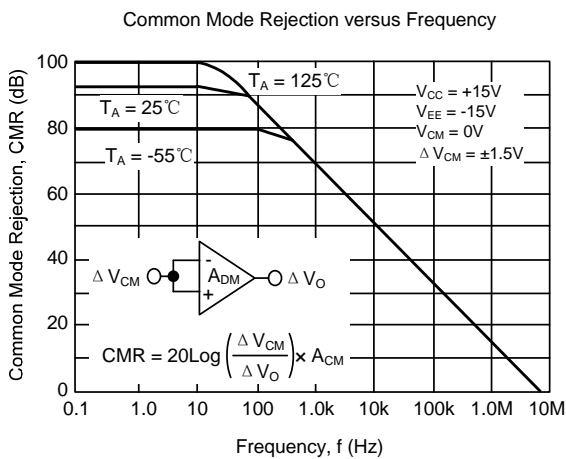
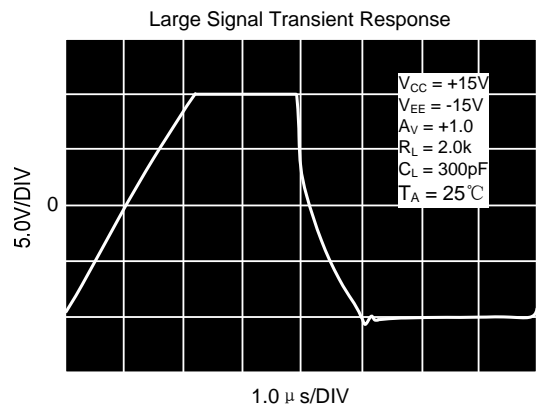
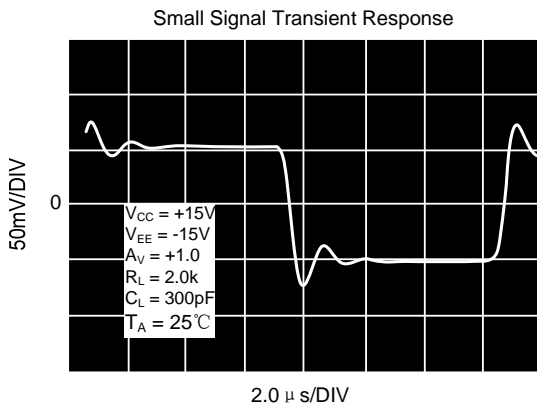
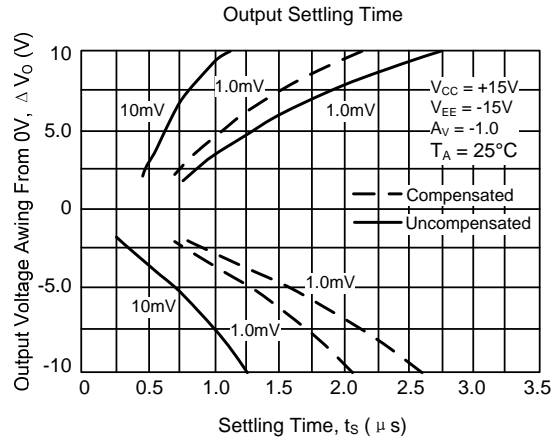
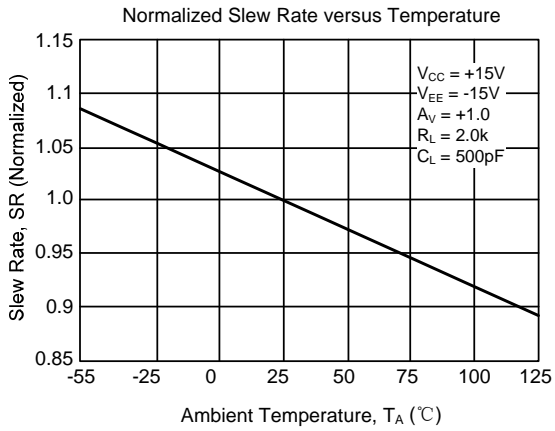

TYPICAL CHARACTERISTICS (Cont.)

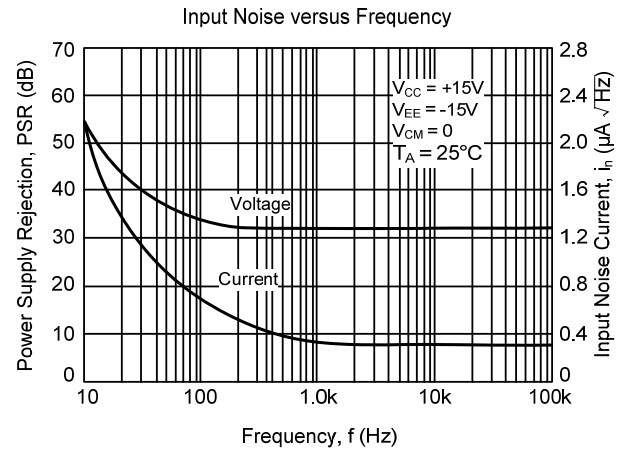
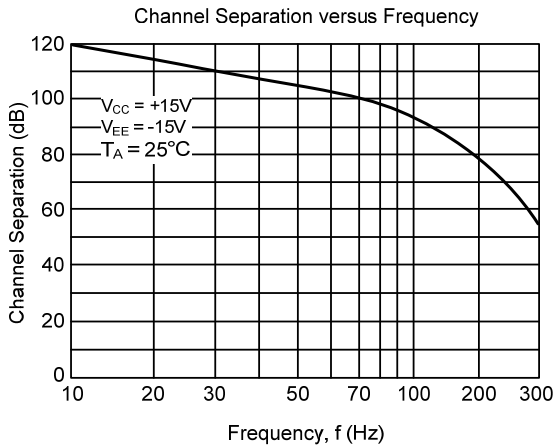
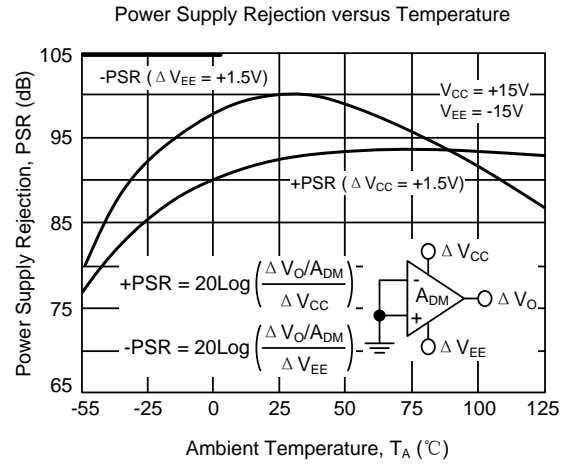
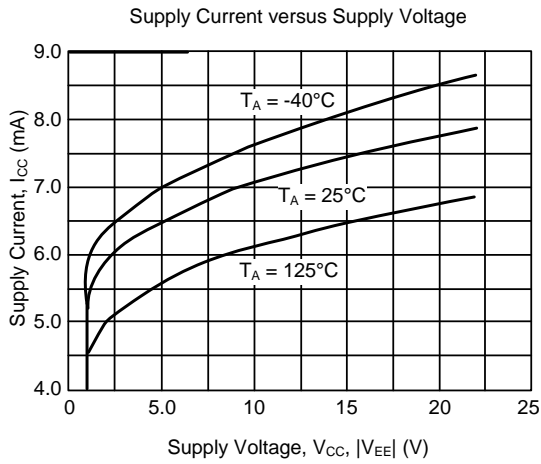

UTC assumes no responsibility for equipment failures that result from using products at values that exceed, even momentarily, rated values (such as maximum ratings, operating condition ranges, or other parameters) listed in products specifications of any and all UTC products described or contained herein. UTC products are not designed for use in life support appliances, devices or systems where malfunction of these products can be reasonably expected to result in personal injury. Reproduction in whole or in part is prohibited without the prior written consent of the copyright owner. UTC reserves the right to make changes to information published in this document, including without limitation specifications and product descriptions, at any time and without notice. This document supersedes and replaces all information supplied prior to the publication hereof.