



## MC4580

## LINEAR INTEGRATED CIRCUIT

### DUAL OPERATIONAL AMPLIFIER

#### DESCRIPTION

The UTC **MC4580** is the dual operational amplifier, specially designed for improving the tone control, which is most suitable for the audio application.

Featuring noiseless, higher gain bandwidth, high output current and low distortion ratio, and it is most suitable not only for acoustic electronic parts of audio pre-amp and active filter, but also for the industrial measurement tools. It is also suitable for the head phone amp at higher output current, and further more, it can be applied for the handy type set operational amplifier of general purpose in application of low voltage single supply type which is properly biased of the input low voltage source.

#### FEATURES

- \*Operating voltage (±2V ~ ±18V)
- \*Low input noise voltage (0.8μVrms typ.)
- \*Wide gain bandwidth product (15MHz typ.)
- \*Low distortion (0.0005% typ.)
- \*Slew rate (5V/μs typ.)
- \*Bipolar technology

#### ORDERING INFORMATION

Ordering Number		Package	Packing
Lead Free	Halogen Free		
MC4580L-D08-T	MC4580G-D08-T	DIP-8	Tube
MC4580L-G08-T	MC4580G-G08-T	SIP-8	Tube
MC4580L-S08-R	MC4580G-S08-R	SOP-8	Tape Reel
MC4580L-P08-R	MC4580G-P08-R	TSSOP-8	Tape Reel
MC4580L-SM1-R	MC4580G-SM1-R	MSOP-8	Tape Reel
MC4580L-K08-2030-R	MC4580G-K08-2030-R	DFN2030-8	Tape Reel

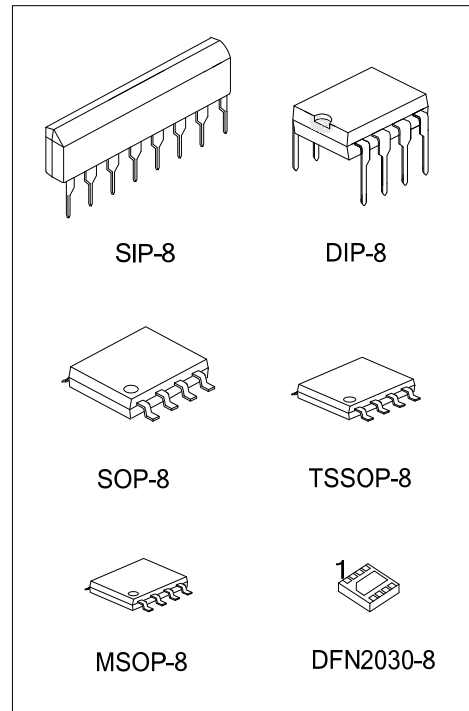

<p>MC4580G-D08-T</p> <p>(1)Packing Type (2)Package Type (3)Green Package</p>	<p>(1) T: Tube, R: Tape Reel (2) D08: DIP-8, G08: SIP-8, P08: TSSOP-8, S08: SOP-8, SM1: MSOP-8, K08-2030: DFN2030-8 (3) G: Halogen Free and Lead Free, L: Lead Free</p>
--	---

# MC4580

## LINEAR INTEGRATED CIRCUIT

### MARKING

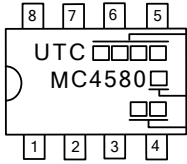
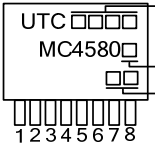
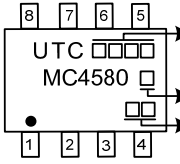
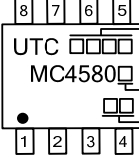
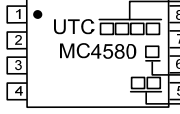
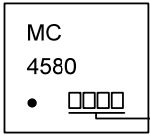
PACKAGE	MARKING
DIP-8	 <p>             UTC □□□□ → Date Code              MC4580 □ → L: Lead Free              □ → G: Halogen Free              □ → Lot Code           </p>
SIP-8	 <p>             UTC □□□□ → Date Code              MC4580 □ → L: Lead Free              □ → G: Halogen Free              □ → Lot Code           </p>
SOP-8	 <p>             UTC □□□□ → Date Code              MC4580 □ → L: Lead Free              □ → G: Halogen Free              □ → Lot Code           </p>
MSOP-8	 <p>             UTC □□□□ → Date Code              MC4580 □ → L: Lead Free              □ → G: Halogen F              □ → Lot Code           </p>
TSSOP-8	 <p>             UTC □□□□ → Date Code              MC4580 □ → L: Lead Free              □ → G: Halogen Free              □ → Lot Code           </p>
DFN2030-8	 <p>             MC              4580              • □□□□ → Date Code           </p>

汎翔國際有限公司  
 www.flying1688.com

## PIN CONFIGURATION

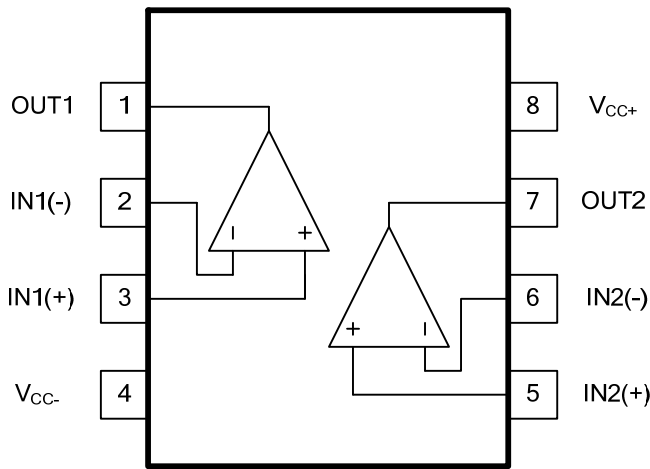

DIP-8/SOP-8/TSSOP-8/MSOP-8/DFN2030-8

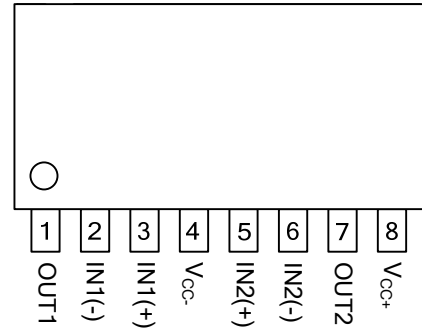

SIP-8

## TEST CIRCUIT

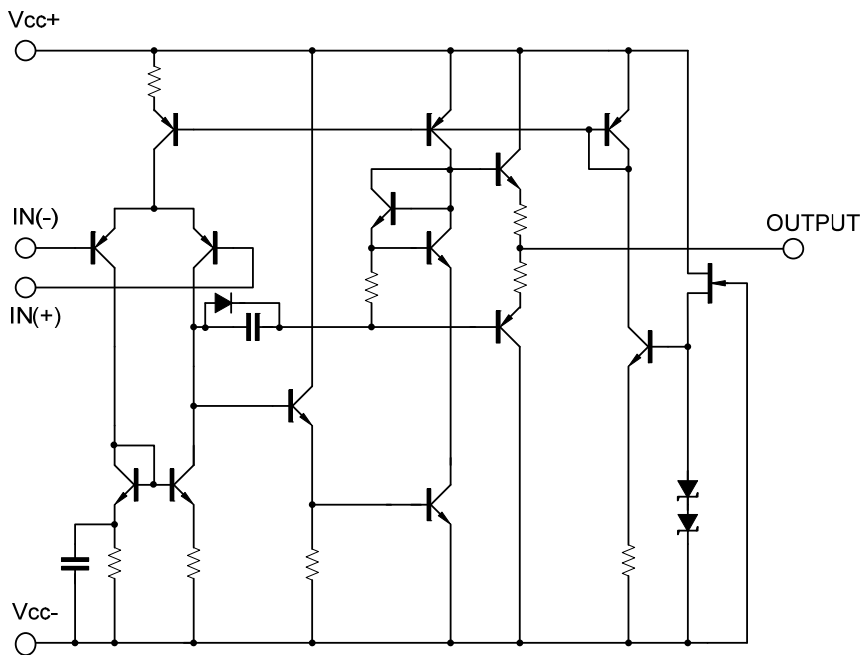

■ ABSOLUTE MAXIMUM RATINGS (T<sub>A</sub>=25°C)

PARAMETER		SYMBOL	RATINGS	UNIT
Supply Voltage		V <sup>+</sup> /V <sup>-</sup>	±18	V
Input Voltage		V <sub>IN</sub>	±15	V
Differential Input Voltage		V <sub>I(DIFF)</sub>	±30	V
Output Current		I <sub>OUT</sub>	±50	mA
Power Dissipation	DIP-8	P <sub>D</sub>	750	mW
	SIP-8			
	SOP-8			
	TSSOP-8			
	MSOP-8			
	DFN2030-8			
Junction Temperature		T <sub>J</sub>	+125	°C
Operating Temperature		T <sub>OPR</sub>	-40 ~ +85	°C
Storage Temperature		T <sub>STG</sub>	-40 ~ +125	°C

Note Absolute maximum ratings are those values beyond which the device could be permanently damaged. Absolute maximum ratings are stress ratings only and functional device operation is not implied.

■ ELECTRICAL CHARACTERISTICS (V<sup>+</sup>/V<sup>-</sup>=±15V, T<sub>A</sub>=25°C)

PARAMETER	SYMBOL	TEST CONDITION	MIN	TYP	MAX	UNIT
Input Offset Voltage	V <sub>I(OFF)</sub>	R <sub>S</sub> ≅ 10kΩ		0.5	3	mV
Input Offset Current	I <sub>I(OFF)</sub>			5	200	nA
Input Bias Current	I <sub>I(BIAS)</sub>			100	500	nA
Large Signal Voltage Gain	G <sub>V</sub>	V <sub>OUT</sub> =±10V, R <sub>L</sub> ≅ 2kΩ	90	110		dB
Output Voltage Swing	V <sub>OM</sub>	R <sub>L</sub> ≅ 2kΩ	±12	±13.5		V
Input Common Mode Voltage	V <sub>I(CM)</sub>		±12	±13.5		V
Common Mode Rejection Ratio	CMRR	R <sub>S</sub> ≅ 10kΩ	80	110		dB
Supply Voltage Rejection Ratio	SVR	R <sub>S</sub> ≅ 10kΩ	80	110		dB
Operating Current	I <sub>CC</sub>			6	9	mA
Slew Rate	SR	R <sub>L</sub> ≅ 2kΩ		5		V/μs
Gain bandwidth Product	GB	f=10KHz		15		MHz
Total Harmonic Distortion	THD	G <sub>v</sub> =20dB, V <sub>OUT</sub> =5V, R <sub>L</sub> =2kΩ, f=1KHz		0.0005		%
Input Noise Voltage	e <sub>N</sub>	RIAA R <sub>S</sub> =2.2 kΩ, 30kHzLPF		0.8		μVrms

## TYPICAL CHARACTERISTICS

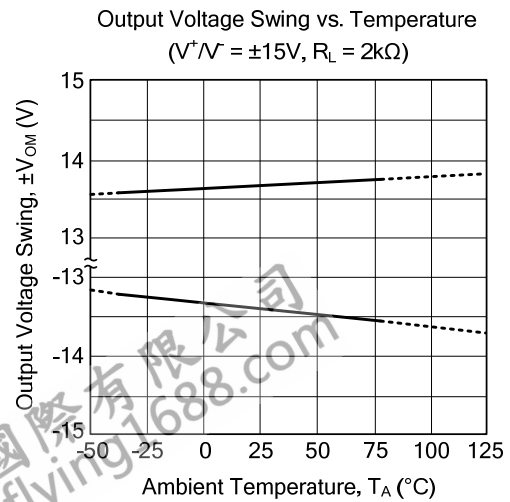
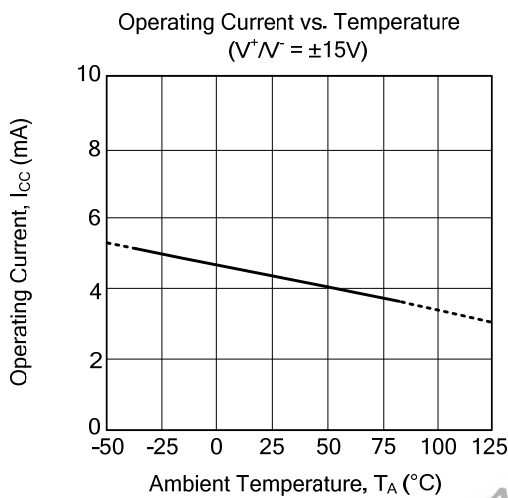
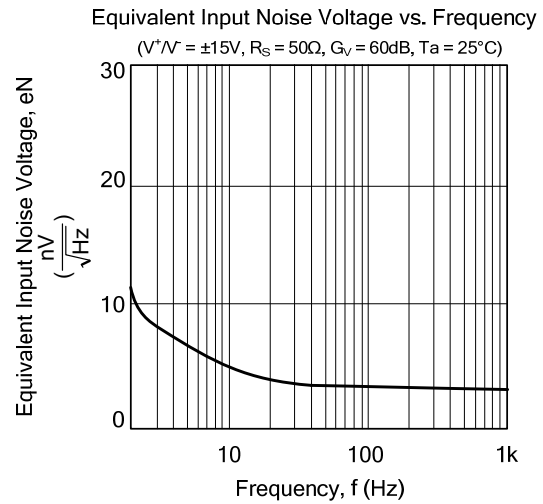
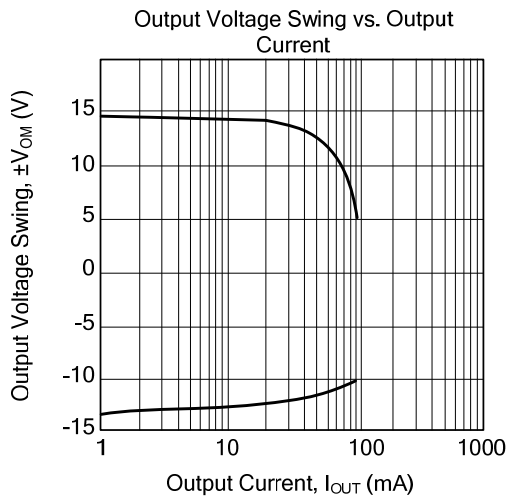
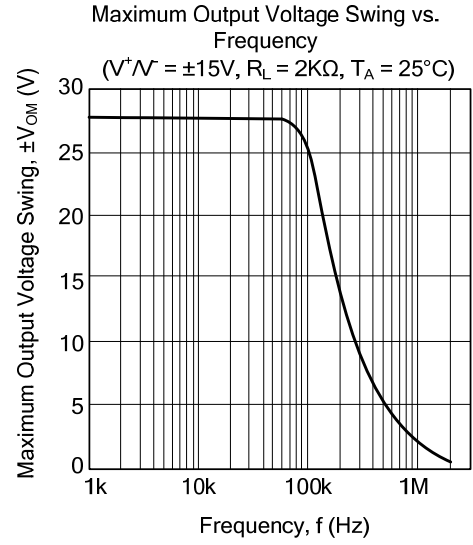
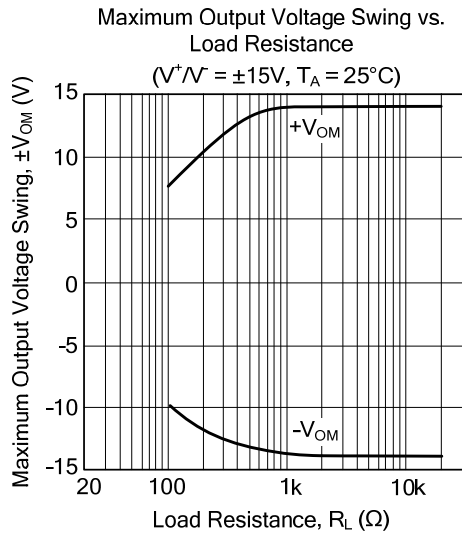

## TYPICAL CHARACTERISTICS(Cont.)

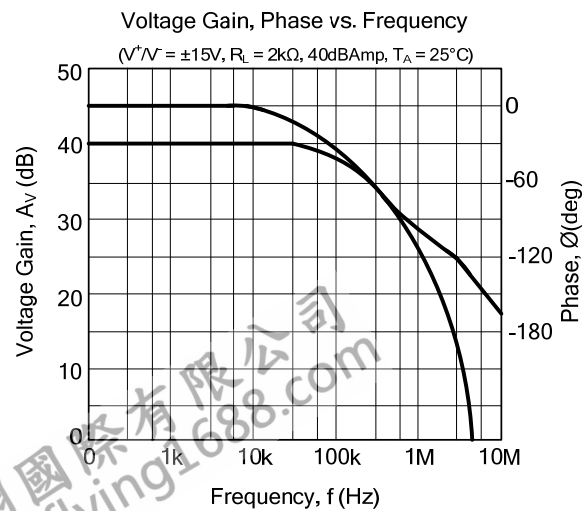
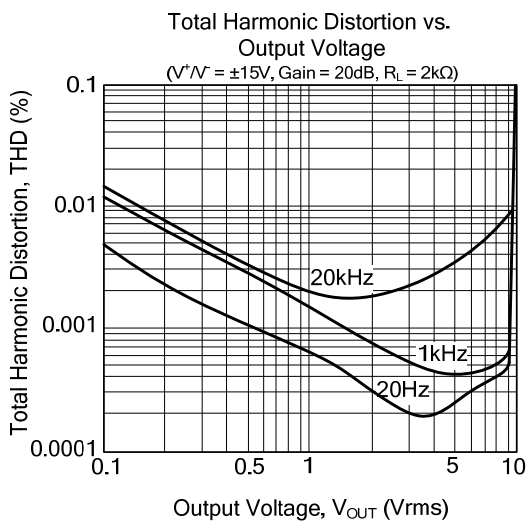
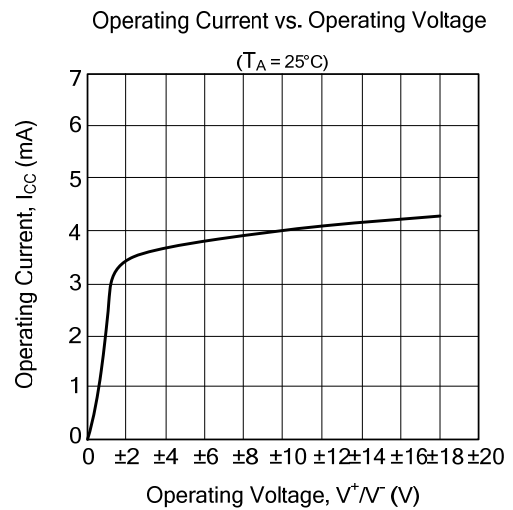
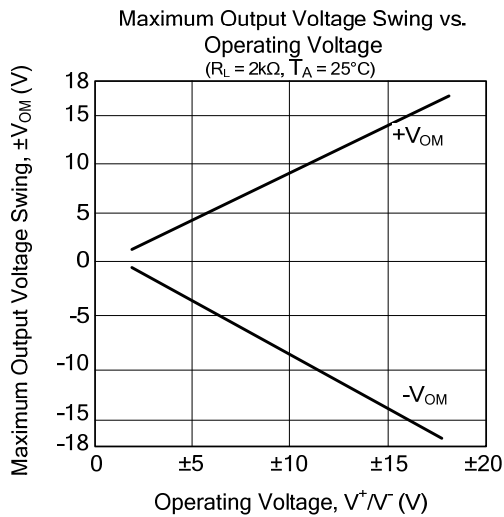
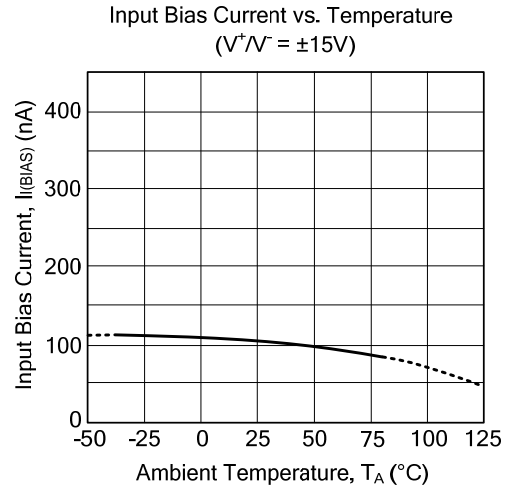
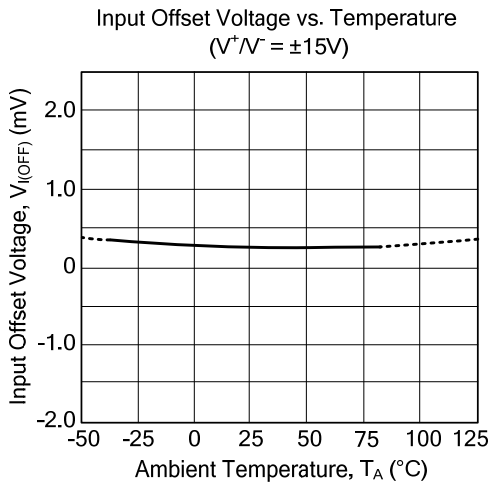

UTC assumes no responsibility for equipment failures that result from using products at values that exceed, even momentarily, rated values (such as maximum ratings, operating condition ranges, or other parameters) listed in products specifications of any and all UTC products described or contained herein. UTC products are not designed for use in life support appliances, devices or systems where malfunction of these products can be reasonably expected to result in personal injury. Reproduction in whole or in part is prohibited without the prior written consent of the copyright owner. The information presented in this document does not form part of any quotation or contract, is believed to be accurate and reliable and may be changed without notice.