



## MPSA06

## NPN SILICON TRANSISTOR

### NPN TRANSISTOR

#### ■ FEATURES

- \* Collector-emitter voltage:  $V_{CE0}=80V$
- \* Collector dissipation:  $P_D=625mW$

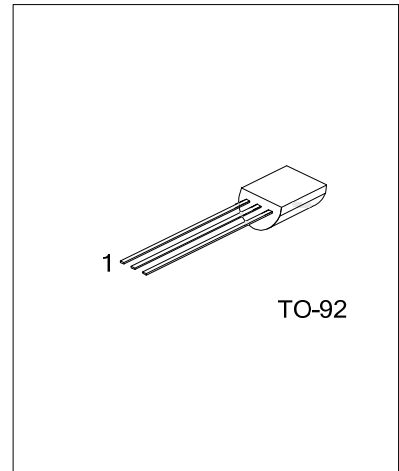

#### ■ ORDERING INFORMATION

Ordering Number		Package	Pin Assignment			Packing
Lead Free	Halogen Free		1	2	3	
MPSA06L-T92-B	MPSA06G-T92-B	TO-92	E	B	C	Tape Box
MPSA06L-T92-K	MPSA06G-T92-K	TO-92	E	B	C	Bulk

<p>MPSA06G-T92-B</p> <ul style="list-style-type: none"> <li>(1) Packing Type</li> <li>(2) Package Type</li> <li>(3) Green Package</li> </ul>	<ul style="list-style-type: none"> <li>(1) B: Tape Box, K: Bulk</li> <li>(2) T92: TO-92</li> <li>(3) G: Halogen Free and Lead Free, L: Lead Free</li> </ul>
--	---

#### ■ MARKING

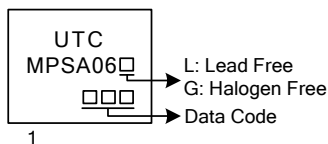

1



■ ABSOLUTE MAXIMUM RATING ( $T_A=25^{\circ}\text{C}$ , unless otherwise specified)

PARAMETER	SYMBOL	RATINGS	UNIT
Collector-Base Voltage	$V_{CBO}$	80	V
Collector-Emitter Voltage	$V_{CEO}$	80	V
Emitter-Base Voltage	$V_{EBO}$	4	V
Collector Current - Continuous	$I_C$	500	mA
Total device Dissipation, @ $T_A=25^{\circ}\text{C}$ Derate above $25^{\circ}\text{C}$	$P_D$	625 5	mW mW/ $^{\circ}\text{C}$
Total device Dissipation, @ $T_C=25^{\circ}\text{C}$ Derate above $25^{\circ}\text{C}$	$P_D$	1500 12	mW mW/ $^{\circ}\text{C}$
Junction Temperature	$T_J$	+125	$^{\circ}\text{C}$
Storage Temperature	$T_{STG}$	-55 ~ +150	$^{\circ}\text{C}$

Note: Absolute maximum ratings are those values beyond which the device could be permanently damaged.  
Absolute maximum ratings are stress ratings only and functional device operation is not implied.

■ THERMAL CHARACTERISTICS

PARAMETER	SYMBOL	RATINGS	UNIT
Junction-to-Ambient	$\theta_{JA}$	200	$^{\circ}\text{C}/\text{W}$
Junction-to-Case	$\theta_{JC}$	83.3	$^{\circ}\text{C}/\text{W}$

■ ELECTRICAL CHARACTERISTICS ( $T_a=25^{\circ}\text{C}$ , unless otherwise specified)

PARAMETER	SYMBOL	TEST CONDITIONS	MIN	TYP	MAX	UNIT
<b>OFF CHARACTERISTICS</b>						
Collector-Emitter Breakdown Voltage (Note 1)	$BV_{CEO}$	$I_C=1.0\text{mA}$ , $I_B=0$	80			V
Emitter-Base Breakdown Voltage	$BV_{EBO}$	$I_E=100\mu\text{A}$ , $I_C=0$	4			V
Collector Cutoff Current	$I_{CEO}$	$V_{CE}=60\text{V}$ , $I_B=0$			0.1	$\mu\text{A}$
Collector Cutoff Current	$I_{CBO}$	$V_{CB}=80\text{V}$ , $I_E=0$			0.1	$\mu\text{A}$
<b>ON CHARACTERISTICS</b>						
Dc Current Gain	$h_{FE}$	$I_C=10\text{mA}$ , $V_{CE}=1\text{V}$	100			
		$I_C=100\text{mA}$ , $V_{CE}=1\text{V}$	100			
Collector-Emitter Saturation Voltage	$V_{CE(SAT)}$	$I_C=100\text{mA}$ , $I_B=10\text{mA}$			0.25	V
Base-Emitter On Voltage	$V_{BE(ON)}$	$I_C=100\text{mA}$ , $V_{CE}=1\text{V}$			1.2	V
<b>SMALL-SIGNAL CHARACTERISTICS</b>						
Current Gain Bandwidth Product (Note 2)	$f_T$	$I_C=10\text{mA}$ , $V_{CE}=2\text{V}$ , $f=100\text{MHz}$	100			MHz

Notes: 1. Pulse test:  $P_W \leq 300\mu\text{s}$ , Duty Cycle  $\leq 2\%$ .

2.  $f_T$  is defined as the frequency at which  $|h_{fe}|$  extrapolates to unity.

## TYPICAL CHARACTERISTICS

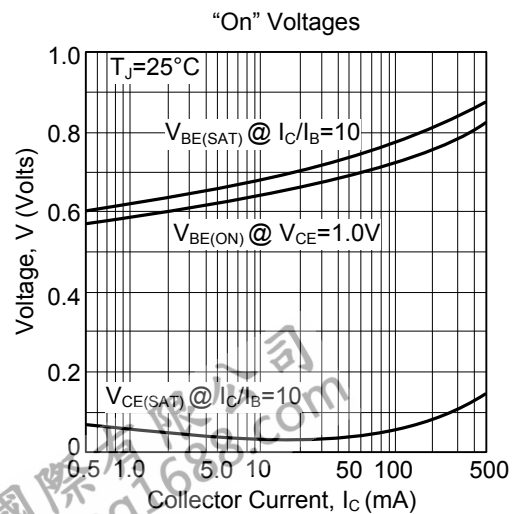
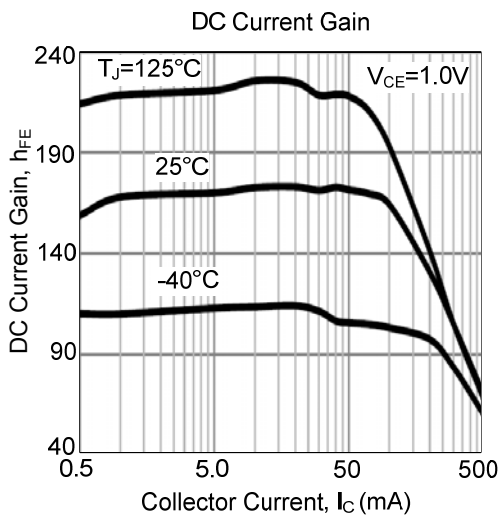
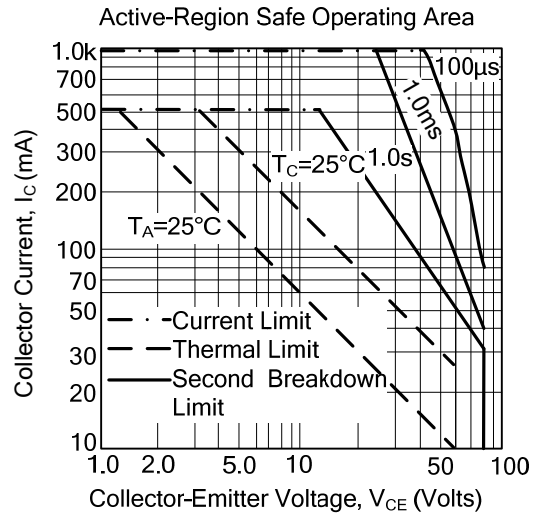
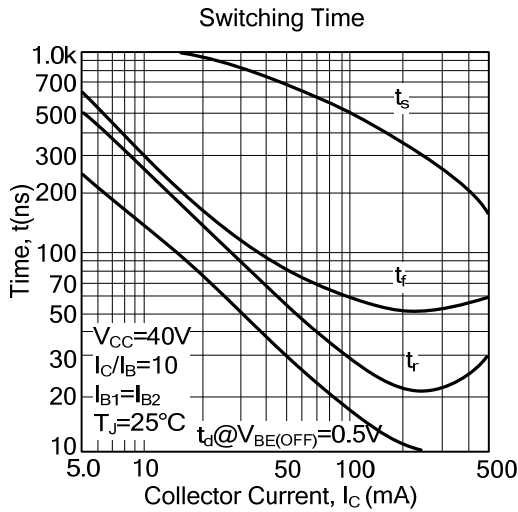
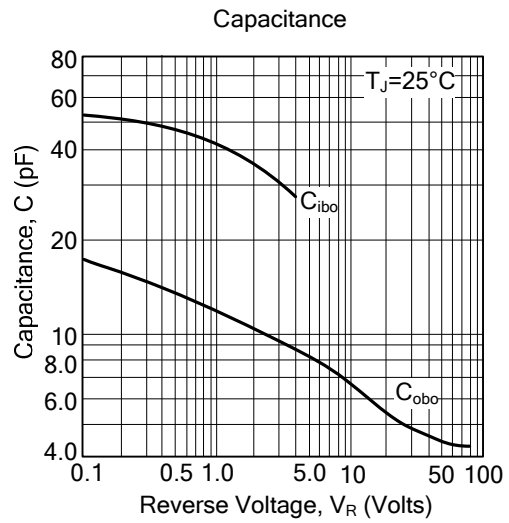
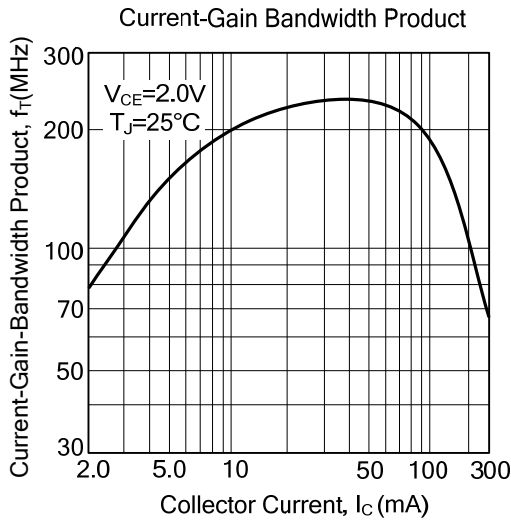

■ TYPICAL CHARACTERISTICS(Cont.)

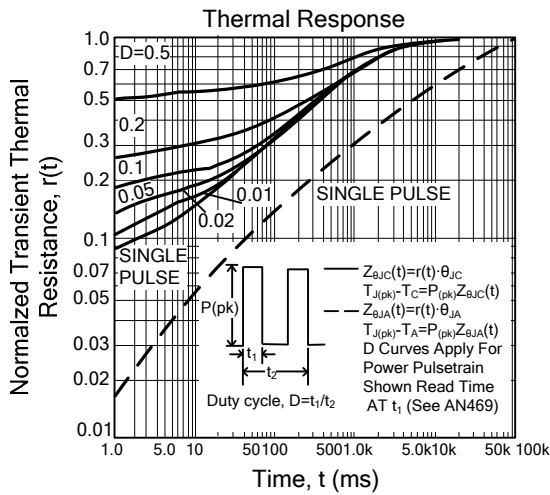
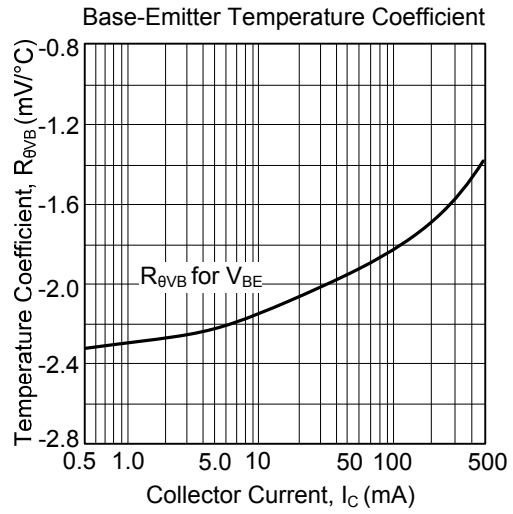
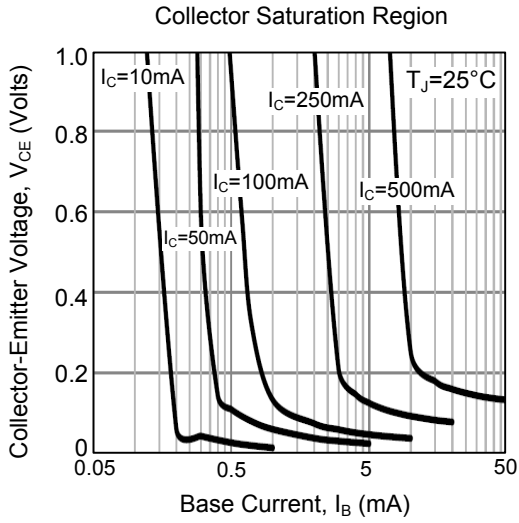

UTC assumes no responsibility for equipment failures that result from using products at values that exceed, even momentarily, rated values (such as maximum ratings, operating condition ranges, or other parameters) listed in products specifications of any and all UTC products described or contained herein. UTC products are not designed for use in life support appliances, devices or systems where malfunction of these products can be reasonably expected to result in personal injury. Reproduction in whole or in part is prohibited without the prior written consent of the copyright owner. UTC reserves the right to make changes to information published in this document, including without limitation specifications and product descriptions, at any time and without notice. This document supersedes and replaces all information supplied prior to the publication hereof.