



MPSA92/93

PNP SILICON TRANSISTOR

HIGH VOLTAGE PNP TRANSISTOR

DESCRIPTION

The UTC **MPSA92/93** are high voltage PNP transistors, designed for telephone signal switching and for high voltage amplifier.

FEATURES

* High Collector-Emitter voltage:

$V_{CE0} = -300V$ (UTC **MPSA92**)

$V_{CE0} = -200V$ (UTC **MPSA93**)

* Collector Dissipation:

$P_C (max.) = 625mW$

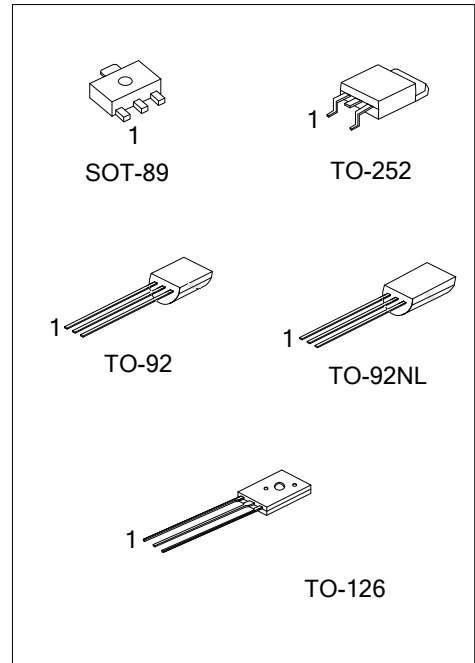

ORDERING INFORMATION

Ordering Number		Package	Pin Assignment			Packing
Lead Free	Halogen Free		1	2	3	
MPSA92L-AB3-R	MPSA92G-AB3-R	SOT-89	B	C	E	Tape Reel
MPSA92L-TN3-R	MPSA92G-TN3-R	TO-252	B	C	E	Tape Reel
MPSA92L-T60-K	MPSA92G-T60-K	TO-126	E	C	B	Bulk
MPSA92L-T92-B	MPSA92G-T92-B	TO-92	E	B	C	Tape Box
MPSA92L-T92-K	MPSA92G-T92-K	TO-92	E	B	C	Bulk
MPSA92L-T9N-B	MPSA92G-T9N-B	TO-92NL	E	C	B	Tape Box
MPSA92L-T9N-K	MPSA92G-T9N-K	TO-92NL	E	C	B	Bulk
MPSA93L-AB3-R	MPSA93G-AB3-R	SOT-89	B	C	E	Tape Reel
MPSA93L-TN3-R	MPSA93G-TN3-R	TO-252	B	C	E	Tape Reel
MPSA93L-T92-B	MPSA93G-T92-B	TO-92	E	B	C	Tape Box
MPSA93L-T92-K	MPSA93G-T92-K	TO-92	E	B	C	Bulk

Note: Pin Assignment: B: Base C: Collector E: Emitter

<p>MPSA92G-AB3-R</p>	<p>(1) B: Tape Box, K: Bulk, R: Tape Reel</p> <p>(2) AB3: SOT-89, TN3: TO-252, T60: TO-126 T92: TO-92, T9N: TO-92NL</p> <p>(3) G: Halogen Free and Lead Free, L: Lead Free</p>
----------------------	--

MARKING

Package	MPSA92	MPSA93
SOT-89	<p> Date Code L: Lead Free G: Halogen Free </p>	<p> Date Code L: Lead Free G: Halogen Free </p>
TO-252	<p> L: Lead Free G: Halogen Free Date Code </p>	<p> L: Lead Free G: Halogen Free Date Code </p>
TO-126	<p> Date Code L: Lead Free G: Halogen Free </p>	-
TO-92	<p> L: Lead Free G: Halogen Free Date Code </p>	<p> L: Lead Free G: Halogen Free Date Code </p>
TO-92NL	<p> L: Lead Free G: Halogen Free Date Code </p>	-

汎翔國際有限公司
 www.flying1688.com

■ ABSOLUTE MAXIMUM RATING (T_A=25°C unless otherwise specified)

PARAMETER		SYMBOL	RATINGS	UNIT
Collector-Base Voltage	MPSA92	V _{CBO}	-300	V
	MPSA93		-200	V
Collector-Emitter Voltage	MPSA92	V _{CEO}	-300	V
	MPSA93		-200	V
Emitter-Base Voltage		V _{EBO}	-5	V
Base Current		I _B	-100	mA
Collector Current		I _C	-500	mA
Collector Dissipation	SOT-89	P _C	0.5	W
	TO-252		1.1	W
	TO-126		1	W
	TO-92/TO-92NL		0.62	W
Junction Temperature		T _J	150	°C
Storage Temperature		T _{STG}	-55~ +150	°C

Note: Absolute maximum ratings are those values beyond which the device could be permanently damaged. Absolute maximum ratings are stress ratings only and functional device operation is not implied.

■ THERMAL CHARACTERISTICS

PARAMETER		SYMBOL	RATINGS	UNIT
Junction to Ambient	SOT-89	θ _{JA}	250	°C/W
	TO-252		110	°C/W
	TO-126		125	°C/W
	TO-92/TO-92NL		200	°C/W
Junction to Case	SOT-89	θ _{JC}	43	°C/W
	TO-252		8.3	°C/W
	TO-126		12.5	°C/W
	TO-92/TO-92NL		83.3	°C/W

■ ELECTRICAL CHARACTERISTICS (T_A=25°C, unless otherwise specified)

PARAMETER		SYMBOL	TEST CONDITIONS	MIN	TYP	MAX	UNIT
OFF CHARACTERISTICS							
Collector-Base Breakdown Voltage	MPSA92	BV _{CBO}	I _C =-100μA, I _E =0	-300			V
	MPSA93			-200			V
Collector-Emitter Breakdown Voltage	MPSA92	BV _{CEO}	I _C =-1mA, I _B =0	-300			V
	MPSA93			-200			V
Emitter-Base Breakdown Voltage		BV _{EBO}	I _E =-100μA, I _C =0	-5			V
Collector Cut-Off Current	MPSA92	I _{CBO}	V _{CB} =-200V, I _E =0			-0.25	μA
	MPSA93					-0.25	μA
Emitter Cut-Off Current		I _{EBO}	V _{EB} =-3V, I _C =0			-0.10	μA
ON CHARACTERISTICS							
DC Current Gain(note)	h _{FE}		V _{CE} =-10V, I _C =-1mA	60			
			V _{CE} =-10V, I _C =-10mA	80			
			V _{CE} =-10V, I _C =-30mA	80			
Collector-Emitter Saturation Voltage		V _{CE(SAT)}	I _C =-20mA, I _B =-2mA			-0.5	V
Base-Emitter Saturation Voltage		V _{BE(SAT)}	I _C =-20mA, I _B =-2mA			-0.90	V
SMALL SIGNAL CHARACTERISTICS							
Current Gain Bandwidth Product		f _T	V _{CE} =-20V, I _C =-10mA, f=100MHz	50			MHz
Output Capacitance	MPSA92	C _{ob}	V _{OB} =-20V, I _E =0, f=1MHz			6	pF
	MPSA93					8	pF

Note: Pulse test: P_W<300μs, Duty Cycle<2%, V_{CE(SAT)}<200mV

TYPICAL CHARACTERISTICS

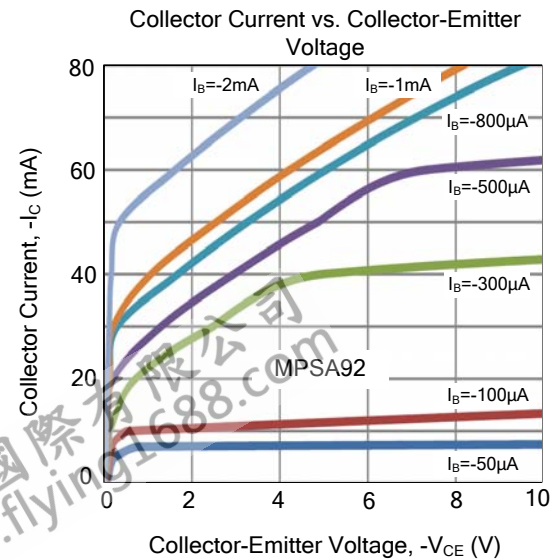
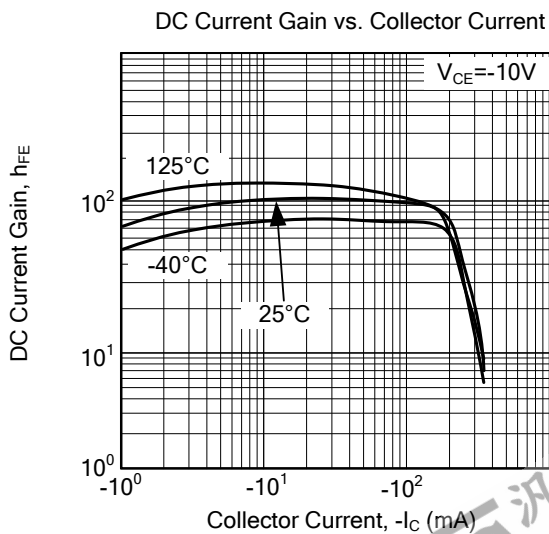
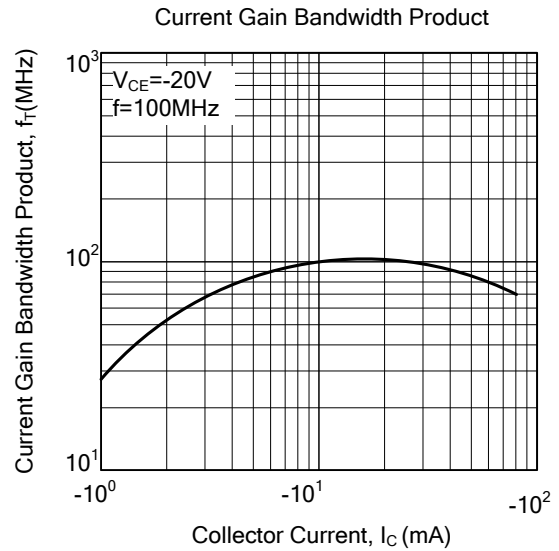
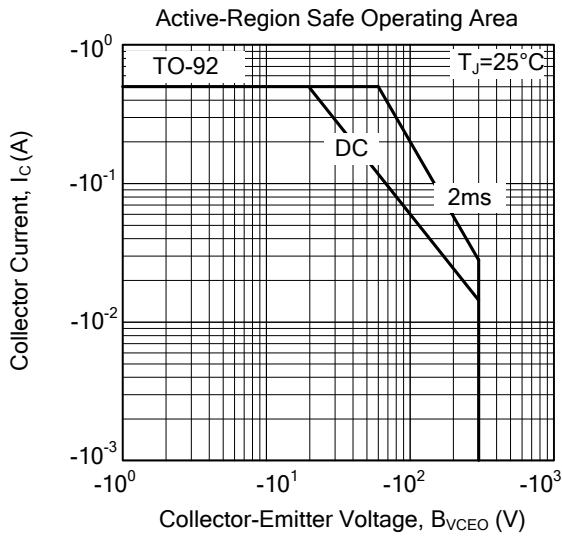
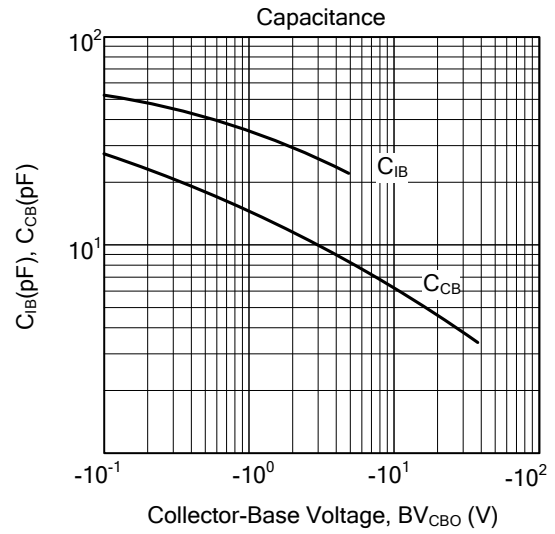
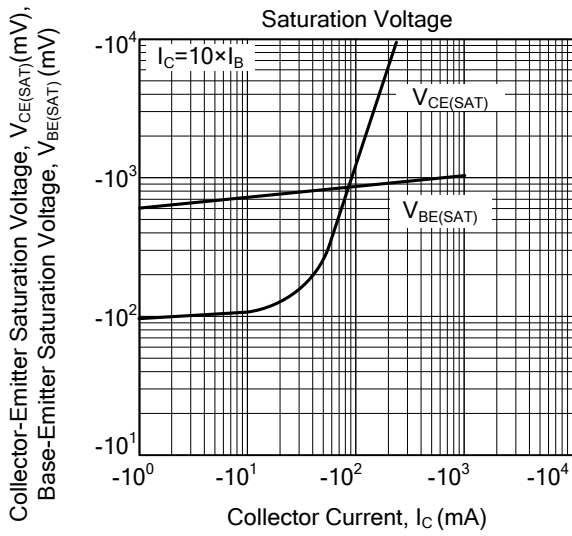

■ TYPICAL CHARACTERISTICS (Cont.)

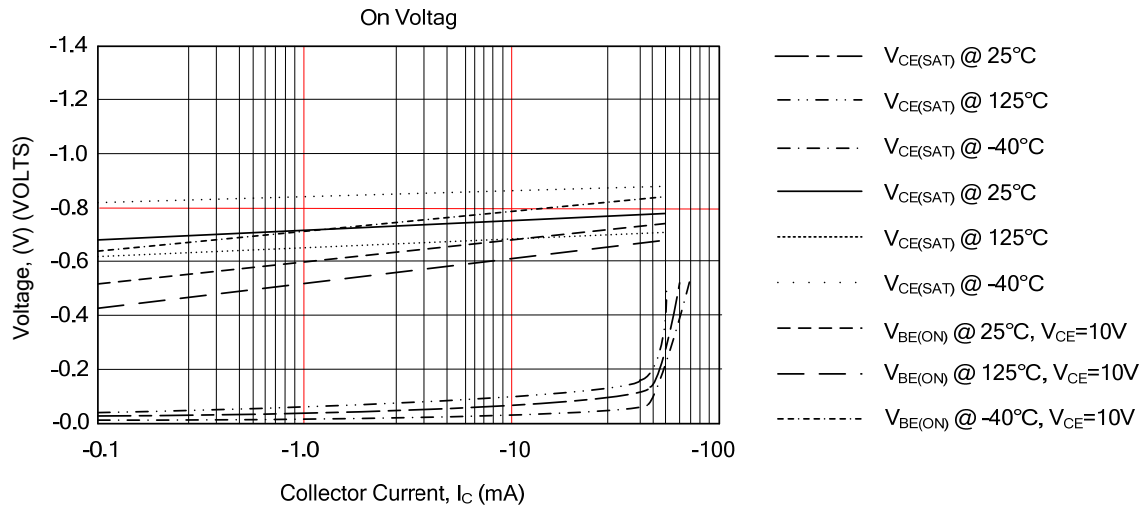

UTC assumes no responsibility for equipment failures that result from using products at values that exceed, even momentarily, rated values (such as maximum ratings, operating condition ranges, or other parameters) listed in products specifications of any and all UTC products described or contained herein. UTC products are not designed for use in life support appliances, devices or systems where malfunction of these products can be reasonably expected to result in personal injury. Reproduction in whole or in part is prohibited without the prior written consent of the copyright owner. UTC reserves the right to make changes to information published in this document, including without limitation specifications and product descriptions, at any time and without notice. This document supersedes and replaces all information supplied prior to the publication hereof.