



PA1517

LINEAR INTEGRATED CIRCUIT

2 × 6 W STEREO POWER AMPLIFIER

DESCRIPTION

The UTC **PA1517** is an integrated class-B dual output amplifier. It is mainly using for multi-media applications.

FEATURES

- * Needs very few external components
- * High output power
- * Fixed gain
- * Very good ripple rejection
- * Mute/standby switch
- * AC and DC short-circuit safe to ground and V_{CC}
- * Thermally protected
- * Reverse polarity safe
- * Can handle high energy on outputs ($V_{CC} = 0V$)
- * Have no switch-on/switch-off plop
- * Electrostatic discharge protection.

ORDERING INFORMATION

Ordering Number		Package	Packing
Lead Free	Halogen Free		
PA1517L-H09-B-T	PA1517G-H09-B-T	HSIP-9B	Tube
-	PA1517G-D18-T	DIP-18	Tube
PA1517L-D20-T	PA1517G-D20-T	DIP-20	Tube

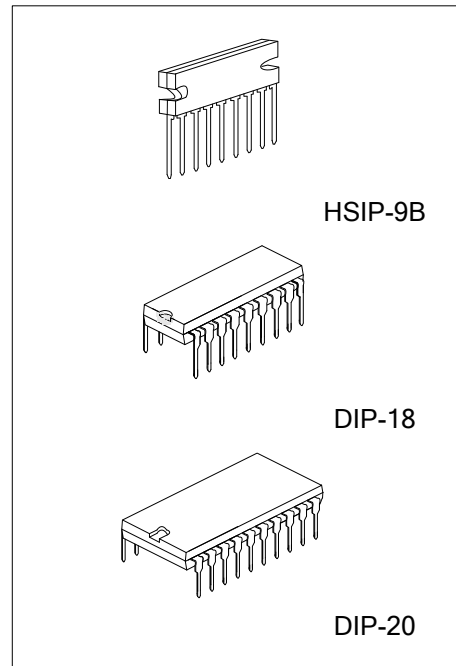

	(1)Packing Type	(1) T: Tube
	(2)Package Type	(2) H09-B: HISP-9B, D18: DIP-18, D20: DIP-20
	(3)Green Package	(3) L: Lead Free, G: Halogen Free and Lead Free



PA1517

LINEAR INTEGRATED CIRCUIT

MARKING

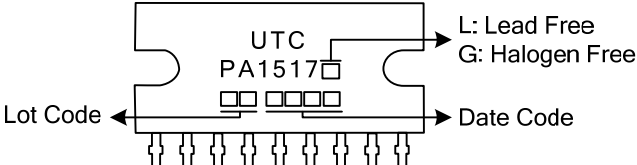
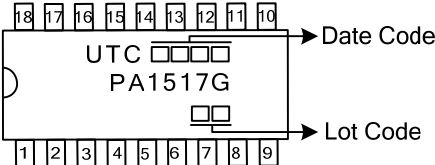
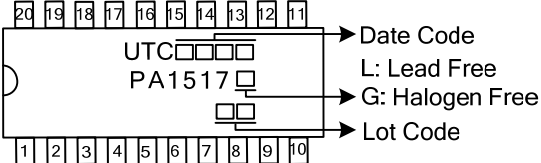
PACKAGE	MARKING
HSIP-9B	 <p>UTC PA1517</p> <p>Lot Code ←</p> <p>→ Date Code</p> <p>→ L: Lead Free → G: Halogen Free</p>
DIP-18	 <p>18 17 16 15 14 13 12 11 10 → Date Code</p> <p>UTC □□□□</p> <p>PA1517G</p> <p>□□ → Lot Code</p> <p>1 2 3 4 5 6 7 8 9</p>
DIP-20	 <p>20 19 18 17 16 15 14 13 12 11 → Date Code</p> <p>UTC □□□□</p> <p>PA1517</p> <p>□□ → Lot Code</p> <p>→ L: Lead Free → G: Halogen Free</p> <p>1 2 3 4 5 6 7 8 9 10</p>

FLYING 汎翔國際有限公司
www.flying1688.com

■ PIN CONFIGURATION

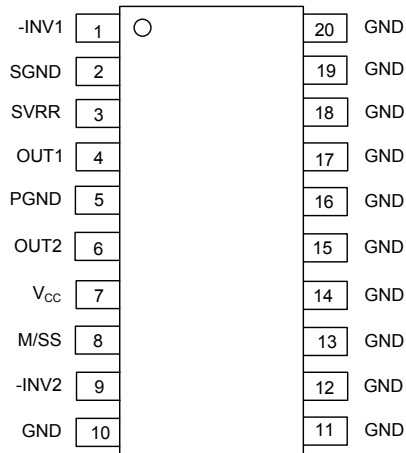

DIP-20

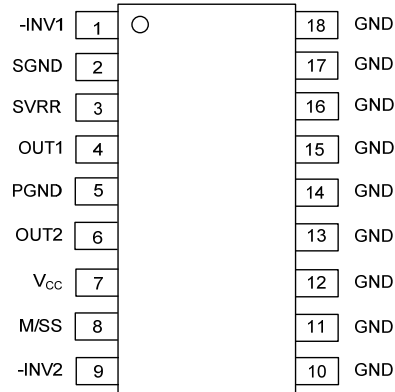

DIP-18

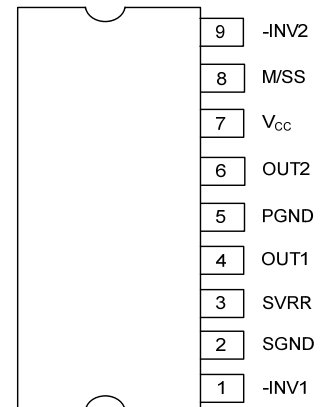

HSIP-9B

■ PIN DESCRIPTIONS

PIN NO.	PIN NAME	PIN FUNCTION
1	-INV1	Non-inverting input 1
2	SGND	Signal ground
3	SVRR	Output of supply voltage ripple rejection
4	OUT1	Output 1
5	PGND	Power ground
6	OUT2	Output 2
7	V _{CC}	Supply voltage input
8	M/SS	Input of mute/standby switch
9	-INV2	Non-inverting input 2
10	GND	GND
11	GND	GND
12	GND	GND
13	GND	GND
14	GND	GND
15	GND	GND
16	GND	GND
17	GND	GND
18	GND	GND
19	GND	GND
20	GND	GND

■ BLOCK DIAGRAM

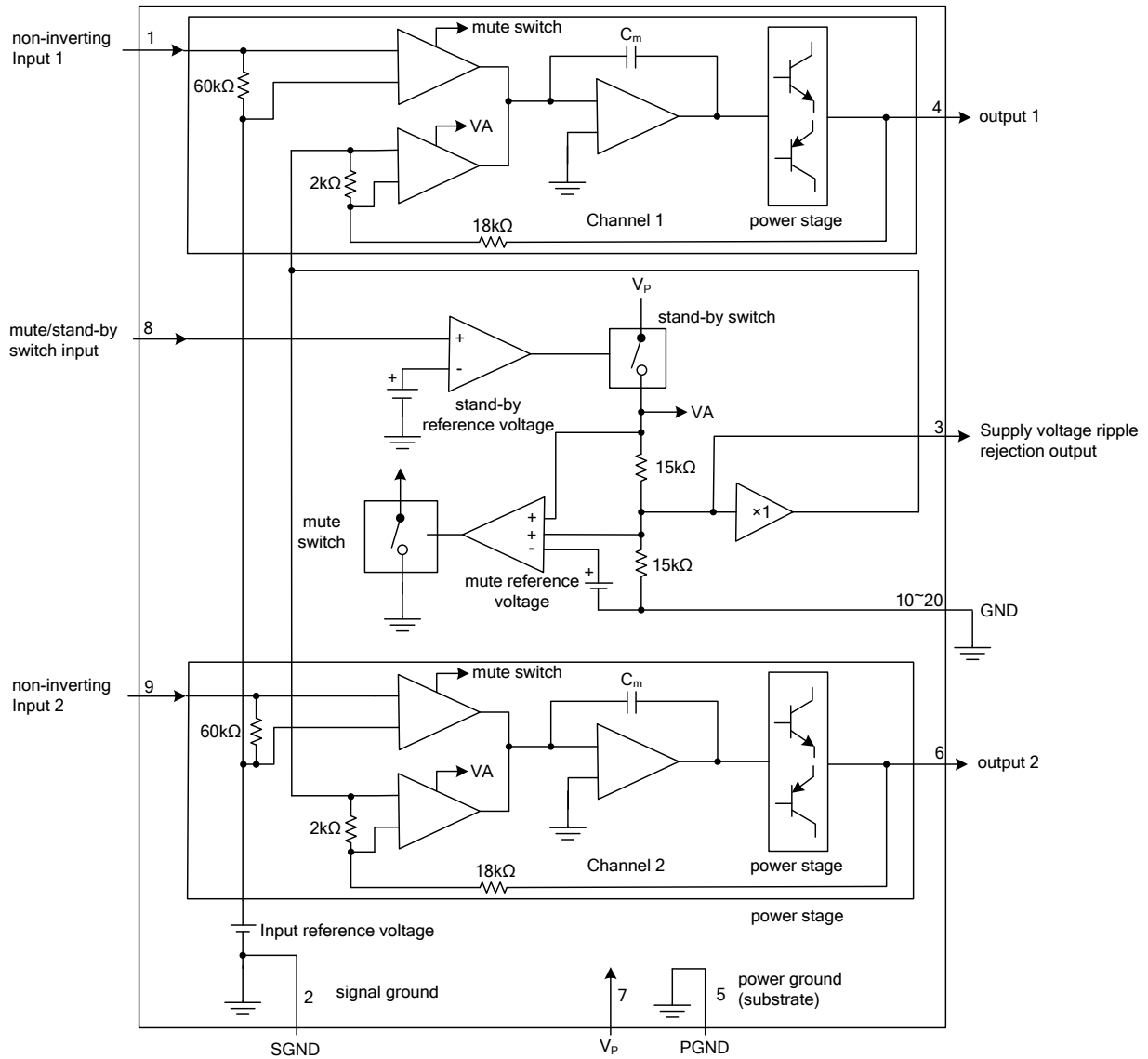

■ ABSOLUTE MAXIMUM RATINGS

PARAMETER		SYMBOL	RATINGS	UNIT
Supply Voltage	Operating	V_{CC}	18	V
	No Signal		20	V
AC and DC Short-Circuit Safe Voltage		$V_{CC(SC)}$	18	V
Reverse Polarity		$V_{CC(R)}$	6	V
Energy Handling Capability at Outputs ($V_{CC} = 0V$)		ERG_O	200	mJ
Peak Output Current	Non-Repetitive	I_{OSM}	4	A
	Repetitive		2.5	A
Power Dissipation ($T_a = 25^\circ C$)	DIP-18/HSIP-9B	P_D	2.5	W
	DIP-20		2.85	W
Junction Temperature		T_J	150	$^\circ C$
Operating Temperature		T_{OPR}	-40 ~ +85	$^\circ C$
Storage Temperature		T_{STG}	-55 ~ +150	$^\circ C$

Note: Absolute maximum ratings are those values beyond which the device could be permanently damaged. Absolute maximum ratings are stress ratings only and functional device operation is not implied.

■ THERMAL DATA

PARAMETER		SYMBOL	MIN	TYP	MAX	UNIT
Junction to Ambient	DIP-18/HSIP-9B	θ_{JA}		50		$^\circ C/W$
	DIP-20			43.9		$^\circ C/W$

■ RECOMMENDED OPERATING CONDITIONS

PARAMETER	SYMBOL	TEST CONDITIONS	MIN	TYP	MAX	UNIT
Supply Voltage	V_{CC}		6.0	14.4	18.0	V
Repetitive Peak Output Current	I_{ORM}				2.5	A
Total Quiescent Current	I_Q			40	80	mA
Standby Current	I_{SB}			0.1	100	μA
Switch-on Current	I_{SW}				40	μA
Input Impedance	$ Z_i $		50			k Ω
Output Power	P_{OUT}	$R_L = 4 \Omega$; THD = 0.5%		5		W
		$R_L = 4 \Omega$; THD = 10%		6		W
Supply Voltage Ripple Rejection	SVRR	$f_i = 100 \text{ Hz to } 10 \text{ kHz}$	48			dB
Channel Separation	α_{CS}		40			dB
Closed Loop Voltage Gain	G_V		19	20	21	dB
Noise Output Voltage (RMS Value)	$V_{NO(RMS)}$			50		μV

■ ELECTRICAL CHARACTERISTICS ($T_a = 25^\circ C$; unless otherwise specified)

PARAMETER	SYMBOL	TEST CONDITIONS	MIN	TYP	MAX	UNIT
DC ELECTRICAL CHARACTERISTICS ($V_{CC} = 14.4 \text{ V}$)						
SUPPLY						
Supply Voltage	V_{CC}	Note 1	6.0	14.4	18.0	V
Total Quiescent Current	$I_{Q(TOT)}$			40	80	mA
DC Output Voltage	V_{OUT}			6.95		V
MUTE/STAND-BY SWITCH						
Switch-on Voltage Level	V_8		8.5			V
MUTE CONDITION						
Output Signal in Mute Position	V_{OUT}	$V_{I(MAX)} = 1V$; $f_i = 20 \text{ Hz to } 15 \text{ kHz}$			2	mV
STAND-BY CONDITION						
DC Current in Standby Condition	I_{SB}				100	μA
Switch-on Current	I_{SW}			12	40	μA

■ ELECTRICAL CHARACTERISTICS

PARAMETER		SYMBOL	TEST CONDITIONS	MIN	TYP	MAX	UNIT
AC ELECTRICAL CHARACTERISTICS ($V_{CC} = 14.4\text{ V}$; $R_L = 4\Omega$; $f = 1\text{ kHz}$)							
Output Power		P_{OUT}	THD = 0.5%; Note 1	4	5		W
			THD = 10%; Note 1	5.5	6.0		W
Total Harmonic Distortion		THD	$P_{OUT} = 1\text{ W}$		0.1		%
Low Frequency Roll-Off		f_{LR}	at -3 dB; Note 2		45		Hz
High Frequency Roll-Off		f_{HR}	at -1dB	20			kHz
Closed Loop Voltage Gain		G_V	Untrimmed	19	20	21	
Supply Voltage Ripple Rejection	On	SVRR	Note 3	48			dB
	Mute			48			dB
	Stand-by			80			dB
Input Impedance		$ Z_{IN} $		50	60	75	$\text{k}\Omega$
Noise Output Voltage	On	V_{NO}	$R_S = 0\Omega$; Note 4		50		μV
	On		$R_S = 10\Omega$; Note 4		70	100	μV
	Mute		Note 5		50		μV
Channel Separation		α_{CS}	$R_S = 10\Omega$	40			dB
Channel Unbalance		$ \Delta G_V $			0.1	1	dB

Notes: 1. Output power is measured at the output pins of the IC.

2. Frequency response externally fixed.

3. Ripple rejection measured at the output with a source impedance of 0Ω , maximum ripple amplitude of 2 V(p-p) and a frequency between 100 Hz and 10 kHz.

4. Noise voltage measured in a bandwidth of 20 Hz to 20 kHz.

5. Noise output voltage independent of R_S ($V_{IN} = 0\text{ V}$).

■ TYPICAL APPLICATION

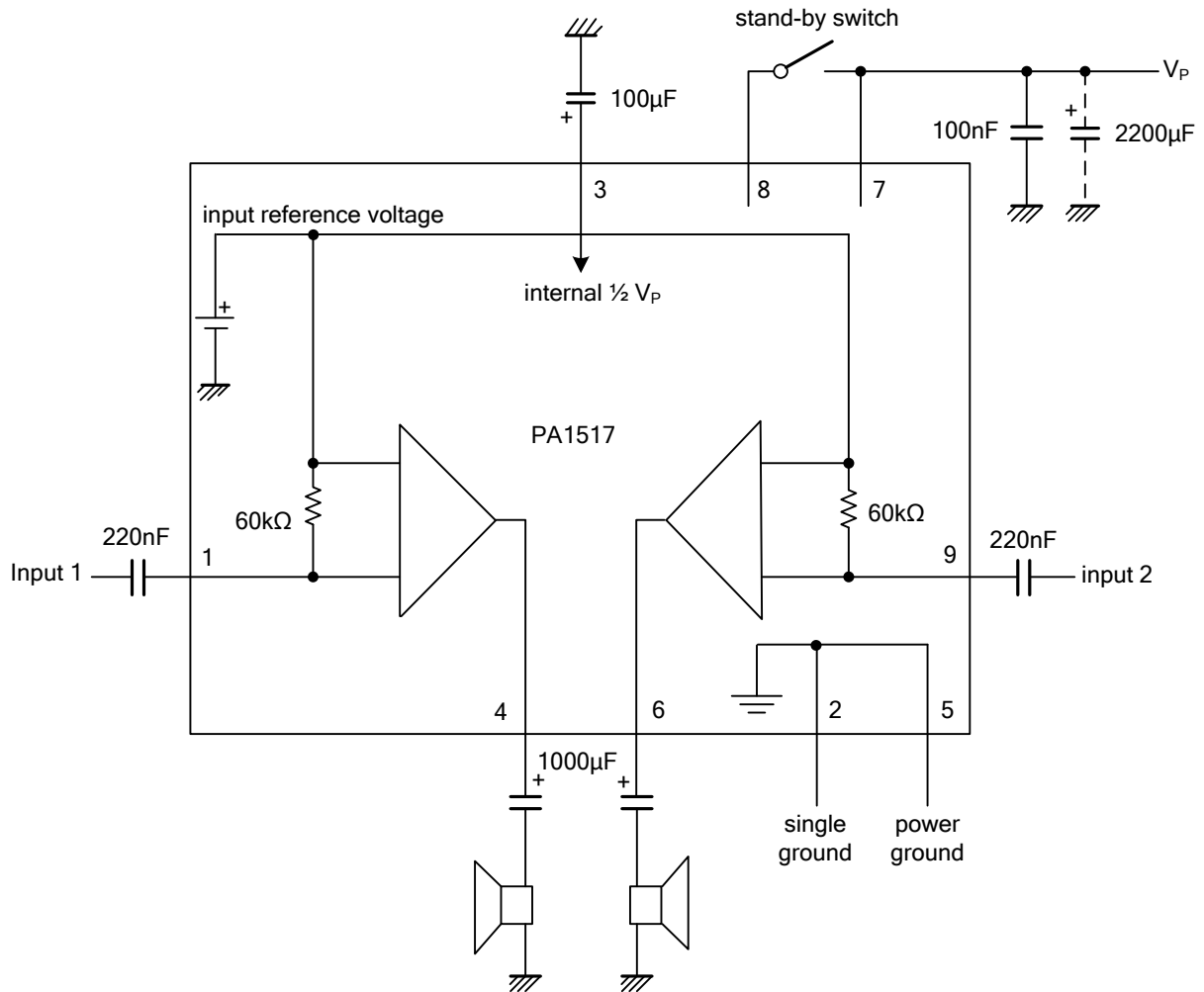

■ TYPICAL APPLICATION

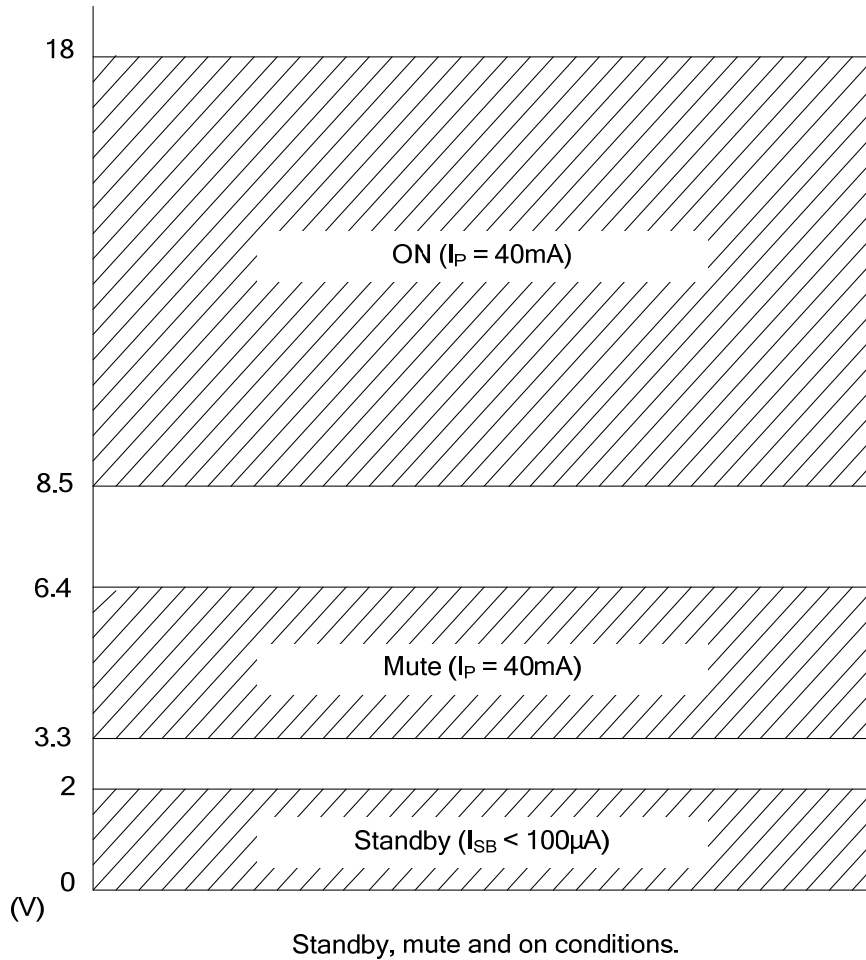

FLYING 汎翔國際有限公司
www.flying1688.com

TYPICAL CHARACTERISTICS

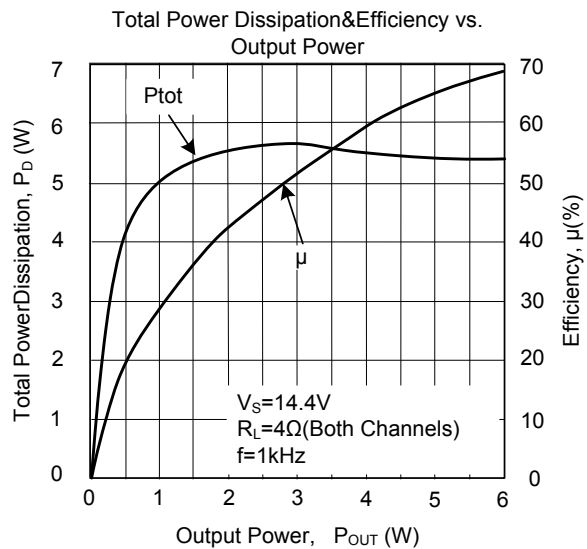
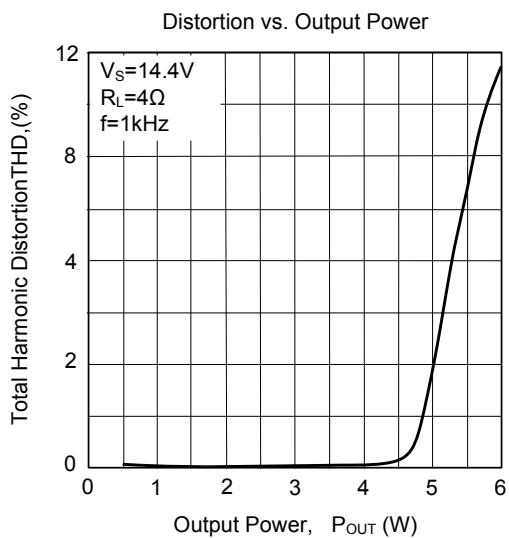
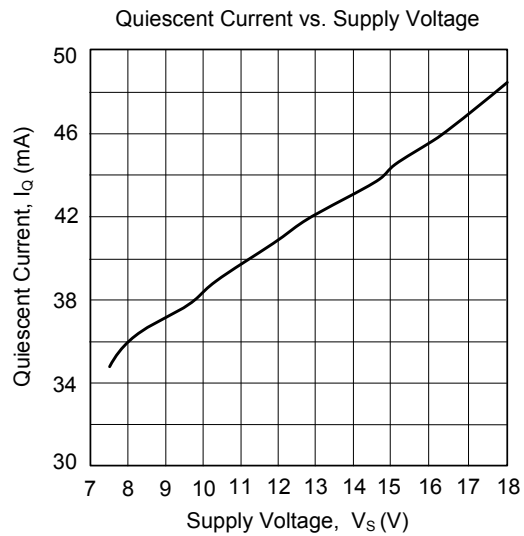
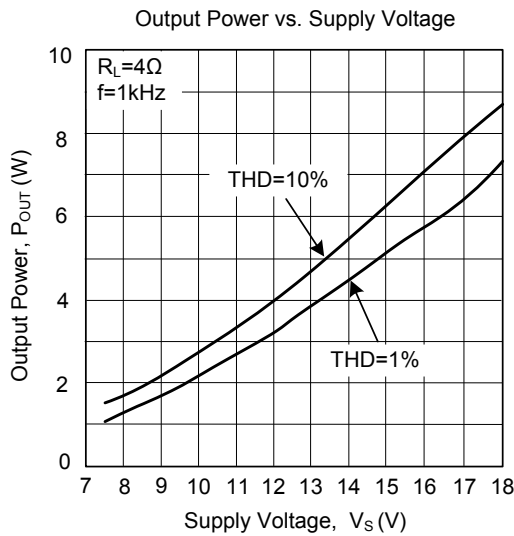

UTC assumes no responsibility for equipment failures that result from using products at values that exceed, even momentarily, rated values (such as maximum ratings, operating condition ranges, or other parameters) listed in products specifications of any and all UTC products described or contained herein. UTC products are not designed for use in life support appliances, devices or systems where malfunction of these products can be reasonably expected to result in personal injury. Reproduction in whole or in part is prohibited without the prior written consent of the copyright owner. The information presented in this document does not form part of any quotation or contract, is believed to be accurate and reliable and may be changed without notice.