



PA3112

CMOS IC

DUAL 150mW AUDIO POWER AMPLIFIER

DESCRIPTION

The UTC **PA3112** is a dual audio power amplifier with differential inputs capable of delivering typically 150mW per channel of continuous average power to an 16Ω load with less than 0.1% THD+N using a 5V power supply. The unity-gain stable UTC **PA3112** can be configured by external gain-setting resistors.

The UTC **PA3112** features an externally controlled, low-power consumption shutdown mode. The UTC **PA3112** exhibit a low quiescent current of typically 1.5mA, allowing usage in portable applications.

FEATURES

- * Operating voltage range $V_{DD}=2.5V\sim 5.5V$
- * Output power:
-150mW @5V into 16Ω
- * Differential inputs
- * Shutdown mode available
- * Low current consumption:3mA max
- * click and pop reduction circuitry
- * Unity-gain stable
- * Thermal and over-current protection

ORDERING INFORMATION

Ordering Number			Package	Packing
Normal	Lead Free	Halogen Free		
PA3112-SM2-R	PA3112L-SM2-R	PA3112G-SM2-R	MSOP-10	Tape Reel
PA3112-SM2-T	PA3112L-SM2-T	PA3112G-SM2-T	MSOP-10	Tube

<p>PA3112L-SM2-R</p> <p>(1)Packing Type (2)Package Type (3)Lead Plating</p>	<p>(1) R: Tape Reel, T: Tube (2) SM2: MSOP-10 (3) G: Halogen Free, L: Lead Free, Blank: Pb/Sn</p>
---	---

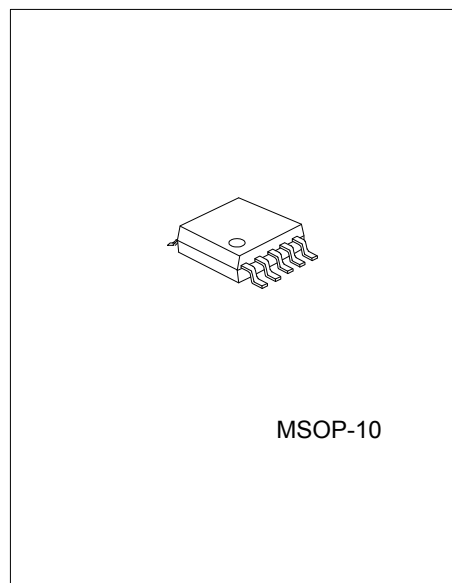

Lead-free: PA3112L
Halogen-free: PA3112G



■ PIN CONFIGURATION

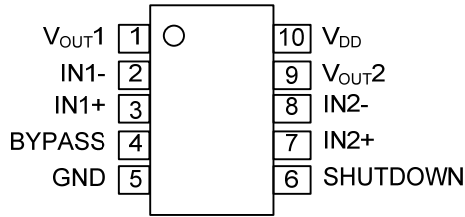

■ PIN DESCRIPTION

PIN NO	PIN NAME	I/O	DESCRIPTION
4	BYPASS	I	Connect to internal voltage divider. For best performance, a 0.1 μ F ~ 1 μ F low ESR capacitor used.
5	GND	I	Ground
2	IN1-	I	Channel 1 negative input.
3	IN1+	I	Channel 1 positive input.
8	IN2-	I	Channel 2 negative input.
7	IN2+	I	Channel 2 positive input.
6	SHUTDOWN	I	Low quiescent current mode enable. High active.
10	V _{DD}	I	Supply voltage.
1	V _{OUT1}	O	Channel 1 audio output.
9	V _{OUT2}	O	Channel 2 audio output.

FLYING 汎翔國際有限公司
www.flying1688.com

■ ABSOLUTE MAXIMUM RATINGS

PARAMETER	SYMBOL	RATINGS	UNIT
Supply Voltage	V_{DD}	6	V
Input Voltage	V_{IN}	$-0.3 \sim V_{DD} \sim +0.3$	V
Continuous Total Power Dissipation		internally limited	
Operating Junction Temperature	T_J	$-40 \sim +150$	$^{\circ}\text{C}$
Storage Temperature	T_{STG}	$-65 \sim +150$	$^{\circ}\text{C}$

Note: Absolute maximum ratings are those values beyond which the device could be permanently damaged. Absolute maximum ratings are stress ratings only and functional device operation is not implied.

■ RECOMMENDED OPERATING CONDITIONS

PARAMETER	SYMBOL	MIN	TYP	MAX	UNIT
Supply Voltage	V_{DD}	2.5		5.5	V
High-level Input Voltage	V_{IH} , (SHUTDOWN)	$0.6 \times V_{DD}$			V
Low-level Input Voltage	V_{IL} , (SHUTDOWN)			$0.25 \times V_{DD}$	V

■ ELECTRICAL CHARACTERISTICS ($T_A = 25^{\circ}\text{C}$)

PARAMETER	SYMBOL	TEST CONDITIONS	MIN	TYP	MAX	UNIT
DC ELECTRICAL CHARACTERISTICS						
Output Offset Voltage	$V_{O(OFF)}$	$A_V = 2 \text{ V/V}$,			15	mV
Power Supply Rejection Ratio	PSRR	$V_{DD} = 3.2 \text{ V} \sim 3.4 \text{ V}$		83		dB
		$V_{DD} = 4.9 \text{ V} \sim 5.1 \text{ V}$		76		
Supply Current	I_{DD}	SHUTDOWN = 0 V, $V_{DD} = 2.5 \sim 5.5 \text{ V}$		1.5	3	mA
Supply Current in SHUTDOWN Mode	$I_{DD(SD)}$	SHUTDOWN = V_{DD}		10	50	μA
Input Impedance	Z_{IN}	$V_{DD} = 2.5 \sim 5.5 \text{ V}$		>1		M Ω
AC OPERATING CHARACTERISTICS ($V_{DD} = 3.3\text{V}$, $R_L = 16\Omega$)						
Output Power (Each Channel)	P_{OUT}	THD $\leq 0.1\%$, $f = 1 \text{ kHz}$		60		mW
Total Harmonic Distortion + Noise	THD+N	$P_{OUT} = 40 \text{ mW}$, 20 - 20 kHz		0.4%		
Maximum Output Power BW	B_{OM}	$G = 10$, THD < 5%		>20		KHz
Phase Margin		Open loop		96°		
Supply Ripple Rejection Ratio	RR	$f = 1 \text{ kHz}$		71		dB
Channel/Channel Output Separation		$f = 1 \text{ kHz}$		89		dB
Signal-to-Noise Ratio	SNR	$P_{OUT} = 50 \text{ mW}$, $A_V = 1$		100		dB
Noise Output Voltage	eN	$A_V = 1$		11		$\mu\text{V(rms)}$
AC OPERATING CHARACTERISTICS ($V_{DD} = 5\text{V}$, $R_L = 16\Omega$)						
Output Power (each channel)	P_{OUT}	THD $\leq 0.1\%$, $f = 1 \text{ kHz}$		150		mW
Total Harmonic Distortion + Noise	THD+N	$P_{OUT} = 100 \text{ mW}$, 20 - 20 kHz		0.6%		
Maximum Output Power BW	B_{OM}	$G = 10$, THD < 5%		>20		KHz
Phase Margin		Open loop		96°		
Supply Ripple Rejection Ratio	RR	$f = 1 \text{ kHz}$		61		dB
Channel/Channel Output Separation		$f = 1 \text{ kHz}$		90		dB
Signal-to-Noise Ratio	SNR	$P_{OUT} = 100 \text{ mW}$, $A_V = 1$		100		dB
Noise Output Voltage	eN	$A_V = 1$		11.7		$\mu\text{V(rms)}$

■ ELECTRICAL CHARACTERISTICS(Cont.)

PARAMETER	SYMBOL	TEST CONDITIONS	MIN	TYP	MAX	UNIT
AC OPERATING CHARACTERISTICS ($V_{DD} = 3.3V$, $R_L = 32\Omega$)						
Output Power (Each Channel)	P_{OUT}	THD \leq 0.1%, f = 1 kHz		40		mW
Total Harmonic Distortion + Noise	THD+N	$P_{OUT} = 30$ mW, 20 - 20 kHz		0.4%		
Maximum Output Power BW	B_{OM}	$A_V = 10$, THD < 2%		>20		KHz
Phase Margin		Open loop		96°		
Supply Ripple Rejection Ratio	RR	f = 1 kHz		71		dB
Channel/Channel Output Separation		f = 1 kHz		95		dB
Signal-to-Noise Ratio	SNR	$P_{OUT} = 40$ mW, $A_V = 1$		100		dB
Noise Output Voltage	eN	$A_V = 1$		11		μ V(rms)
AC OPERATING CHARACTERISTICS ($V_{DD} = 5V$, $R_L = 32\Omega$)						
Output Power (Each Channel)	P_{OUT}	THD \leq 0.1%, f = 1 kHz		90		mW
Total Harmonic Distortion + Noise	THD+N	$P_{OUT} = 60$ mW, 20 - 20 kHz		0.4%		
Maximum Output Power BW	B_{OM}	$A_V = 10$, THD < 2%		>20		KHz
Phase Margin		Open loop		97°		
Supply Ripple Rejection Ratio	RR	f = 1 kHz		61		dB
Channel/Channel Output Separation		f = 1 kHz		98		dB
Signal-to-Noise Ratio	SNR	$P_{OUT} = 90$ mW, $A_V = 1$		100		dB
Noise Output Voltage	eN	$A_V = 1$		11.7		μ V(rms)

■ TYPICAL APPLICATION CIRCUIT

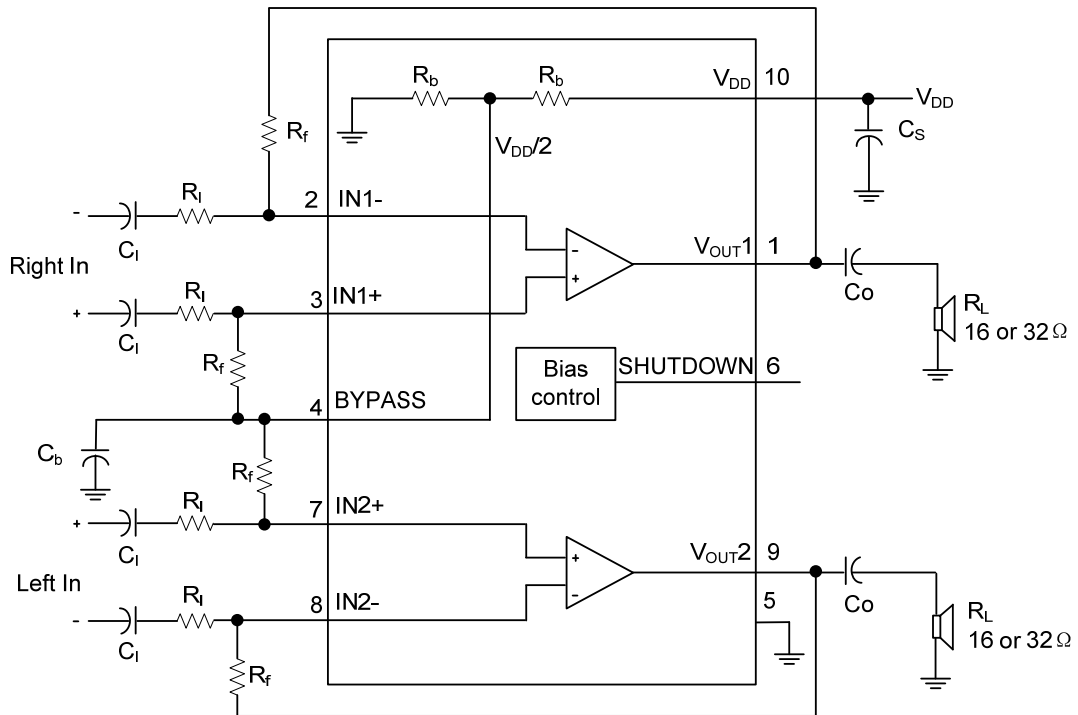

FLYING 汎翔國際有限公司
www.flying1688.com

■ TYPICAL CHARACTERISTICS

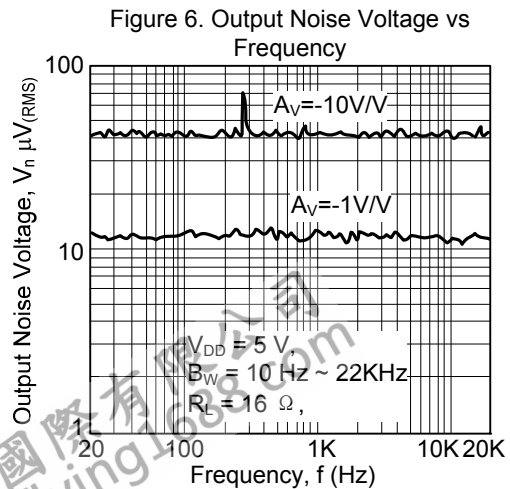
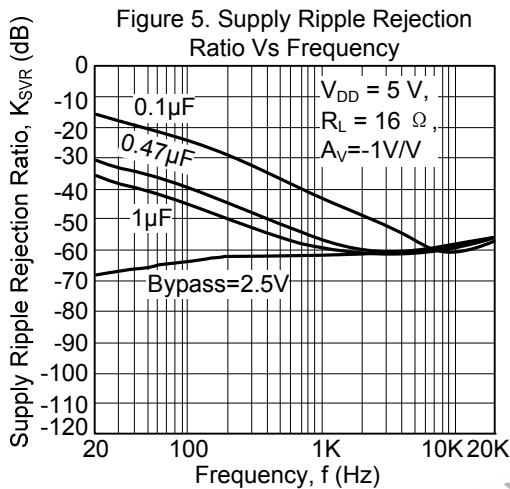
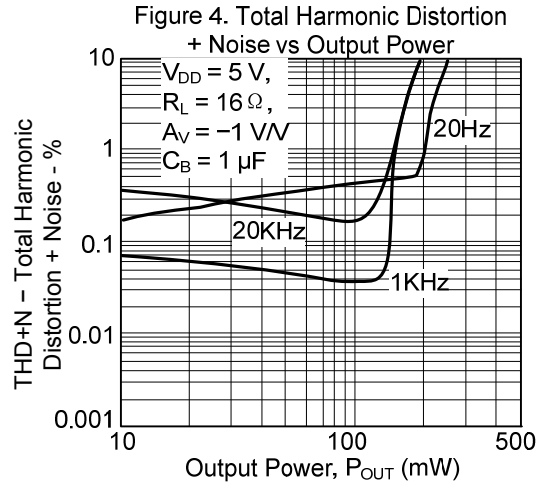
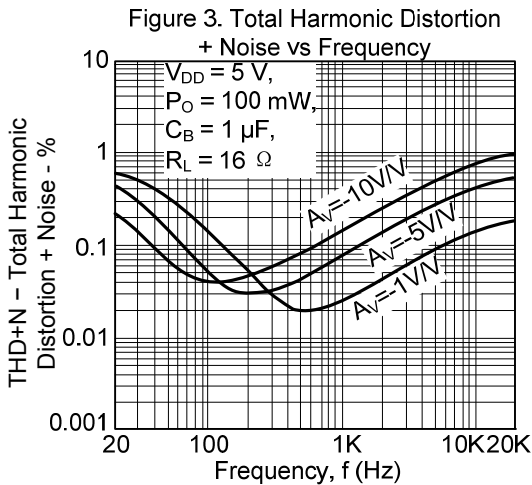
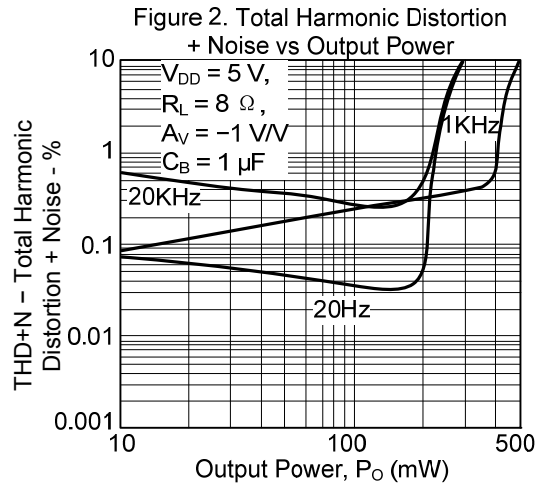
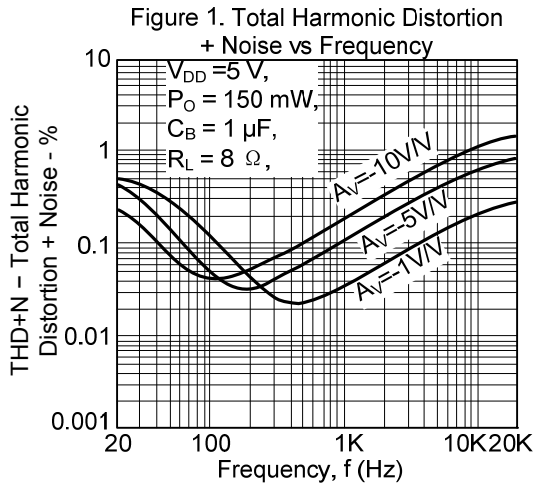

■ TYPICAL CHARACTERISTICS(Cont.)

Figure 7. Crosstalk vs Frequency

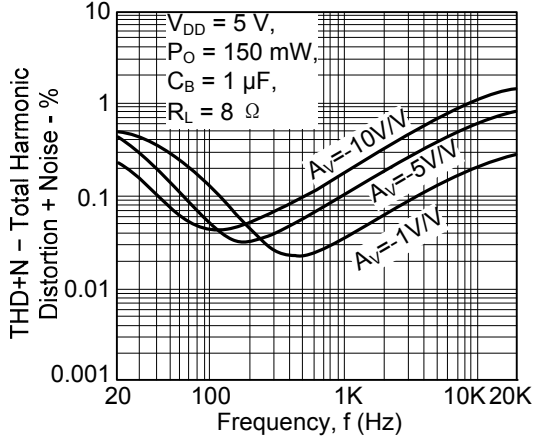

Figure 8. Crosstalk vs Frequency

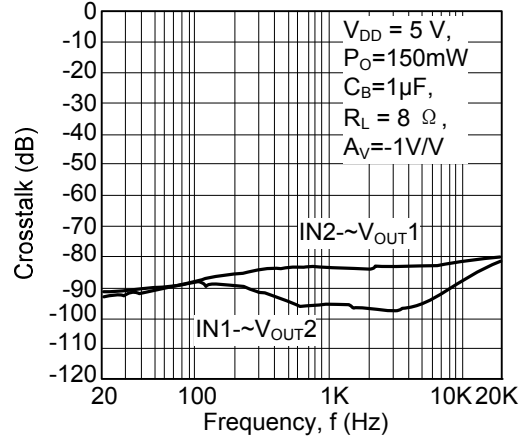

Figure 9. Shutdown Attenuation vs Frequency

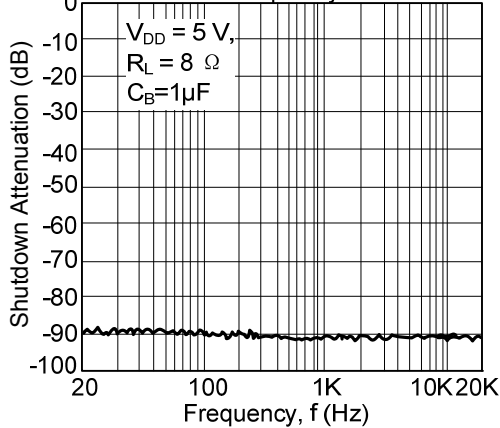

Figure 10. THD + N vs Output Power

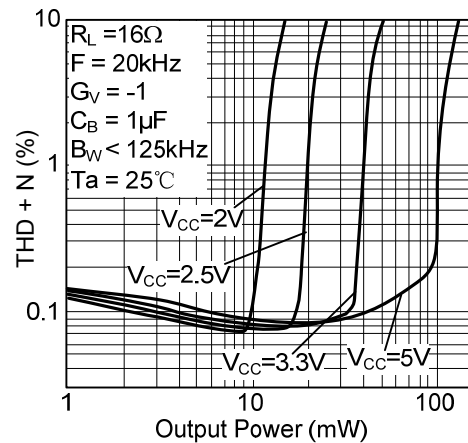

Figure 11. Output Power vs Load Resistance

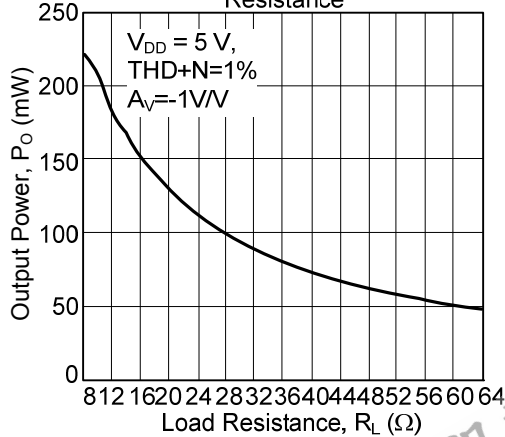
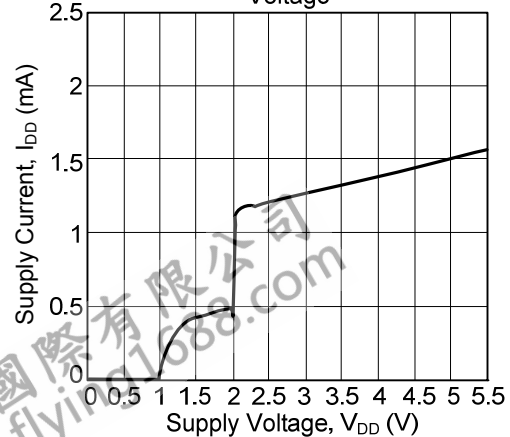
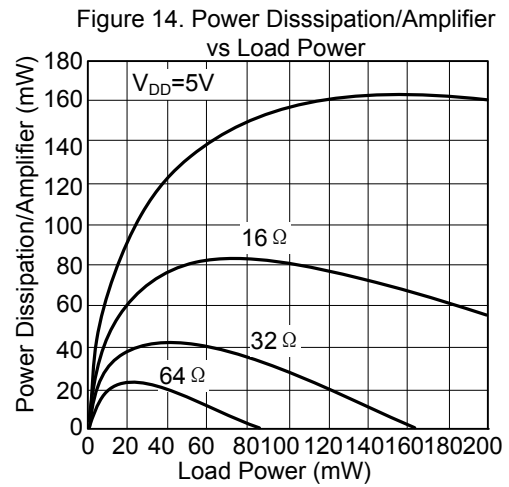
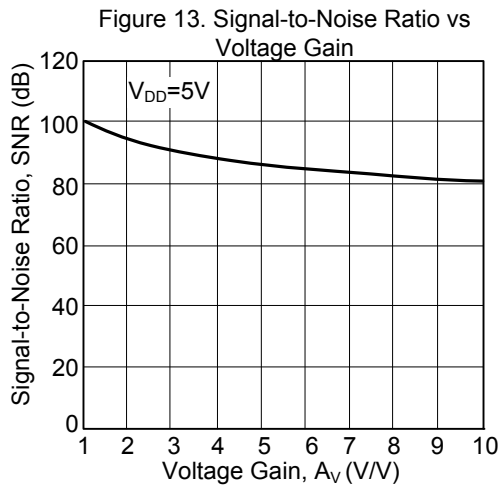

Figure 12. Supply Current vs Supply Voltage



■ TYPICAL CHARACTERISTICS(Cont.)



UTC assumes no responsibility for equipment failures that result from using products at values that exceed, even momentarily, rated values (such as maximum ratings, operating condition ranges, or other parameters) listed in products specifications of any and all UTC products described or contained herein. UTC products are not designed for use in life support appliances, devices or systems where malfunction of these products can be reasonably expected to result in personal injury. Reproduction in whole or in part is prohibited without the prior written consent of the copyright owner. The information presented in this document does not form part of any quotation or contract, is believed to be accurate and reliable and may be changed without notice.