



## PZT4033

## PNP SILICON TRANSISTOR

### PNP SILICON TRANSISTOR

#### DESCRIPTION

The UTC **PZT4033** designed for high current general purpose amplifier applications.

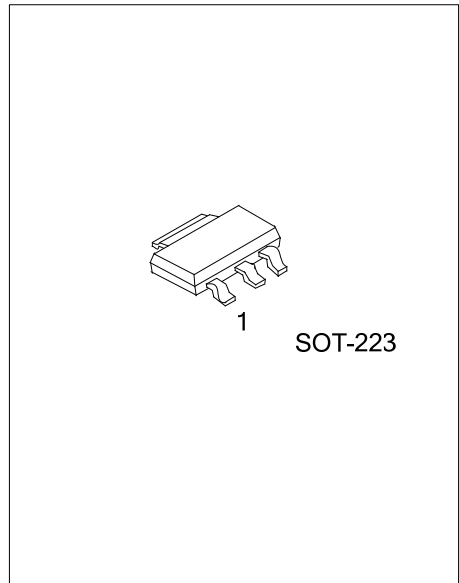

#### ORDERING INFORMATION

Ordering Number	Package	Pin Assignment			Packing
		1	2	3	
PZT4033G-AA3-R	SOT-223	B	C	E	Tape Reel

<p>PZT4033G-AA3-R</p> <ul style="list-style-type: none"> <li>(1) Packing Type</li> <li>(2) Package Type</li> <li>(3) Green Package</li> </ul>	<ul style="list-style-type: none"> <li>(1) R: Tape Reel</li> <li>(2) AA3: SOT-223</li> <li>(3) G: Halogen Free and Lead Free</li> </ul>
---	---

#### MARKING

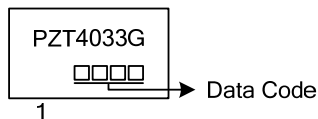

■ ABSOLUTE MAXIMUM RATINGS ( $T_A=25^\circ\text{C}$ , unless otherwise specified)

PARAMETER	SYMBOL	RATING	UNIT
Collector-Base Voltage	$V_{CB0}$	-80	V
Collector-Emitter Voltage	$V_{CEO}$	-80	V
Emitter-Base Voltage	$V_{EBO}$	-5	V
Power Dissipation	$P_D$	2	W
Collector Current	$I_C$	-1	A
Junction Temperature	$T_J$	-65 ~ +150	$^\circ\text{C}$
Storage Temperature	$T_{STG}$	-65 ~ +150	$^\circ\text{C}$

Note: Absolute maximum ratings are those values beyond which the device could be permanently damaged.

Absolute maximum ratings are stress ratings only and functional device operation is not implied.

■ THERMAL DATA

PARAMETER	SYMBOL	RATING	UNIT
Junction to Ambient	$\theta_{JA}$	62.5	$^\circ\text{C}/\text{W}$

■ ELECTRICAL CHARACTERISTICS ( $T_A=25^\circ\text{C}$ , unless otherwise specified)

PARAMETER	SYMBOL	TEST CONDITIONS	MIN	TYP	MAX	UNIT	
Collector-Base Breakdown Voltage	$BV_{CB0}$	$I_C=-10\mu\text{A}, I_E=0$	-80			V	
Collector-Emitter Breakdown Voltage	$BV_{CEO}$	$I_C=-10\text{mA}, I_B=0$	-80			V	
Emitter-Base Breakdown Voltage	$BV_{EBO}$	$I_E=-10\mu\text{A}, I_C=0$	-5			V	
Collector Cut-off Current	$I_{CBO}$	$V_{CB}=-60\text{V}, I_E=0$			-50	nA	
Emitter Cut-off Current	$I_{EBO}$	$V_{EB}=-5\text{V}, I_C=0$			-10	nA	
DC Current Gain	$h_{FE}$	$V_{CE}=-5\text{V}, I_C=-0.1\text{mA}$	75				
		$V_{CE}=-5\text{V}, I_C=-100\text{mA}$	100		300		
		$V_{CE}=-5\text{V}, I_C=-500\text{mA}$	70				
		$V_{CE}=-5\text{V}, I_C=-1\text{A}$	25				
Collector-Emitter Saturation Voltage	$V_{CE(SAT)}$	$I_C=-150\text{mA}, I_B=-15\text{mA}$			-0.15	V	
		$I_C=-500\text{mA}, I_B=-50\text{mA}$			-0.5		
Base-Emitter Saturation Voltage	$V_{BE(SAT)}$	$I_C=-150\text{mA}, I_B=-15\text{mA}$			-0.9	V	
		$I_C=-500\text{mA}, I_B=-50\text{mA}$			-1.1		
Gain Bandwidth Product	f	$V_{CE}=-10\text{V}, I_C=-50\text{mA}, f=1\text{MHz}$	100			MHz	
Output Capacitance	$C_{OB}$	$V_{CB}=-10\text{V}, I_E=0, f=1\text{MHz}$			20	pF	
Input Capacitance	$C_{IB}$	$V_{EB}=-0.5\text{V}, I_C=0, f=1\text{MHz}$			110	pF	
Switching Time	Turn-on Time	$t_{ON}$	$I_C=-500\text{mA}, V_{CE}=-30\text{V}, I_{B1}=I_{B2}=-50\text{mA}$			100	ns
	Storage Time	$t_{STG}$				350	
	Fall Time	$t_F$				50	

## TYPICAL CHARACTERISTICS

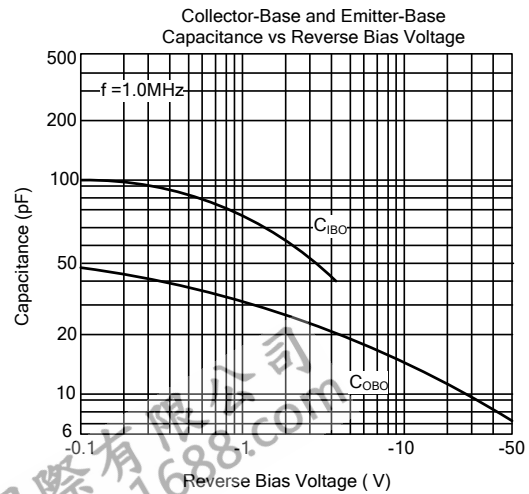
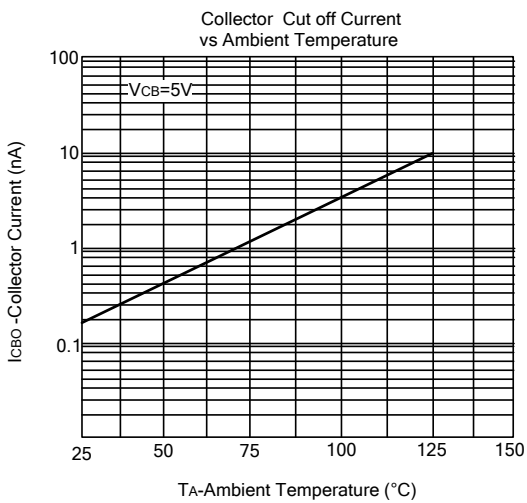
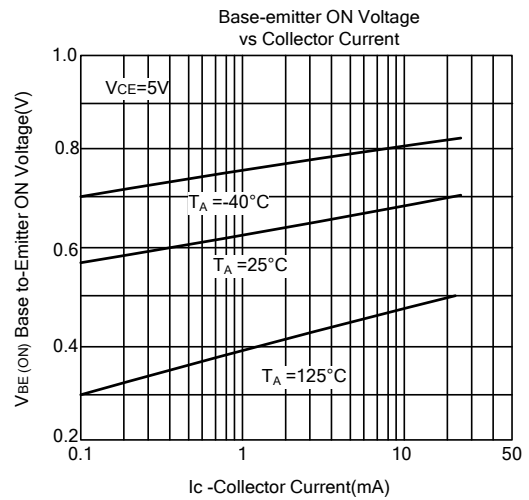
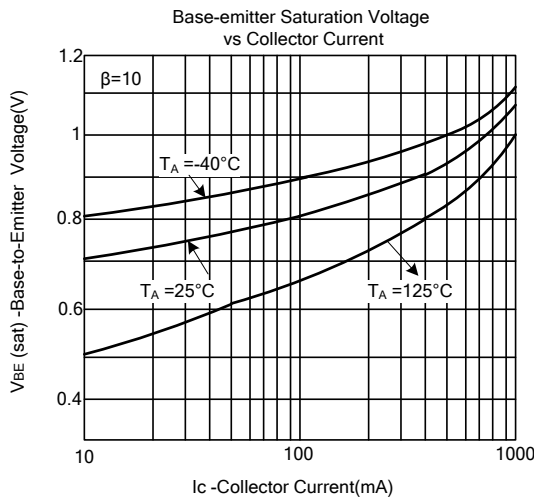
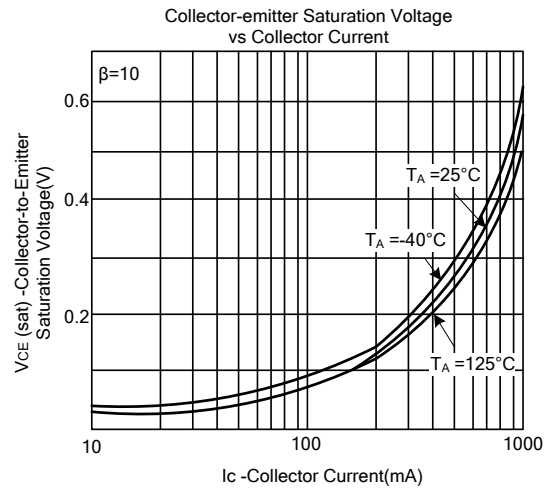
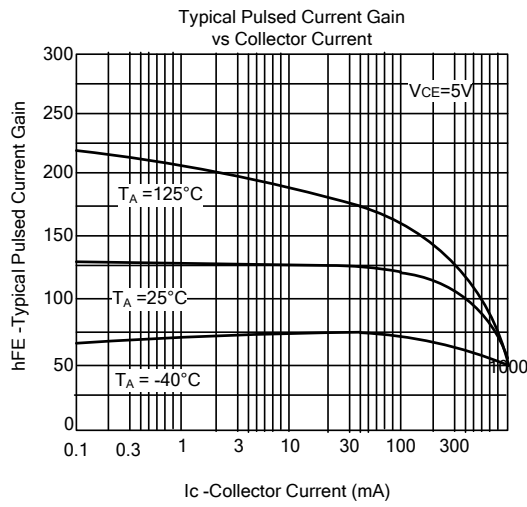

UTC assumes no responsibility for equipment failures that result from using products at values that exceed, even momentarily, rated values (such as maximum ratings, operating condition ranges, or other parameters) listed in products specifications of any and all UTC products described or contained herein. UTC products are not designed for use in life support appliances, devices or systems where malfunction of these products can be reasonably expected to result in personal injury. Reproduction in whole or in part is prohibited without the prior written consent of the copyright owner. The information presented in this document does not form part of any quotation or contract, is believed to be accurate and reliable and may be changed without notice.