



## U7313

CMOS IC

### AUDIO PROCESSOR IC

#### DESCRIPTION

The **U7313** is a 3-stereo inputs and 4-speaker outputs digital audio processor which incorporates volume, tone(bass and treble), balance(left/right)and fader(front/rear) into a single chip. Selectable input gain and loudness function are provided to build a highly effective electronic audio processor having the highest performance and reliability with the external components. The AC signal setting is obtained by resistor networks and switches which are set by programming serial input signal via I<sup>2</sup>C bus. In addition, BiCOMS processes are utilized for low distortion, low noise and low DC stepping.

The **U7313** is designed for quality audio applications in car radio and Hi-Fi systems.

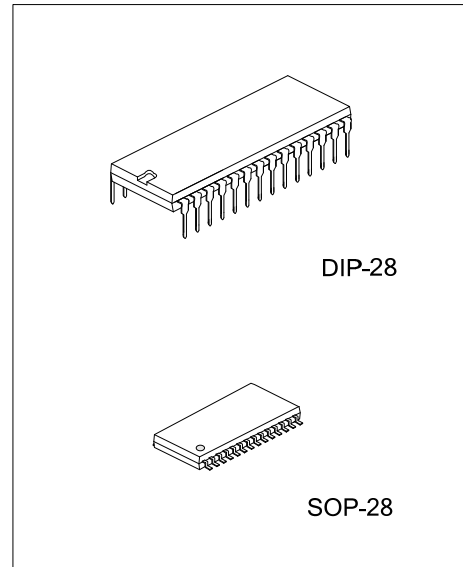

#### FEATURES

- \* Support I<sup>2</sup>C bus interface
- \* 3 stereo inputs and selectable input gain
- \* Volume control in 1.25dB/step
- \* Loudness function
- \* Bass and treble control
- \* 4 independent speakers control
- \* Independent mute function
- \* Low distortion
- \* Low noise and DC stepping

#### ORDERING INFORMATION

Ordering Number	Package	Packing
U7313G-D28-T	DIP-28	Tube
U7313G-S28-R	SOP-28	Tape Reel

<p>U7313G-D28-R</p> <ul style="list-style-type: none"> <li>(1) Packing Type</li> <li>(2) Package Type</li> <li>(3) Green Package</li> </ul>	<ul style="list-style-type: none"> <li>(1) R: Tape Reel</li> <li>(2) D28: DIP-28, S28: SOP-28</li> <li>(3) G: Halogen Free and Lead Free</li> </ul>
---	---



## MARKING

PACKAGE	MARKING
DIP-28	<p>                     28 27 26 25 24 23 22 21 20 19 18 17 16 15 → Date Code                      UTC □□□□                      U7313G                      □□ → Lot Code                      1 2 3 4 5 6 7 8 9 10 11 12 13 14                 </p>
SOP-28	<p>                     28 27 26 25 24 23 22 21 20 19 18 17 16 15 → Date Code                      UTC □□□□                      U7313G                      □□ → Lot Code                      1 2 3 4 5 6 7 8 9 10 11 12 13 14                 </p>

## PIN CONFIGURATION

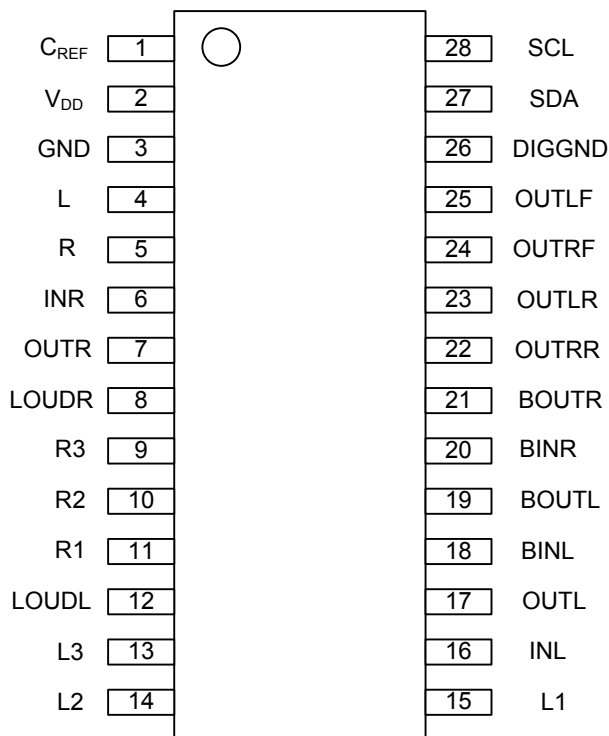

■ PIN DESCRIPTIONS

PIN NO.	PIN NAME	I/O	PIN DESCRIPTION
1	C <sub>REF</sub>		Internal reference voltage, typical value is vdd/2, connect a capacitor to gnd to depress ripple voltage.
2	V <sub>DD</sub>		Supply voltage.
3	GND		Analog gnd.
4	L	I	Connect a capacitor to gnd, the center frequency and quality of the response behavior of treble module can be chosen by the capacitor. (Left speaker)
5	R	I	Connect a capacitor to gnd, the center frequency and quality of the response behavior of treble module can be chosen by the capacitor. (Right speaker)
6	INR	I	Input of volume module.(Right speaker)
7	OUTR	O	Output of gain module.(Right speaker)
8	LOUDR	I	Connect a capacitor to gnd, change the capacitor can adjust the amplitude-frequency characteristic of loudness.(Right speaker)
9	R3	I	Channel 3 input.(Right speaker)
10	R2	I	Channel 2 input.(Right speaker)
11	R1	I	Channel 1 input.(Right speaker)
12	LOUDL	I	Connect a capacitor to gnd, change the capacitor can adjust the frequency-amplitude characteristic of loudness.(Left speaker)
13	L3	I	Channel 3 input.(Left speaker)
14	L2	I	Channel 2 input.(Left speaker)
15	L1	I	Channel 1 input.(Left speaker)
16	INL	I	Input of volume module.(Left speaker)
17	OUTL	O	Output of gain module.(Left speaker)
18	BINL	I	See the application circuit, change the capacitor and the resistor can adjust the center frequency and quality of the response behavior of bass module.(Left speaker)
19	BOU TL	I	See the application circuit, change the capacitor and the resistor can adjust the center frequency and quality of the response behavior of bass module. (Left speaker)
20	BINR	I	See the application circuit, change the capacitor and the resistor can adjust the center frequency and quality of the response behavior of bass module. (Right speaker)
21	BOU TR	I	See the application circuit, change the capacitor and the resistor can adjust the center frequency and quality of the response behavior of bass module. (Right speaker)
22	OUTRR	O	Output of the right rear speaker.
23	OUTLR	O	Output of left rear speaker.
24	OUTRF	O	Output of right front speaker.
25	OUTLF	O	Output of left front speaker.
26	DIG GND		Digital gnd of serial I <sup>2</sup> C bus.
27	SDA	I/O	Data signal of serial I <sup>2</sup> C bus.
28	SCL	I	Clock signal of serial I <sup>2</sup> C bus.

■ BLOCK DIAGRAM

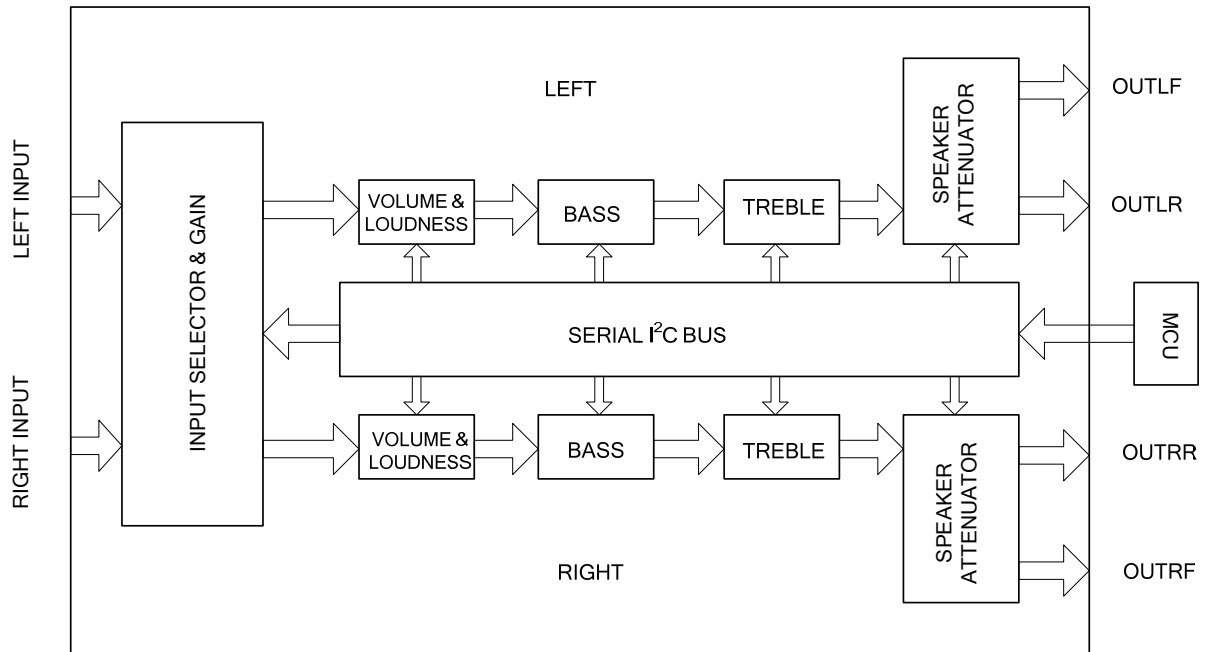

FLYING 汎翔國際有限公司  
www.flying1688.com

■ ABSOLUTE MAXIMUM RATINGS (T<sub>A</sub>=25°C, unless otherwise specified)

PARAMETER	SYMBOL	RATINGS	UNIT
DC Supply Voltage	V <sub>DD</sub>	-0.5~10.2	V
Max Input Clock Speed of Serial I <sup>2</sup> C Bus Signal	B <sub>CLK</sub>	100	KBit/s
Operating Ambient Temperature	T <sub>OPR</sub>	-40~+85	°C
Storage Temperature	T <sub>STG</sub>	-55~ +150	°C

Note: Absolute maximum ratings are those values beyond which the device could be permanently damaged. Absolute maximum ratings are stress ratings only and functional device operation is not implied

■ OVERALL CHARACTERISTICS

PARAMETER	SYMBOL	TEST CONDITIONS	MIN	TYP	MAX	UNIT
DC Supply Voltage	V <sub>DD</sub>		6	9	10	V
Supply Current	I <sub>S</sub>	V <sub>DD</sub> =9V		8	11	mA
Ripple Rejection	RR	V <sub>S</sub> =9V, R <sub>L</sub> =10KΩ, R <sub>G</sub> =600Ω	60	80		dB
Signal to Noise Ratio	S/N	All gains=0dB; V <sub>OUT</sub> =1Vrms		106		dB
Total Harmonic Distortion	THD	V=1Vrms f=1KHZ		0.01	0.1	%
Channel Separation	S(channel)	f=1KHZ		103		dB
Input Gain Per Step	Au(gain)			3.75		dB/step
Volume Control Per Step	Au(volume)			1.25		dB/step
Bass Control Per Step	Au(bass)	f =100HZ		2		dB/step
Treble Control Per Step	Au(treble)	f =20KHZ		2		dB/step
Speaker Control Per Step	Au(speaker)			1.25		dB/step
Total Tracking Error	Au(error)	Au=0 to -20dB -20 to -60dB		0 0	1 2	dB

■ MODULE CHARACTERISTICS

(T<sub>A</sub>=25°C, V<sub>DD</sub> =9V, R<sub>L</sub>=10KΩ, (gain and all control 0dB), f=1KHZ unless otherwise specified)

PARAMETER	SYMBOL	TEST CONDITION	MIN	TYP	MAX	UNIT
<b>DC SUPPLY</b>						
DC Supply Voltage	V <sub>DD</sub>		6	9	10	V
Supply Current	I <sub>S</sub>			8	11	mA
<b>GAIN &amp; INPUT SELECTOR</b>						
Input Resistance	R <sub>I G</sub>	Input1,2,3	35	50	70	KΩ
Clipping Level	V <sub>CL</sub>		2	2.5		Vrms
Input Separation(input 1,2,3)	S <sub>IN</sub>		80	100		dB
Output Load resistance	R <sub>L</sub>	OUTL OUTR	2			KΩ
Gain Range	G <sub>IN</sub>			11.25		dB
Min. Gain	G <sub>INmin</sub>		-1	0	1	dB
Max. Gain	G <sub>INmax</sub>			11.25		dB
Adjacent Gain Steps	G <sub>STEP</sub>			3.75		dB
Input Noise	e <sub>IN</sub>	G=11.25dB		2		uV
DC Shift Voltage Steps	V <sub>DC</sub>	adjacent gain steps		4	20	mV
		G=18.75 to Av max		4		mV
<b>VOLUME CONTROL</b>						
Input Resistance	R <sub>I V</sub>	Pin6,16	20	33	50	KΩ
Control Range	G <sub>V</sub>		70	75	80	dB
Min. Attenuation	AU <sub>MIN</sub>		-1	0	1	dB
Max. Attenuation	AU <sub>MAX</sub>		70	75	80	dB
Adjacent Attenuation Steps	AU <sub>STEP</sub>		0.5	1.25	1.75	dB
Attenuation Set Error	E <sub>A</sub>	Au=0 to -20dB	-1.25	0	1.25	dB
		Au=-20 to -60dB	-3		2	dB

■ MODULE CHARACTERISTICS(Cont.)

PARAMETER	SYMBOL	TEST CONDITION	MIN	TYP	MAX	UNIT
Tracking Error	$E_T$				2	dB
DC Shift Voltage Steps	$V_{DC}$	Adjacent attenuation steps		0	3	mV
		from 0dB to Au max		0.5	7.5	mV
<b>BASS CONTROL</b>						
Control Range	$G_b$	Center freq=100HZ	±12	±14	±16	dB
Adjacent Attenuation Steps	$B_{STEP}$		1	2	3	dB
Internal Feedback Resistance	$R_B$		34	44	58	KΩ
<b>TREBLE CONTROL</b>						
Control Range	$G_t$	Center freq=20KHZ	±13	±14	±15	dB
Adjacent Attenuation Steps	$T_{STEP}$		1	2	3	dB
<b>SPEAKER ATTENUATORS</b>						
Control Range	$G_s$		35	37.5	40	dB
Adjacent Attenuation Steps	$S_{STEP}$		0.5	1.25	1.75	dB
Attenuation Set Error	$E_A$				1.5	dB
Output Mute Attenuation	$A_{MUTE}$		80	100		dB
DC Shift Voltage Steps	$V_{DC}$	adjacent attenuation steps		0	3	mV
		from 0 to mute		1	10	mV
<b>OUTPUTS</b>						
Clipping Level	$V_{OCL}$	d=0.3%	2	2.5		Vrms
Output Load Resistance	$R_L$		2			KΩ
Output Load Capacitance	$C_L$				10	nF
Output Resistance	$R_{OUT}$		30	75	120	Ω
Output DC Voltage	$V_{OUT}$		4.2	4.5	4.8	V
<b>EFFECT OF AUDIO PROCESSING</b>						
Output Noise	$e_{N(OUT)}$	BW=20-20kHz, flat output muted all gains=0dB		2.5		μV
				5	15	μV
		BW=20-20kHz, a curve all gains=0dB		3		μV
Signal to Noise Ratio	S/N	all gains=0dB; $V_{OUT}=1V_{rms}$		106		dB
Distortion	d	$A_u=0, V_{IN}=1V_{rms}$		0.01	0.1	%
		$A_u=-20dB, V_{IN}=1V_{rms}$		0.09		%
		$A_u=-20dB, V_{IN}=0.3V_{rms}$		0.04		%
Channel Separation( left/right)	S(channel)		80	103		dB
Total Tracking Error	$A_u(error)$	$A_u=0$ to -20dB		0	1	dB
		$A_u=-20dB$ to -60dB		0	2	dB
<b>I<sup>2</sup>C BUS INPUT</b>						
Input Voltage	Low	$V_{IL}$			1	V
	High	$V_{IH}$	3			V
Input Current		$I_{IN}$	-5		+5	μA
Output Voltage SDA Acknowledge		$V_{OUT}$	$I_{OUT}=1.6mA$		0.4	V

## APPLICATION CIRCUIT

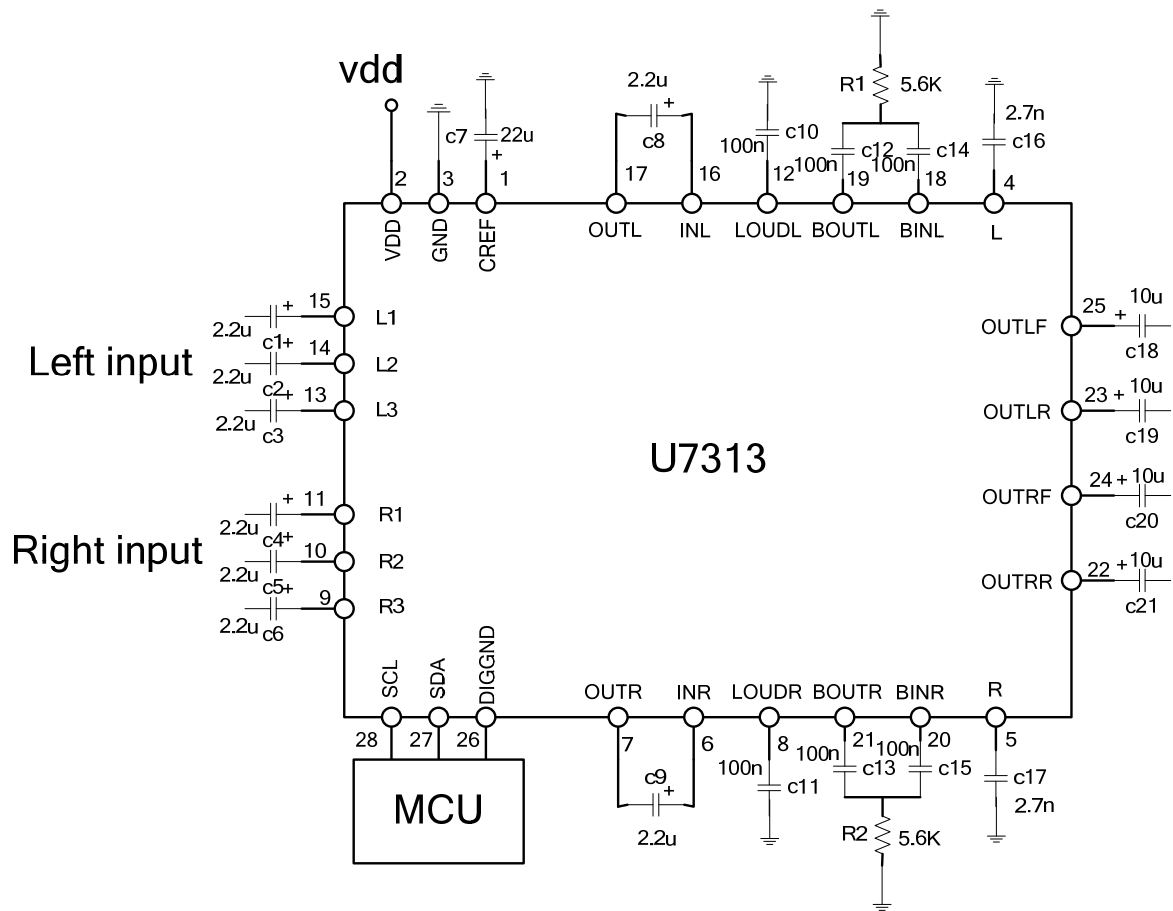

## ■ I<sup>2</sup>C BUS INTERFACE

The master communicated with U7313 by two lines SDA and SCL which should connect pull-up resistors to positive supply voltage. See the figure below.

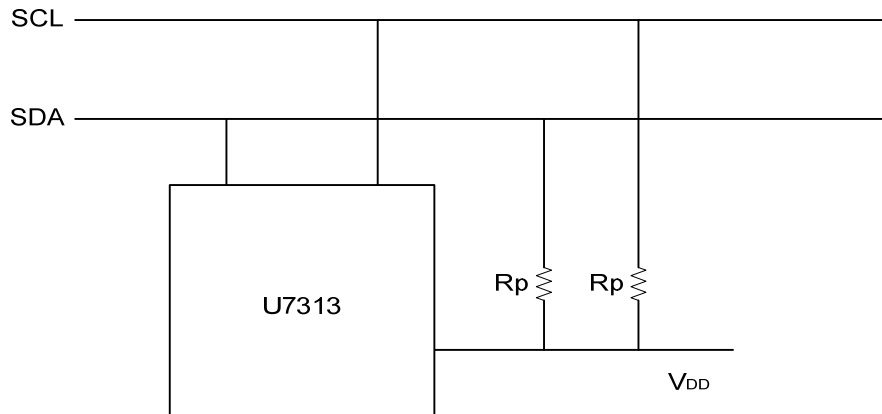

## ■ BYTE FORMAT

The byte transferred from SDA line should contain 8 bit binary data, and followed an acknowledge bit. The MSB is transferred first, Maximum clock speed is 100Kbit/s. Detail see the figures below.

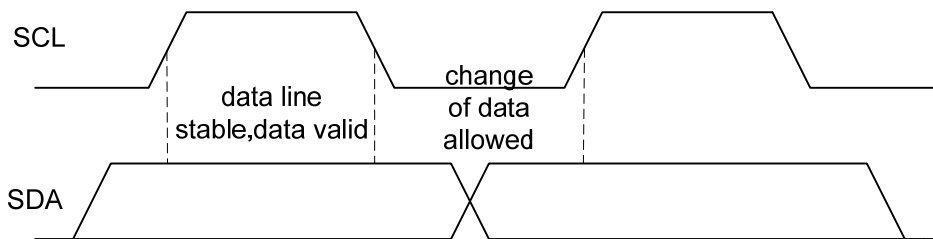
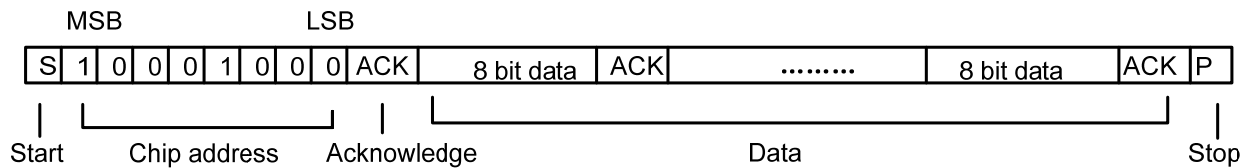

Note: When SCL is high level, SDA data should be stable;  
SDA data can be change only when the SCL is low.

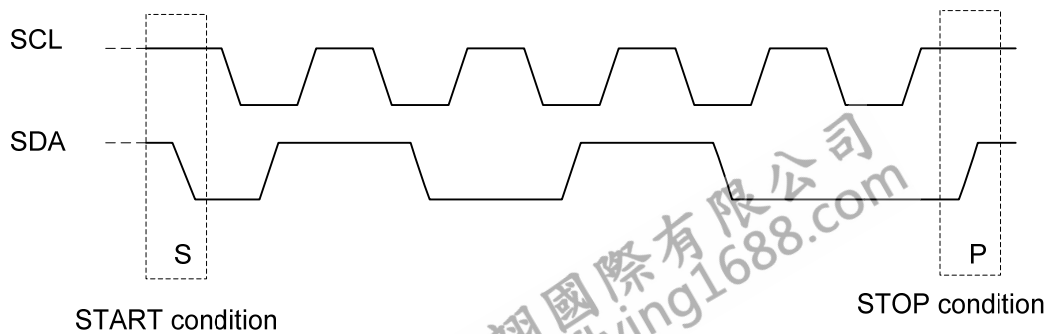

Note: When SCL is high, SDA is high to low, start to receive data.  
When SCL is high, SDA is low to high, stop receiving data.



## ■ ACKNOWLEDGE

The master puts a resistive high level on the SDA line during the acknowledge clock pulse. The slave which acknowledge pull down the SDA line during the acknowledge clock pulse. The SDA line keep in a stable low state. The slave which has been addressed has to generate an acknowledge after receiving each byte. If the SDA line still at the high level during the ninth clock pulse time, the master can generate the stop information to abort the transfer.

If want to abort the acknowledge information, the master can stop detecting the acknowledge by waits one clock without checking, then sends the new data. This approach of course is less protected from misoperation and decrease the noise immunity.

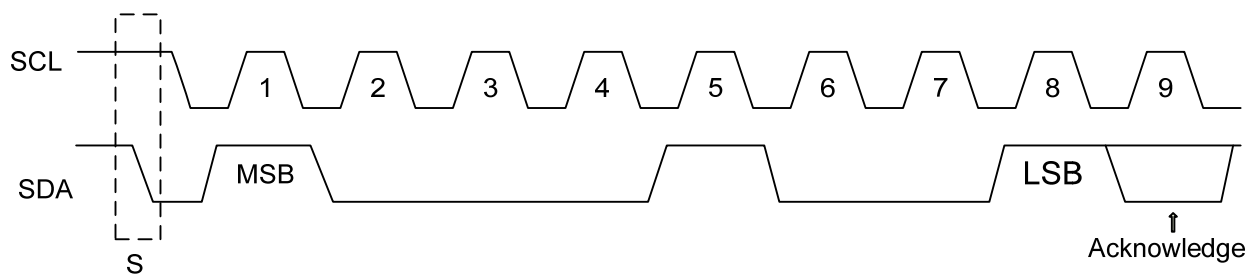

FLYING 汎翔國際有限公司  
[www.flying1688.com](http://www.flying1688.com)

■ FUNCTION CONTROL

Chip address

MSB					LSB		
1	0	0	0	1	0	0	0

Quick reference

MSB					LSB			FUNCTION
0	0	B2	B1	B0	A2	A1	A0	Volume Control
1	0	0	B1	B0	A2	A1	A0	Speaker LF
1	0	1	B1	B0	A2	A1	A0	Speaker RF
1	1	0	B1	B0	A2	A1	A0	Speaker LR
1	1	1	B1	B0	A2	A1	A0	Speaker RR
0	1	0	G1	G0	S2	S1	S0	Gain & Input Selector
0	1	1	0	C3	C2	C1	C0	Bass Control
0	1	1	1	C3	C2	C1	C0	Treble Control

Gain & input selector

MSB				LSB				FUNCTION	
0	1	0	G1	G0	S2	S1	S0	Audio Switch	
								0 0	Stereo 1
								0 1	Stereo 2
								1 0	Stereo 3
								1 1	Stereo4(nonuse)
								0	LOUDNESS ON
								1	LOUDNESS OFF
								0 0	+11.25dB
								0 1	+7.5dB
								1 0	+3.75dB
1 1	0dB								

For example:

Input: stereo 3      Gain:+3.75dB      Loudness on

The 8 bit string is: 0 1 0 1 0 0 1 0



## ■ FUNCTION CONTROL(Cont.)

### Volume control

MSB					LSB			FUNCTION(dB)
0	0	B2	B1	B0	A2	A1	A0	
					0	0	0	0
					0	0	1	-1.25
					0	1	0	-2.5
					0	1	1	-3.75
					1	0	0	-5
					1	0	1	-6.25
					1	1	0	-7.5
					1	1	1	-8.75
0	0	B2	B1	B0	A2	A1	A0	
		0	0	0				0
		0	0	1				-10
		0	1	0				-20
		0	1	1				-30
		1	0	0				-40
		1	0	1				-50
		1	1	0				-60
		1	1	1				-70

For example: Volume -32.5dB the 8 bit string is: 0 0 0 1 1 0 1 0

### Bass control

0	1	1	0	C3	C2	C1	C0	FUNCTION(dB)
				0	0	0	0	-14
				0	0	0	1	-12
				0	0	1	0	-10
				0	0	1	1	-8
				0	1	0	0	-6
				0	1	0	1	-4
				0	1	1	0	-2
				0	1	1	1	0
				1	1	1	1	0
				1	1	1	0	2
				1	1	0	1	4
				1	1	0	0	6
				1	0	1	1	8
				1	0	1	0	10
				1	0	0	1	12
				1	0	0	0	14

For example: Bass control -4dB the 8 bit string is: 0 1 1 0 0 1 0 1

FLYING 汎翔國際有限公司  
[www.flying1688.com](http://www.flying1688.com)

## ■ FUNCTION CONTROL(Cont.)

### Treble control

0	1	1	1	C3	C2	C1	C0	FUNCTION (dB)
				0	0	0	0	-14
				0	0	0	1	-12
				0	0	1	0	-10
				0	0	1	1	-8
				0	1	0	0	-6
				0	1	0	1	-4
				0	1	1	0	-2
				0	1	1	1	0
				1	1	1	1	0
				1	1	1	0	2
				1	1	0	1	4
				1	1	0	0	6
				1	0	1	1	8
				1	0	1	0	10
				1	0	0	1	12
				1	0	0	0	14

For example: Treble control -4dB the 8 bit string is: 0 1 1 1 0 1 0 1

### Speaker attenuators

MSB		LSB			FUNCTION (dB)		
1	0	B1	B0	A2	A1	A0	SPEAKER LF
1	0	B1	B0	A2	A1	A0	SPEAKER RF
1	1	B1	B0	A2	A1	A0	SPEAKER LR
1	1	B1	B0	A2	A1	A0	SPEAKER RR
				0	0	0	0
				0	0	1	-1.25
				0	1	0	-2.5
				0	1	1	-3.75
				1	0	0	-5
				1	0	1	-6.25
				1	1	0	-7.5
				1	1	1	-8.75
		0	0				0
		0	1				-10
		1	0				-20
		1	1				-30
		1	1	1	1	1	Mute

For example: Output SPEAKER RF -15dB

The 8 bit string is: 1 0 1 0 1 1 0 0



■ TYPICAL CHARACTERISTICS

Figure 1: Volume+Loudness attenuation vs. Frequency vs. Volume control (C10,C11=100nF)

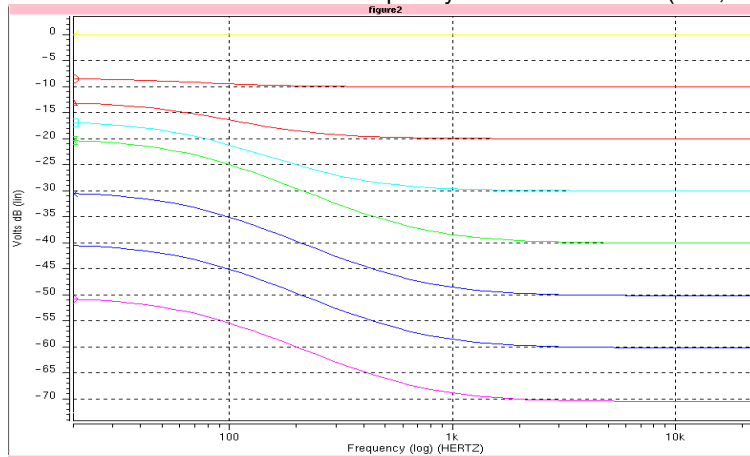

Figure 2: Volume+Loudness attenuation vs. Frequency vs. External Capacitor (Volume=-40dB)

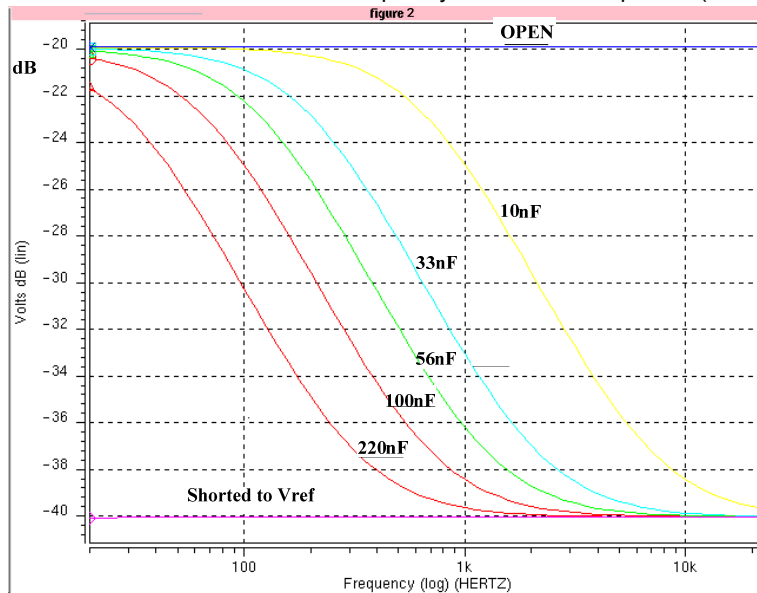
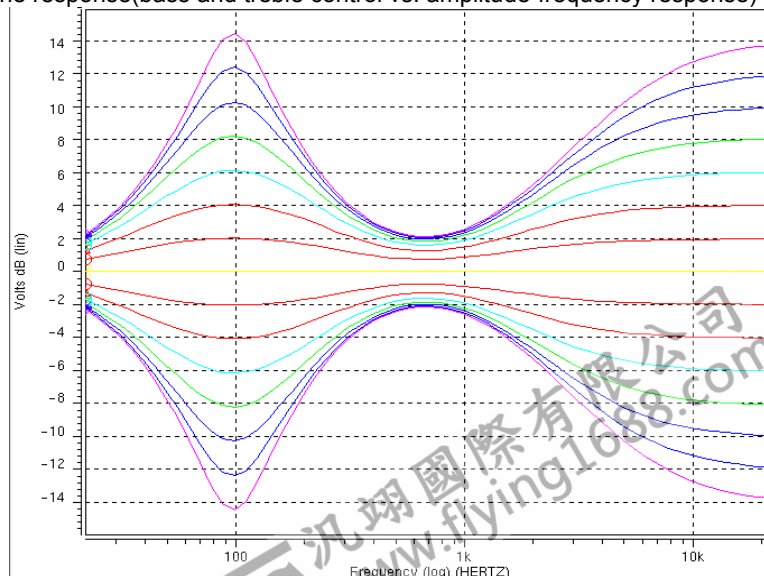

Figure 3: Tone response(bass and treble control vs. amplitude-frequency response)



UTC assumes no responsibility for equipment failures that result from using products at values that exceed, even momentarily, rated values (such as maximum ratings, operating condition ranges, or other parameters) listed in products specifications of any and all UTC products described or contained herein. UTC products are not designed for use in life support appliances, devices or systems where malfunction of these products can be reasonably expected to result in personal injury. Reproduction in whole or in part is prohibited without the prior written consent of the copyright owner. The information presented in this document does not form part of any quotation or contract, is believed to be accurate and reliable and may be changed without notice.