



U74ACT14

CMOS IC

HEX SCHMITT-TRIGGER INVERTERS

DESCRIPTION

The **U74ACT14** contains six inverters with Schmitt-trigger, provides the Function $Y = \bar{A}$.

The **U74ACT14** have hysteresis between the positive-going and negative-going and negative-going input thresholds.

FEATURES

- * Inputs are TTL-Voltage Compatible
- * Outputs source/sink 24mA
- * Pb-Free Packages are available

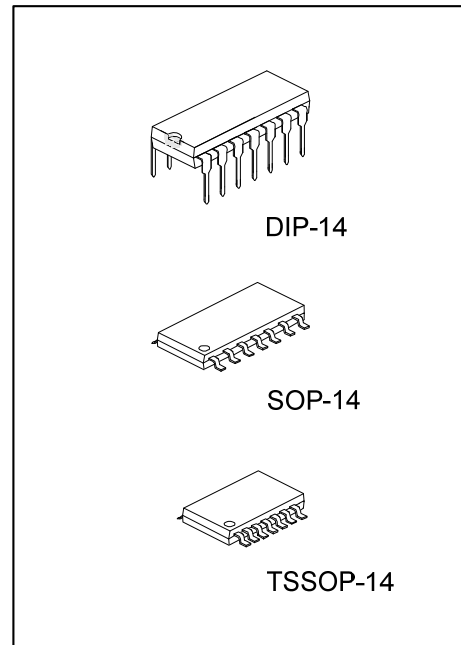

ORDERING INFORMATION

Ordering Number		Package	Packing
Lead Free	Halogen Free		
U74ACT14L-D14-T	U74ACT14G-D14-T	DIP-14	Tube
U74ACT14L-S14-R	U74ACT14G-S14-R	SOP-14	Tape Reel
U74ACT14L-P14-R	U74ACT14G-P14-R	TSSOP-14	Tape Reel

<p>U74ACT14G-D14-T</p> <p>(1) Packing Type (2) Package Type (3) Green Package</p>	<p>(1) T: Tube, R: Tape Reel (2) D14: DIP-14, S14: SOP-14, P14: TSSOP-14 (3) G: Halogen Free and Lead Free, L: Lead Free</p>
---	--

MARKING

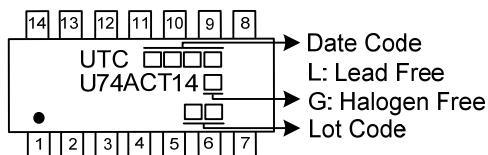

■ PIN CONFIGURATION

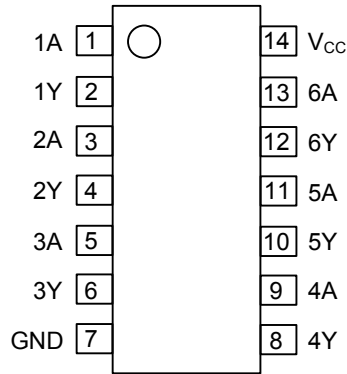

■ FUNCTIONAL DIAGRAM

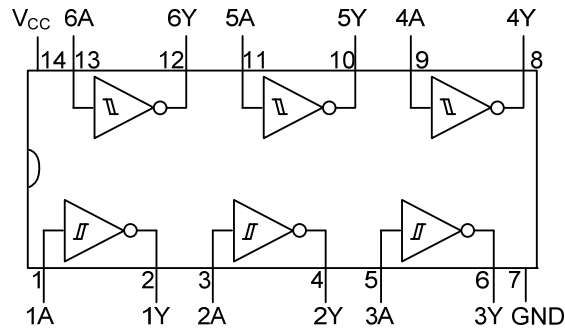

■ FUNCTION TABLE

INPUT	OUTPUT
A	Y
L	H
H	L

■ LOGIC DIAGRAM (positive logic)

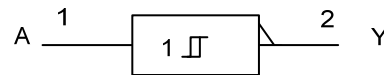
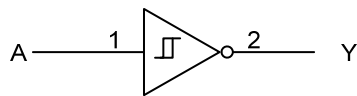

IEC logic symbol

■ ABSOLUTE MAXIMUM RATINGS (unless otherwise specified)

PARAMETER	SYMBOL	RATINGS	UNIT
Supply Voltage	V_{CC}	-0.5 ~ 7	V
Input Voltage	V_{IN}	-0.5 ~ $V_{CC}+0.5$	V
Output Voltage	V_{OUT}	-0.5 ~ $V_{CC}+0.5$	V
Input Clamp Current	I_{IK}	±20	mA
Output Clamp Current	I_{OK}	±20	mA
Output Current	I_{OUT}	±50	mA
V_{CC} or GND Current	I_{CC}	±50	mA
Storage Temperature	T_{STG}	-65 ~ +150	°C

Note: Absolute maximum ratings are those values beyond which the device could be permanently damaged.

Absolute maximum ratings are stress ratings only and functional device operation is not implied.

■ RECOMMENDED OPERATING CONDITIONS

PARAMETER	SYMBOL	MIN	TYP	MAX	UNIT
Supply Voltage	V_{CC}	4.5		5.5	V
Input Voltage	V_{IN}	0		V_{CC}	V
Output Voltage	V_{OUT}	0		V_{CC}	V
Operating Temperature	T_A	-40		+85	°C

■ ELECTRICAL CHARACTERISTICS

PARAMETER	SYMBOL	TEST CONDITIONS	MIN	TYP	MAX	UNIT
High-Level Input Voltage	V_{IH}	$V_{CC}=4.5V$	2.0			V
		$V_{CC}=5.5V$	2.0			V
Low-Level Input Voltage	V_{IL}	$V_{CC}=4.5V$			0.8	V
		$V_{CC}=5.5V$			0.8	V
Hysteresis	V_{TH}	$V_{CC}=4.5V$	0.4		1.4	V
		$V_{CC}=5.5V$	0.5		1.6	V
High-Level Output Voltage	V_{OH}	$V_{CC}=4.5V, I_{OH}=-50\mu A$	4.34	4.49		V
		$V_{CC}=5.5V, I_{OH}=-50\mu A$	5.4	5.49		V
		$V_{CC}=4.5V, I_{OH}=-24mA$	3.86			V
		$V_{CC}=5.5V, I_{OH}=-24mA$	4.86			V
Low-Level Output Voltage	V_{OL}	$V_{CC}=4.5V, I_{OL}=50\mu A$		0.001	0.1	V
		$V_{CC}=5.5V, I_{OL}=50\mu A$		0.001	0.1	V
		$V_{CC}=4.5V, I_{OL}=24mA$			0.36	V
		$V_{CC}=5.5V, I_{OL}=24mA$			0.36	V
Input Leakage Current	$I_{I(LEAK)}$	$V_{CC}=5.5V, V_{IN}=5.5V$ or GND			±0.1	μA
Maximum I_{CC} /Input	I_{CCT}	$V_{CC}=5.5V, V_{IN}=V_{CC}-2.1V$		0.6		mA
Quiescent Supply Current	I_Q	$V_{CC}=5.5V, V_{IN}=V_{CC}$ or GND, $I_{OUT}=0$			2.0	μA
Input Capacitance	C_{IN}	$V_{CC}=OPEN$		4.5		pF

Note: Not more than one output should be tested at a time, and the duration of the test should not exceed 2 ms.

■ SWITCHING CHARACTERISTICS

PARAMETER	SYMBOL	TEST CONDITIONS	MIN	TYP	MAX	UNIT
Propagation delay from input (A) to output(Y)	t_{PLH}	$V_{CC}=5.0V\pm 0.5V, C_L=50pF$	3.0	8.0	10.0	ns
	t_{PHL}	$V_{CC}=5.0V\pm 0.5V, C_L=50pF$	3.0	8.0	10.0	ns

■ OPERATING CHARACTERISTIC

PARAMETER	SYMBOL	TEST CONDITIONS	MIN	TYP	MAX	UNIT
Power Dissipation Capacitance	C_{PD}	$V_{CC}=5$		80		pF

■ TEST CIRCUIT AND WAVEFORMS

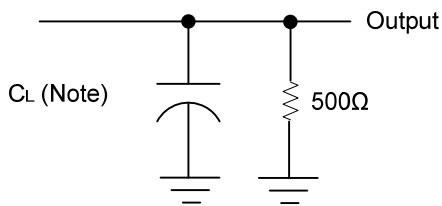

Note: C_L includes probe and jig capacitance.

Fig-1 Load circuitry for switching times.

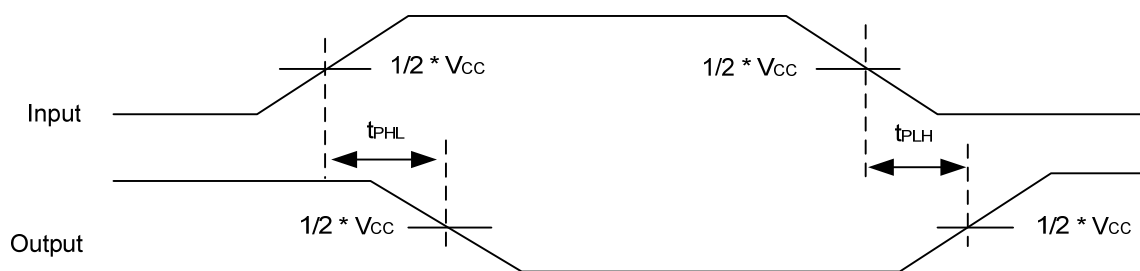

Fig-2 Propagation delay from input(A) to output(Y).

UTC assumes no responsibility for equipment failures that result from using products at values that exceed, even momentarily, rated values (such as maximum ratings, operating condition ranges, or other parameters) listed in products specifications of any and all UTC products described or contained herein. UTC products are not designed for use in life support appliances, devices or systems where malfunction of these products can be reasonably expected to result in personal injury. Reproduction in whole or in part is prohibited without the prior written consent of the copyright owner. UTC reserves the right to make changes to information published in this document, including without limitation specifications and product descriptions, at any time and without notice. This document supersedes and replaces all information supplied prior to the publication hereof.