



U74AHC2G02

CMOS IC

DUAL 2-INPUT NOR GATE

DESCRIPTION

The **U74AHC2G32** is a high speed Si-gate CMOS device.
The **U74AHC2G32** provides two 2-input NOR gates.

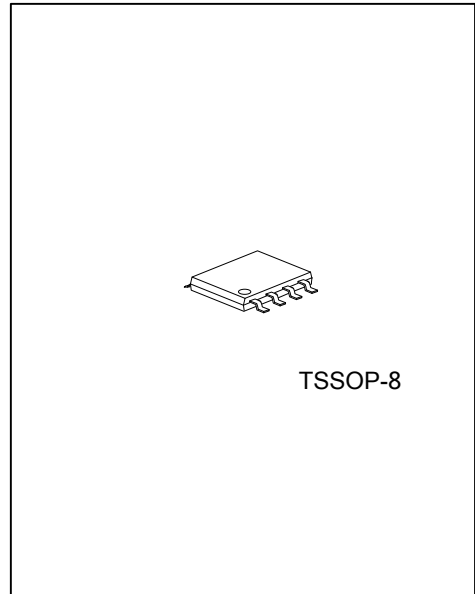

FEATURES

- * Symmetrical output impedance
- * High noise immunity
- * Low power dissipation
- * Balanced propagation delays
- * Multiple package options
- * Specified from -40 °C to +125 °C

ORDERING INFORMATION

Ordering Number		Package	Packing
Lead Free	Halogen Free		
U74AHC2G02L-P08-R	U74AHC2G02G-P08-R	TSSOP-8	Tape Reel

<p>U74AHC2G02G-P08-R</p> <p>(1)Packing Type (2)Package Type (3)Green Package</p>	<p>(1) R: Tape Reel (2) P08: TSSOP-8 (3) G: Halogen Free and Lead Free, L: Lead Free</p>
--	--

MARKING

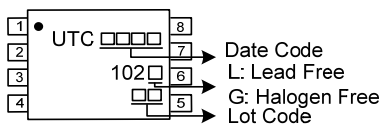

■ PIN CONFIGURATION

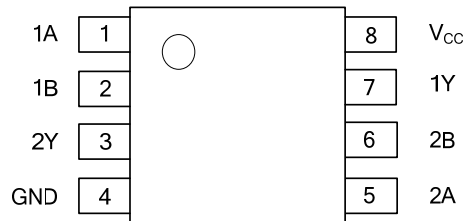

■ PIN CONFIGURATION

PIN No	SYMBOL	DESCRIPTION
1, 5	1A, 2A	Data input
2, 6	1B, 2B	Data input
4	GND	Ground (0V)
7, 3	1Y, 2Y	Data output
8	V _{CC}	Supply voltage

■ FUNCTIONAL DIAGRAM

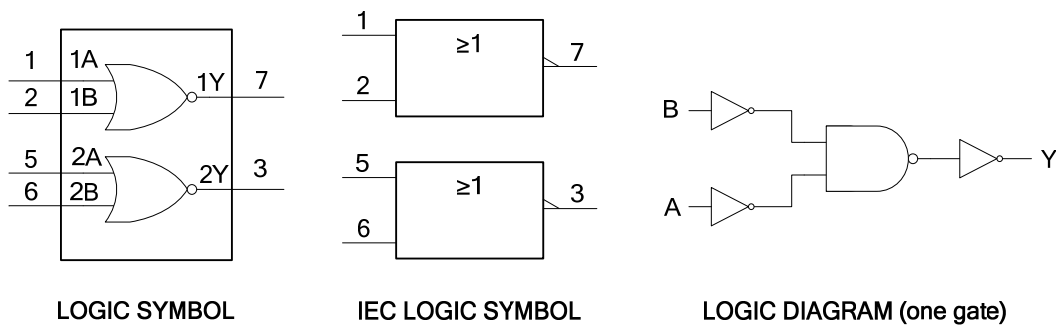

■ FUNCTION TABLE

Input		Output
nA	nB	nY
L	L	H
L	H	L
H	L	L
H	H	L

H=HIGH voltage level; L=LOW voltage level.

FLYING 汎翔國際有限公司
www.flying1688.com

■ ABSOLUTE MAXIMUM RATING

PARAMETER	SYMBOL	CONDITIONS	MIN	TYP	MAX	UNIT
Supply Voltage	V_{CC}		-0.5		+7.0	V
Input Voltage	V_I		-0.5		+7.0	V
Input Clamping Current	I_{IK}	$V_I < -0.5V$	-20			mA
Output Clamping Current	I_{OK}	$V_O < -0.5V$ or $V_O > V_{CC} + 0.5V$			±20	mA
Output Current	I_O	$V_O = -0.5V \sim (V_{CC} + 0.5V)$			±25	mA
Supply Current	I_{CC}				50	mA
Ground Current	I_{GND}		-50			mA
Power Dissipation	P_D				300	mW
Storage Temperature	T_{STG}		-65		+150	°C

Note: The input and output voltage ratings may be exceeded if the input and output current ratings are observed.

■ RECOMMENDED OPERATING CONDITIONS

PARAMETER	SYMBOL	TEST CONDITIONS	MIN	TYP	MAX	UNIT
Supply Voltage	V_{CC}		2	5	5.5	V
Input Voltage	V_I		0		5.5	V
Output Voltage	V_O		0		V_{CC}	V
Input Transition Rise and Fall Rate	$\Delta t / \Delta V$	$V_{CC} = 3.3V \pm 0.3V$			100	ns/V
		$V_{CC} = 5V \pm 0.5V$			20	
Ambient Temperature	T_A		-40	+25	+125	°C

Note: Voltages are referenced to GND (ground=0V).

■ ELECTRICAL CHARACTERISTICS ($T_A = 25^\circ C$, unless otherwise specified)

PARAMETER	SYMBOL	TEST CONDITIONS	MIN	TYP	MAX	UNIT
High-level Input Voltage	V_{IH}	$V_{CC} = 2V$	1.5			V
		$V_{CC} = 3V$	2.1			
		$V_{CC} = 5.5V$	3.85			
Low-level Input Voltage	V_{IL}	$V_{CC} = 2V$			0.5	V
		$V_{CC} = 3V$			0.9	
		$V_{CC} = 5.5V$			1.65	
Output Voltage HIGH-Level	V_{OH}	$V_{CC} = 2V, I_{OH} = -50\mu A$	1.9	2.0		V
		$V_{CC} = 3V, I_{OH} = -50\mu A$	2.9	3.0		
		$V_{CC} = 4.5V, I_{OH} = -50\mu A$	4.4	4.5		
		$V_{CC} = 3V, I_{OH} = -4mA$	2.58			
		$V_{CC} = 4.5V, I_{OH} = -8mA$	3.94			
Output Voltage LOW-Level	V_{OL}	$V_{CC} = 2V, I_{OL} = 50\mu A$			0.1	V
		$V_{CC} = 3V, I_{OL} = 50\mu A$			0.1	
		$V_{CC} = 4.5V, I_{OL} = 50\mu A$			0.1	
		$V_{CC} = 3V, I_{OL} = 4mA$			0.36	
		$V_{CC} = 4.5V, I_{OL} = 8mA$			0.36	
Input Leakage Current	I_I	$V_{CC} = 0$ to $5.5V, V_I = 5.5V$ or GND			±0.1	μA
Quiescent Supply Current	I_{CC}	$V_{CC} = 5.5V, V_I = V_{CC}$ or GND, $I_{OUT} = 0$			1	μA

■ SWITCHING CHARACTERISTICS ($t_r = t_f \leq 3\text{ns}$, $T_A = 25^\circ\text{C}$, unless otherwise specified)

PARAMETER	SYMBOL	TEST CONDITIONS		MIN	TYP	MAX	UNIT
Propagation delay from input (nA, nB) to output (nY)	t_{PLH} / t_{PHL}	$V_{CC}=3.3\pm 0.3\text{V}$	$C_L=15\text{pF}$		5.6	7.9	ns
			$C_L=50\text{pF}$		8.1	11.4	ns
		$V_{CC}=5\pm 0.5\text{V}$	$C_L=15\text{pF}$		3.6	5.5	ns
			$C_L=50\text{pF}$		5.1	7.5	ns

■ CAPACITIVE CHARACTERISTICS ($T_A = 25^\circ\text{C}$, unless otherwise specified)

PARAMETER	SYMBOL	TEST CONDITIONS	MIN	TYP	MAX	UNIT
Input Capacitance	C_i			4	10	pF
Power Dissipation Capacitance	C_{PD}	No load, $f_i=1\text{MHz}$		15		pF

FLYING 汎翔國際有限公司
www.flying1688.com

TEST CIRCUIT AND WAVEFORMS

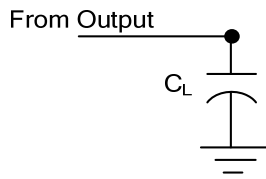

TEST CIRCUIT

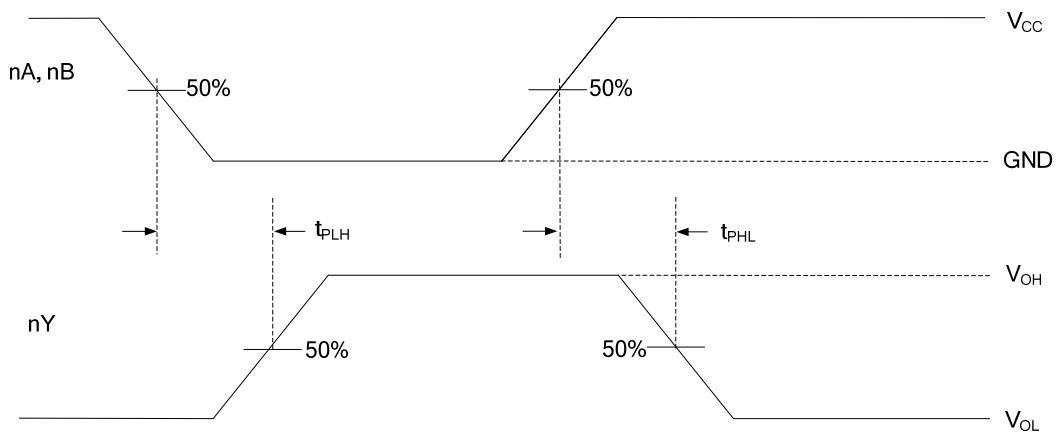

PROPAGATION DELAY TIME

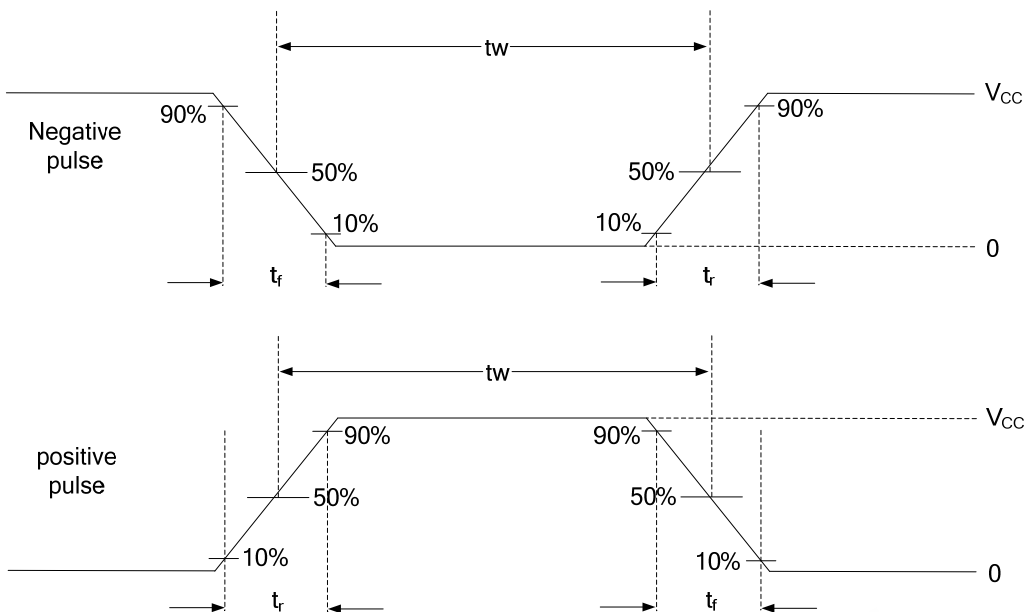

UTC assumes no responsibility for equipment failures that result from using products at values that exceed, even momentarily, rated values (such as maximum ratings, operating condition ranges, or other parameters) listed in products specifications of any and all UTC products described or contained herein. UTC products are not designed for use in life support appliances, devices or systems where malfunction of these products can be reasonably expected to result in personal injury. Reproduction in whole or in part is prohibited without the prior written consent of the copyright owner. UTC reserves the right to make changes to information published in this document, including without limitation specifications and product descriptions, at any time and without notice. This document supersedes and replaces all information supplied prior to the publication hereof.