



U74AHCT1G02

CMOS IC

2-INPUT NOR GATE

DESCRIPTION

The **U74AHCT1G02** is a single 2-input NOR gate which provides the Function.

FEATURES

- * Operation Voltage Range: 2.0~5.5V
- * Low Power Dissipation
- * High noise immunity
- * Balanced propagation delays
- * Specified from -40 to +125°C

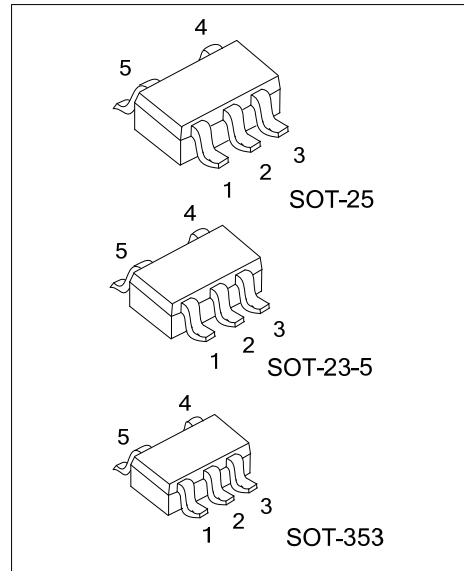

ORDERING INFORMATION

Ordering Number		Package	Packing
Lead Free	Halogen Free		
U74AHCT1G02L-AE5-R	U74AHCT1G02G-AE5-R	SOT-23-5	Tape Reel
U74AHCT1G02L-AF5-R	U74AHCT1G02G-AF5-R	SOT-25	Tape Reel
U74AHCT1G02L-AL5-R	U74AHCT1G02G-AL5-R	SOT-353	Tape Reel

<p>U74AHCT1G02G-AE5-R</p> <p>(1) Packing Type (2) Package Type (3) Green Package</p>	<p>(1) R: Tape Reel (2) AE5: SOT-23-5, AF5: SOT-25, AL5: SOT-353 (3) G: Halogen Free and Lead Free, L: Lead Free</p>
--	--

MARKING

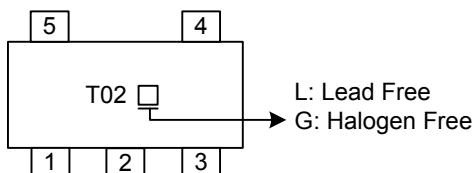

■ PIN CONFIGURATION

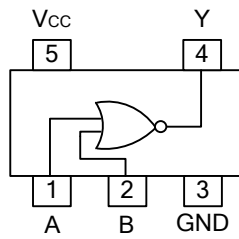

■ FUNCTION TABLE

INPUT		OUTPUT
A	B	Y
L	L	H
L	H	L
H	L	L
H	H	L

■ LOGIC DIAGRAM (positive logic)

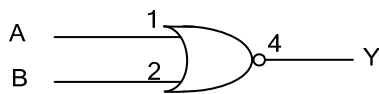

Logic symbol

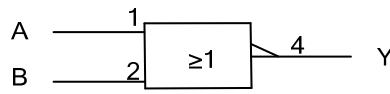

IEC logic symbol

FLYING 汎翔國際有限公司
www.flying1688.com

■ ABSOLUTE MAXIMUM RATINGS (unless otherwise specified)

PARAMETER	SYMBOL	RATINGS	UNIT
Supply Voltage	V_{CC}	-0.5~7	V
Input Voltage	V_{IN}	-0.5~7	V
Output Voltage	V_{OUT}	-0.5~ $V_{CC}+0.5$	V
Input Clamp Current	I_{IK}	±20	mA
Output Clamp Current	I_{OK}	±20	mA
Continuous Output Current	I_{OUT}	±25	mA
V_{CC} or GND Current	I_{CC}	±50	mA
Storage Temperature	T_{STG}	-65 ~ +150	°C

Note: Absolute maximum ratings are those values beyond which the device could be permanently damaged. Absolute maximum ratings are stress ratings only and functional device operation is not implied.

■ RECOMMENDED OPERATING CONDITIONS

PARAMETER	SYMBOL	CONDITIONS	MIN	TYP	MAX	UNIT
Supply Voltage	V_{CC}		4.5	5.0	5.5	V
Input Voltage	V_{IN}		0		5.5	V
Output Voltage	V_{OUT}		0		V_{CC}	V
Input Transition Rise or Fall Times	t_R, t_F	$V_{CC}=3.3V\pm0.3V$				ns/V
		$V_{CC}=5V\pm0.5V$			20	
Operating Temperature	T_A		-40	25	125	°C

■ ELECTRICAL CHARACTERISTICS

PARAMETER	SYMBOL	TEST CONDITIONS	MIN	TYP	MAX	UNIT
High-Level Input Voltage	V_{IH}	$V_{CC}=4.5V\sim5.5V$	2.0			V
Low-Level Input Voltage	V_{IL}	$V_{CC}=4.5V\sim5.5V$			0.8	V
High-Level Output Voltage	V_{OH}	$V_{CC}=4.5V, V_{IN}=V_{IH}$ or $V_{IL}, I_{OH}=-50\mu A$	4.4	4.5		V
		$V_{CC}=4.5V, V_{IN}=V_{IH}$ or $V_{IL}, I_{OH}=-8mA$	3.94			
Low-Level Output Voltage	V_{OL}	$V_{CC}=4.5V, V_{IN}=V_{IH}$ or $V_{IL}, I_{OL}=50\mu A$		0	0.1	V
		$V_{CC}=4.5V, V_{IN}=V_{IH}$ or $V_{IL}, I_{OL}=8mA$			0.36	V
Input Leakage Current	$I_{I(LEAK)}$	$V_{CC}=5.5V, V_{IN}=V_{IH}$ or V_{IL}			±0.1	μA
Quiescent Supply Current	I_Q	$V_{CC}=5.5V, V_{IN}=V_{CC}$ or GND, $I_{OUT}=0$			1	μA
Additional Quiescent Supply Current	ΔI_Q	$V_{CC}=5.5V, V_{IN}=3.4V$; other inputs at V_{CC} or GND, $I_{OUT}=0$			1.35	mA
Input Capacitance	C_{IN}			1.5	10	pF

Note: All unused inputs of the device must be held at V_{CC} or GND to ensure proper device operation.

■ SWITCHING CHARACTERISTICS (Input signal: $P_{RR}\leq 1MHz, Z_O=50\Omega, t_R\leq 3ns, t_F\leq 3ns.$)

PARAMETER	SYMBOL	TEST CONDITIONS	MIN	TYP	MAX	UNIT
Propagation Delay Times	t_{PLH}/t_{PHL}	$V_{CC}=4.5V\sim5.5V, C_L=15pF$		3.5	5.5	ns
		$V_{CC}=4.5V\sim5.5V, C_L=50pF$		4.9	7.5	ns

■ TEST CIRCUIT AND WAVEFORMS

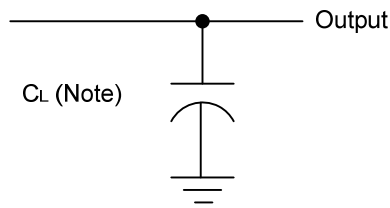

Note: CL includes probe and jig capacitance.

Fig.1 Load circuitry for switching times.

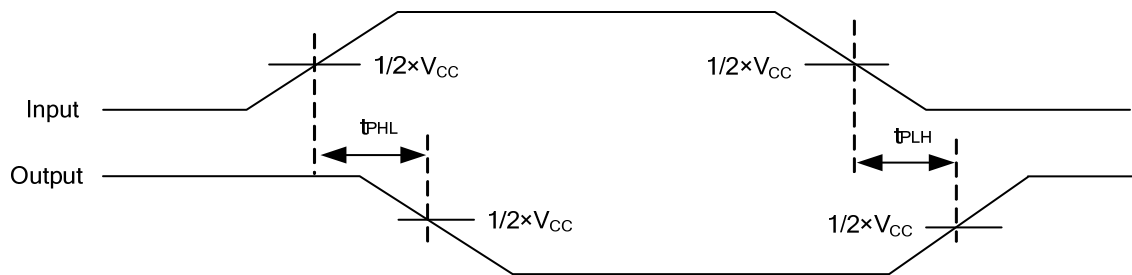

Fig. 2 Propagation delay from input(A and B) to output(Y)

UTC assumes no responsibility for equipment failures that result from using products at values that exceed, even momentarily, rated values (such as maximum ratings, operating condition ranges, or other parameters) listed in products specifications of any and all UTC products described or contained herein. UTC products are not designed for use in life support appliances, devices or systems where malfunction of these products can be reasonably expected to result in personal injury. Reproduction in whole or in part is prohibited without the prior written consent of the copyright owner. UTC reserves the right to make changes to information published in this document, including without limitation specifications and product descriptions, at any time and without notice. This document supersedes and replaces all information supplied prior to the publication hereof.