



U74AHCT1G86

CMOS IC

2-INPUT EXCLUSIVE-OR GATE

DESCRIPTION

The **U74AHCT1G86** is a 2-input EXCLUSIVE-OR gate, it provides the Function $Y=A \oplus B$.

FEATURES

- * Low Power Current: $I_{CC}=1.0\mu A(\text{Max})$
- * High Speed: $t_{PD}=5\text{ns}(\text{Typ})$
- * High Noise Immunity

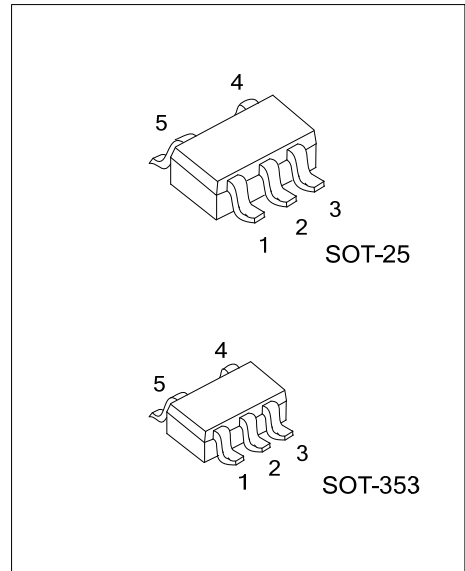

ORDERING INFORMATION

Ordering Number		Package	Packing
Lead Free	Halogen Free		
U74AHCT1G86L-AF5-R	U74AHCT1G86G-AF5-R	SOT-25	Tape Reel
U74AHCT1G86L-AL5-R	U74AHCT1G86G-AL5-R	SOT-353	Tape Reel

<p>U74AHCT1G86G-AF5-R</p> <p>(1) Packing Type (2) Package Type (3) Green Package</p>	<p>(1) R: Tape Reel (2) AF5: SOT-25, AL5: SOT-353 (3) G: Halogen Free and Lead Free, L: Lead Free</p>
--	---

MARKING

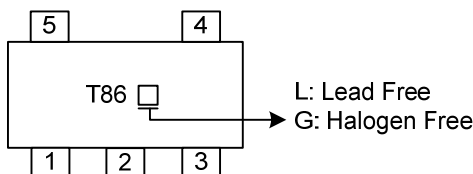

■ PIN CONFIGURATION

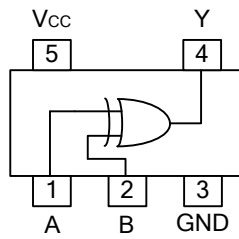

■ FUNCTION TABLE (each gate)

INPUT		OUTPUT
A	B	Y
L	L	L
L	H	H
H	L	H
H	H	L

■ LOGIC DIAGRAM (positive logic)

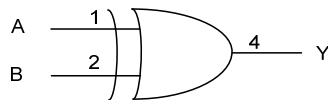

Logic symbol

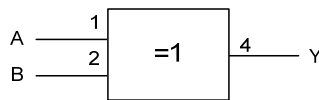

IEC logic symbol

FLYING 汎翔國際有限公司
www.flying1688.com

■ ABSOLUTE MAXIMUM RATINGS (unless otherwise specified)(Note 1)

PARAMETER	SYMBOL	RATINGS	UNIT
Supply Voltage	V _{CC}	-0.5~7	V
Input Voltage	V _{IN}	-0.5~7	V
Output Voltage	V _{OUT}	-0.5~V _{CC} +0.5	V
Input Clamp Current	I _{IK}	-20	mA
Output Clamp Current	I _{OK}	±20	mA
Output Current	I _{OUT}	±25	mA
V _{CC} or GND Current	I _{CC}	±50	mA
Storage Temperature	T _{STG}	-65 ~ +150	°C

Notes: 1. The input and output voltage ratings may be exceeded if the input and output current ratings are observed.
 2. Absolute maximum ratings are those values beyond which the device could be permanently damaged.
 Absolute maximum ratings are stress ratings only and functional device operation is not implied.

■ RECOMMENDED OPERATING CONDITIONS

PARAMETER	SYMBOL	CONDITIONS	MIN	TYP	MAX	UNIT
Supply Voltage	V _{CC}		4.5		5.5	V
Input Voltage	V _{IN}		0		5.5	V
Output Voltage	V _{OUT}		0		V _{CC}	V
Input Transition Rise or Fall Rate	t _R , t _F	V _{CC} =5.0+0.5V			20	ns/V
Operating Temperature	T _A		-40		85	°C

■ STATIC CHARACTERISTICS (T_A=25°C, unless otherwise specified)

PARAMETER	SYMBOL	TEST CONDITIONS	MIN	TYP	MAX	UNIT
High-Level Input Voltage	V _{IH}	V _{CC} =4.5V~5.5V	2.0			V
Low-Level Input Voltage	V _{IL}	V _{CC} =4.5V~5.5V			0.8	V
High-Level Output Voltage	V _{OH}	V _{CC} =4.5V, I _{OH} =-50μA	4.4	4.5		V
		V _{CC} =4.5V, I _{OH} =-8mA	3.94			
Low-Level Output Voltage	V _{OL}	V _{CC} =4.5V, I _{OL} =50μA			0.1	V
		V _{CC} =4.5V, I _{OL} =8mA			0.36	
Input Leakage Current	I _{I(LEAK)}	V _{CC} =5.5V, V _{IN} =V _{CC} or GND			±0.1	μA
Quiescent Supply Current	I _Q	V _{CC} =5.5V, V _{IN} =V _{CC} or GND I _{OUT} =0			1	μA
Additional Quiescent Supply Current	Δ I _Q	V _{CC} =5.5V, V _{IN} =3.4V; I _{OUT} =0; other input at V _{CC} or GND			1.35	mA
Input Capacitance	C _{IN}	V _{IN} =V _{CC} or GND		4	10	pF

■ DYNAMIC CHARACTERISTICS (T_A=25°C, t_R, t_F≤3ns; PRR≤1MHz, unless otherwise specified)

PARAMETER	SYMBOL	TEST CONDITIONS	MIN	TYP	MAX	UNIT
Propagation delay from input (A or B) to output(Y)	t _{PLH}	V _{CC} =5±0.5V, C _L =15pF		5	6.9	ns
	t _{PHL}			5	6.9	
	t _{PLH}	V _{CC} =5±0.5V, C _L =50pF		5.5	7.9	
	t _{PHL}			5.5	7.9	

■ OPERATING CHARACTERISTICS (T_A=25°C, unless otherwise specified)

PARAMETER	SYMBOL	TEST CONDITIONS	MIN	TYP	MAX	UNIT
Power Dissipation Capacitance	C _{PD}	V _{CC} =5V, f=1MHz, No load		18		pF

■ TEST CIRCUIT AND WAVEFORMS

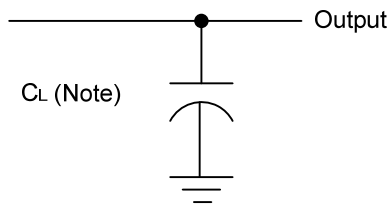

Note: C_L includes probe and jig capacitance.

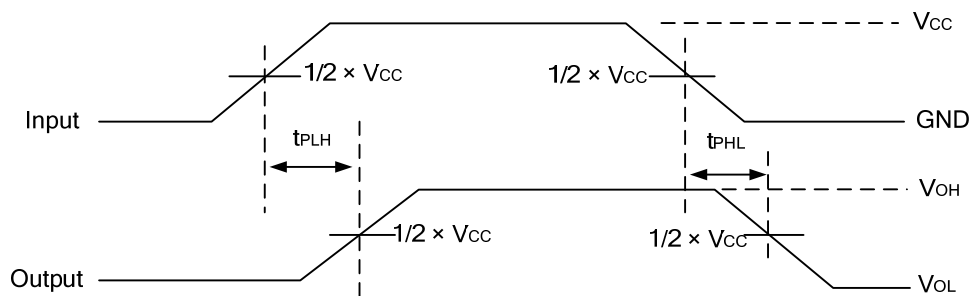

UTC assumes no responsibility for equipment failures that result from using products at values that exceed, even momentarily, rated values (such as maximum ratings, operating condition ranges, or other parameters) listed in products specifications of any and all UTC products described or contained herein. UTC products are not designed for use in life support appliances, devices or systems where malfunction of these products can be reasonably expected to result in personal injury. Reproduction in whole or in part is prohibited without the prior written consent of the copyright owner. UTC reserves the right to make changes to information published in this document, including without limitation specifications and product descriptions, at any time and without notice. This document supersedes and replaces all information supplied prior to the publication hereof.