



## U74HC373

CMOS IC

### OCTAL D-TYPE TRANSPARENT LATCH

#### DESCRIPTION

The **U74HC373** consists of eight D-type transparent latches with 3-state outputs. When latched enable (LE) is high, the latches operate at the transparent mode, and the latches' output will change

corresponding with the data present at D0 to D7. When output enable ( $\overline{OE}$ ) is low, the contents of the latches will be present at the outputs. The outputs will be in the high impedance when  $\overline{OE}$  goes high.

#### FEATURES

- \* Operation Voltage Range: 2~6V
- \* Drive Up to 15 LSTTL Loads
- \* 3-State Outputs
- \* Output Capability Suitable for Bus Driving

#### ORDERING INFORMATION

Ordering Number		Package	Packing
Lead Free	Halogen Free		
U74HC373L-D20-T	U74HC373G-D20-T	DIP-20	Tube
U74HC373L-S20-R	U74HC373G-S20-R	SOP-20	Tape Reel
U74HC373L-R20-R	U74HC373G-R20-R	SSOP-20	Tape Reel
U74HC373L-P20-R	U74HC373G-P20-R	TSSOP-20	Tape Reel

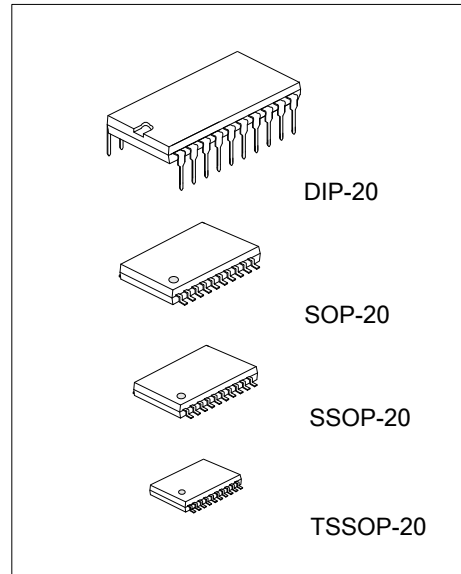

<p>U74HC373G-D20-T</p> <p>(1) Packing Type</p> <p>(2) Package Type</p> <p>(3) Green Package</p>	<p>(1) R: Tape Reel, T: Tube</p> <p>(2) D20: DIP-20, P20: TSSOP-20, R20: SSOP-20, S20: SOP-20</p> <p>(3) G: Halogen Free and Lead Free, L: Lead Free</p>
---	--

#### MARKING

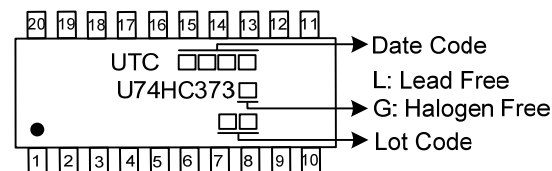

## PIN CONFIGURATION

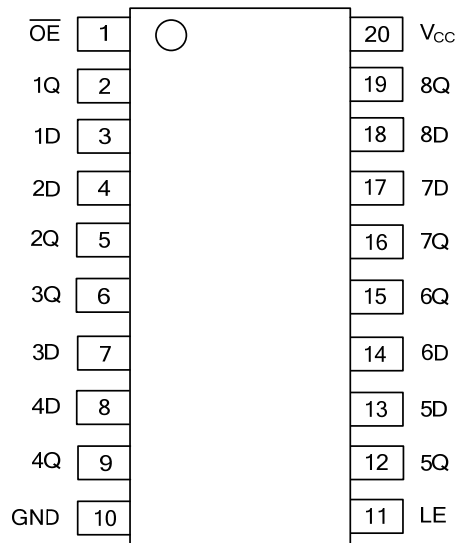

## FUNCTION TABLE

INPUTS(OE)	INPUTS(LE)	INPUTS(D)	OUTPUT(Q)
L	H	H	H
L	H	L	L
L	L	X	Q <sub>0</sub>
H	X	X	Z

Note: H: HIGH voltage level; L: LOW voltage level.

## LOGIC SYMBOL

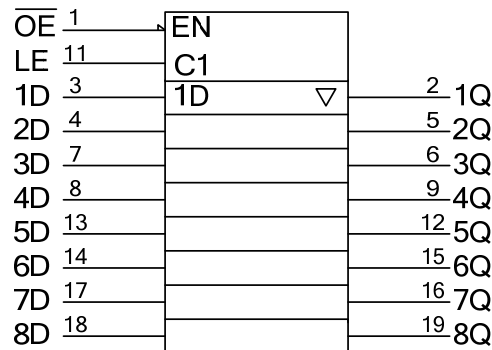

## LOGIC DIAGRAM

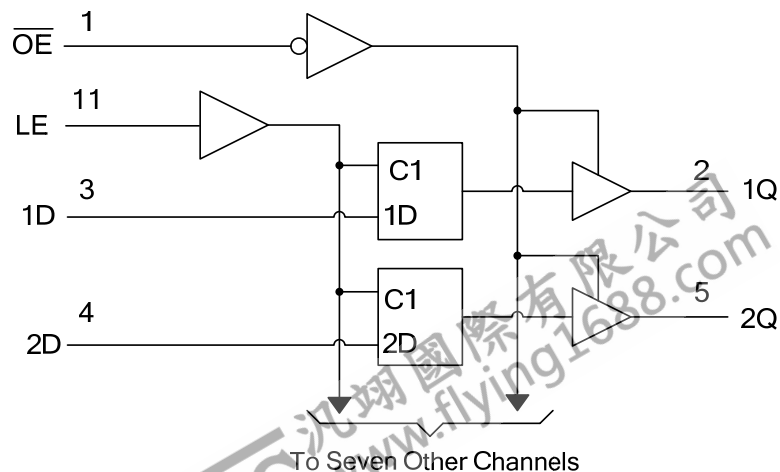

■ ABSOLUTE MAXIMUM RATING (T<sub>A</sub>=25°C, unless otherwise specified)

PARAMETER	SYMBOL	RATINGS	UNIT
Supply Voltage	V <sub>CC</sub>	-0.5 ~ 7	V
V <sub>CC</sub> or GND Current	I <sub>CC</sub>	±70	mA
Output Current	I <sub>OUT</sub>	±35	mA
Input Clamp Current	I <sub>IK</sub>	±20	mA
Output Clamp Current	I <sub>OK</sub>	±20	mA
Operating Temperature	T <sub>OPR</sub>	-40 ~ + 85	°C
Storage Temperature	T <sub>STG</sub>	-65 ~ + 150	°C

Note: Absolute maximum ratings are those values beyond which the device could be permanently damaged.  
Absolute maximum ratings are stress ratings only and functional device operation is not implied.

■ THERMAL DATA

PARAMETER	SYMBOL	RATINGS	UNIT
Junction to Ambient	DIP-20	θ <sub>JA</sub>	°C/W
	SOP-20		
	SSOP-20		
	TSSOP-20		

■ RECOMMENDED OPERATING CONDITIONS (T<sub>A</sub>=25°C, unless otherwise specified)

PARAMETER	SYMBOL	TEST CONDITIONS	MIN	TYP	MAX	UNIT
Supply Voltage	V <sub>CC</sub>		2	5	6	V
High-level Input Voltage	V <sub>IH</sub>	V <sub>CC</sub> =2.0V	1.5			V
		V <sub>CC</sub> =4.5V	3.15			
		V <sub>CC</sub> =6.0V	4.2			
Low-level Input Voltage	V <sub>IL</sub>	V <sub>CC</sub> =2.0V	0		0.5	V
		V <sub>CC</sub> =4.5V	0		1.35	
		V <sub>CC</sub> =6.0V	0		1.8	
Input Voltage	V <sub>IN</sub>		0		V <sub>CC</sub>	V
Output Voltage	V <sub>OUT</sub>	High or low state	0		V <sub>CC</sub>	V
Input Rise or Fall Times	t <sub>r</sub> , t <sub>f</sub>	V <sub>CC</sub> =2.0V			1	µs
		V <sub>CC</sub> =4.5V			0.5	
		V <sub>CC</sub> =6.0V			0.4	

■ ELECTRICAL CHARACTERISTICS (T<sub>A</sub>=25°C, unless otherwise specified)

PARAMETER	SYMBOL	TEST CONDITIONS	MIN	TYP	MAX	UNIT
Output Voltage High-Level	V <sub>OH</sub>	V <sub>CC</sub> =2.0V	1.9	1.998		V
		V <sub>CC</sub> =4.5V	4.4	4.499		
		V <sub>CC</sub> =6.0V	5.9	5.999		
		V <sub>CC</sub> =4.5V, I <sub>OH</sub> =-20µA, V <sub>IN</sub> =V <sub>IH</sub> or V <sub>IL</sub>	3.98	4.3		
		V <sub>CC</sub> =6.0V, I <sub>OH</sub> =-7.8mA, V <sub>IN</sub> =V <sub>IH</sub> or V <sub>IL</sub>	5.48	5.8		
Output Voltage Low-Level	V <sub>OL</sub>	V <sub>CC</sub> =2.0V		2	100	mV
		V <sub>CC</sub> =4.5V		1	100	
		V <sub>CC</sub> =6.0V		1	100	
		V <sub>CC</sub> =4.5V, I <sub>OL</sub> =6mA, V <sub>IN</sub> =V <sub>IH</sub> or V <sub>IL</sub>		170	260	
		V <sub>CC</sub> =6.0V, I <sub>OL</sub> =7.8mA, V <sub>IN</sub> =V <sub>IH</sub> or V <sub>IL</sub>		150	260	
Input Leakage Current	I <sub>I(LEAK)</sub>	V <sub>CC</sub> =6.0V, V <sub>IN</sub> =V <sub>CC</sub> or 0		±0.1	±100	nA
Disable Output Leakage Current	I <sub>OZ</sub>	V <sub>CC</sub> =6.0V, V <sub>OUT</sub> =V <sub>CC</sub> or 0		±0.01	±0.5	µA
Quiescent Supply Current	I <sub>Q</sub>	V <sub>CC</sub> =6.0V, V <sub>IN</sub> =V <sub>CC</sub> or 0, I <sub>OUT</sub> =0			8	µA
Input Capacitance	C <sub>IN</sub>	V <sub>CC</sub> =2.0V~6.0V		3	10	pF

■ SWITCHING CHARACTERISTICS (see test circuit and waveforms)

PARAMETER	SYMBOL	TEST CONDITIONS	MIN	TYP	MAX	UNIT	
Propagation delay from input (D) to output (Q)	$t_{PLH}/t_{PHL}$	$V_{CC}=2.0V$		58	150	ns	
		$V_{CC}=4.5V$		15	30		
		$V_{CC}=6.0V$		13	26		
		$V_{CC}=2.0V$		82	200		
		$V_{CC}=4.5V$		22	40		
		$V_{CC}=6.0V$		19	34		
Propagation delay from input (LE) to output (Q)		$C_L=50pF$	$V_{CC}=2.0V$	73	175		
			$V_{CC}=4.5V$	18	35		
			$V_{CC}=6.0V$	15	30		
			$C_L=150pF$	$V_{CC}=2.0V$	100		225
				$V_{CC}=4.5V$	24		45
				$V_{CC}=6.0V$	20		38
Output enable time from input ( $\overline{OE}$ ) to output (Q)	$t_{PZL}/t_{PZH}$	$V_{CC}=2.0V$		65	150	ns	
		$V_{CC}=4.5V$		17	30		
		$V_{CC}=6.0V$		14	26		
		$C_L=150pF$		$V_{CC}=2.0V$	90		200
				$V_{CC}=4.5V$	23		40
				$V_{CC}=6.0V$	19		34
Output disable time from input ( $\overline{OE}$ ) to output (Q)	$t_{PLZ}/t_{PHZ}$	$V_{CC}=2.0V$	$C_L=50pF$	50	150	ns	
		$V_{CC}=4.5V$		15	30		
		$V_{CC}=6.0V$		13	26		
to Q	$t_r$	$V_{CC}=2.0V$	$C_L=150pF$	28	60	ns	
		$V_{CC}=4.5V$		8	12		
		$V_{CC}=6.0V$		6	10		
Pulse Width	$t_w$	$V_{CC}=2.0V$		80		ns	
		$V_{CC}=4.5V$		16			
		$V_{CC}=6.0V$		14			
Setup Time	$t_{SU}$	$V_{CC}=2.0V$		50		ns	
		$V_{CC}=4.5V$		10			
		$V_{CC}=6.0V$		9			
Hold Time	$t_H$	$V_{CC}=2.0V$		20		ns	
		$V_{CC}=4.5V$		10			
		$V_{CC}=6.0V$		10			

■ OPERATING CHARACTERISTICS ( $T_A=25^\circ C$ , unless otherwise specified)

PARAMETER	SYMBOL	TEST CONDITIONS	MIN	TYP	MAX	UNIT
Power Dissipation Capacitance	$C_{PD}$	No Load		100		pF

## ■ TEST CIRCUIT AND WAVEFORMS

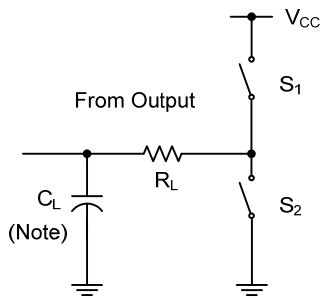

TEST CIRCUIT

	$R_L$	$C_L$	$S_1$	$S_2$
$t_{PZH}$	1k $\Omega$	50pF	Open	Closed
$t_{PZL}$		150pF	Closed	Open
$t_{PHZ}$	1k $\Omega$	50pF	Open	Closed
$t_{PLZ}$			Closed	Open
$t_{PHL}$	-	50pF, 150pF	Open	Open
$t_{PLH}$				

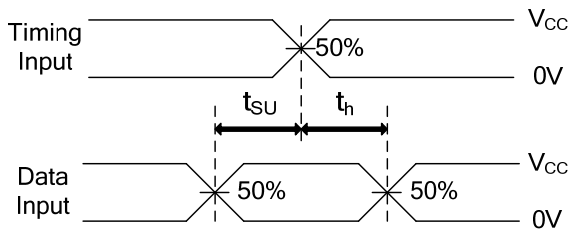

SETUP TIME AND HOLD TIME

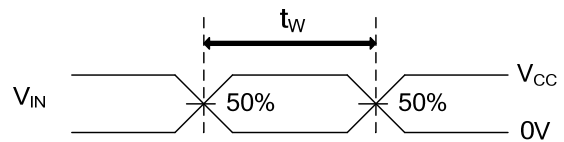

PULSE WIDTH

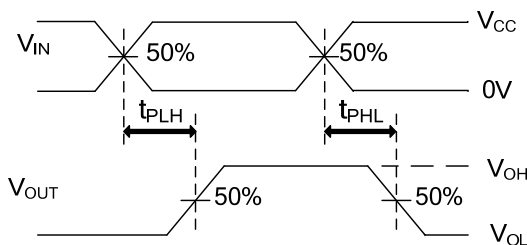

PROPAGATION DELAY TIMES

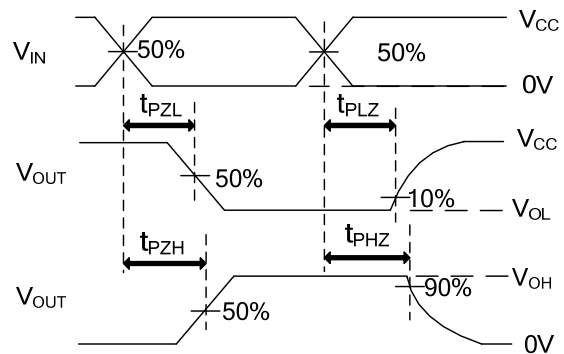

ENABLE AND DISABLE TIMES

Note:  $C_L$  includes probe and jig capacitance.  
 $PRR \leq 1\text{MHz}$ ,  $Z_o = 50\Omega$ ,  $t_R = 6\text{ns}$ ,  $t_F = 6\text{ns}$

UTC assumes no responsibility for equipment failures that result from using products at values that exceed, even momentarily, rated values (such as maximum ratings, operating condition ranges, or other parameters) listed in products specifications of any and all UTC products described or contained herein. UTC products are not designed for use in life support appliances, devices or systems where malfunction of these products can be reasonably expected to result in personal injury. Reproduction in whole or in part is prohibited without the prior written consent of the copyright owner. UTC reserves the right to make changes to information published in this document, including without limitation specifications and product descriptions, at any time and without notice. This document supersedes and replaces all information supplied prior to the publication hereof.