



## U74HC374

CMOS IC

### OCTAL EDGE-TRIGGERED D-TYPE FLIP-FLOPS WITH 3-STATE OUTPUTS

#### DESCRIPTION

The UTC **U74HC374** is an octal edge-triggered D-type flip-flop with 3-state outputs and 8 channels.

#### FEATURES

- \* Operate from 2V to 6V
- \* Max  $t_{PD}$  of 46ns at 4.5 V,  $T_A = 25^\circ C$
- \* Max  $I_{CC}$  of 8 $\mu A$ ,  $T_A = 25^\circ C$
- \* Typical  $V_{OL} < 0.17V$  at  $V_{CC} = 4.5V$ ,  $I_{OUT} = -6mA$ ,  $T_A = 25^\circ C$
- \* Typical  $V_{OH} > 4.3V$  at  $V_{CC} = 4.5V$ ,  $I_{OUT} = 6mA$ ,  $T_A = 25^\circ C$

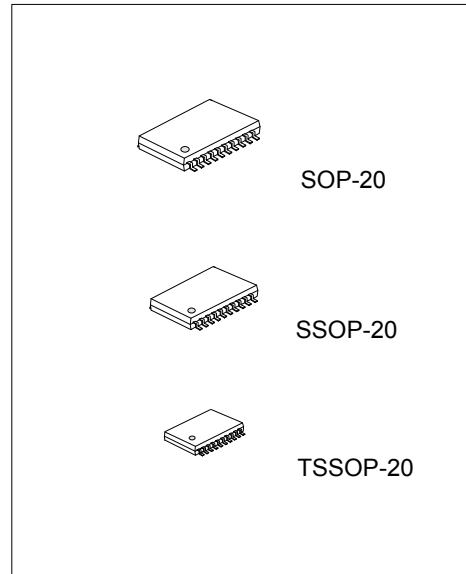

#### ORDERING INFORMATION

Ordering Number		Package	Packing
Lead Free	Halogen Free		
U74HC374L-S20-R	U74HC374G-S20-R	SOP-20	Tape Reel
U74HC374L-R20-R	U74HC374G-R20-R	SSOP-20	Tape Reel
U74HC374L-P20-R	U74HC374G-P20-R	TSSOP-20	Tape Reel

<p>U74HC374G-S20-R</p> <p>(1) Packing Type (2) Package Type (3) Green Package</p>	<p>(1) R: Tape Reel (2) P20: TSSOP-20, R20: SSOP-20, S20: SOP-20 (3) G: Halogen Free and Lead Free, L: Lead Free</p>
---	--

#### MARKING

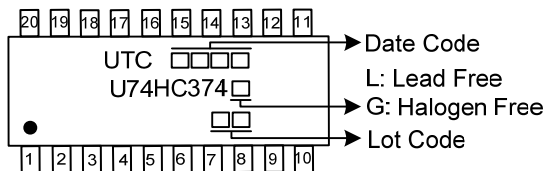

## PIN CONFIGURATION

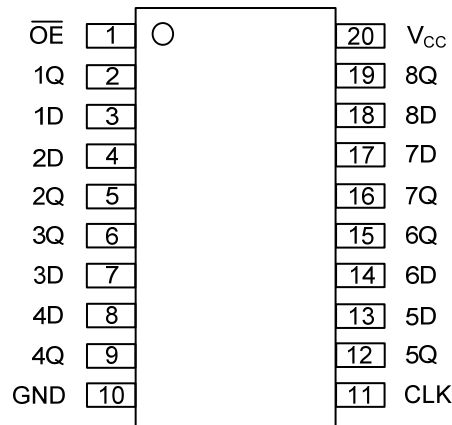

## FUNCTION TABLE

INPUTS( $\overline{OE}$ )	INPUTS(CLK)	INPUTS(D)	OUTPUT(Q)
L	$\uparrow$	H	H
L	$\uparrow$	L	L
L	L/H	X	Q0
H	X	X	Z

## LOGIC SYMBOL

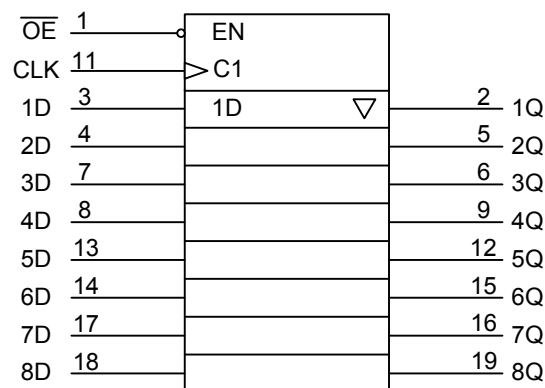

## LOGIC DIAGRAM

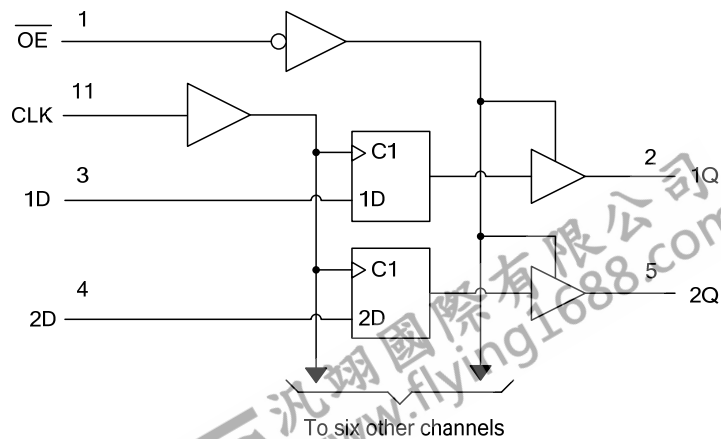

## ■ ABSOLUTE MAXIMUM RATING

PARAMETER	SYMBOL	RATINGS	UNIT
Supply Voltage	$V_{CC}$	-0.5 ~ +7	V
$V_{CC}$ or GND Current	$I_{CC}$	±70	mA
Output Current	$I_{OUT}$	±35	mA
Input Clamp Current	$I_{IK}$	±20	mA
Output Clamp Current	$I_{OK}$	±20	mA
Operating Temperature	$T_{OPR}$	-40 ~ + 85	°C
Storage Temperature	$T_{STG}$	-65 ~ + 150	°C

Note: Absolute maximum ratings are those values beyond which the device could be permanently damaged. Absolute maximum ratings are stress ratings only and functional device operation is not implied.

## ■ THERMAL DATA

PARAMETER	SYMBOL	RATINGS	UNIT
Junction to Ambient	SOP-20	58	°C /W
	SSOP-20	75	
	TSSOP-20	83	

## ■ RECOMMENDED OPERATING CONDITIONS

PARAMETER	SYMBOL	TEST CONDITIONS	MIN	TYP	MAX	UNIT
Supply Voltage	$V_{CC}$		2	5	6	V
High-Level Input Voltage	$V_{IH}$	$V_{CC}=2V$	1.5			V
		$V_{CC}=4.5V$	3.15			V
		$V_{CC}=6V$	4.2			V
Low-Level Input Voltage	$V_{IL}$	$V_{CC}=2V$			0.5	V
		$V_{CC}=4.5V$			1.35	V
		$V_{CC}=6V$			1.8	V
Input Voltage	$V_{IN}$		0		$V_{CC}$	V
Output Voltage	$V_{OUT}$	High or low state	0		$V_{CC}$	V
Input Rise or Fall Times	$t_R, t_F$	$V_{CC}=2V$	0		1000	ns
		$V_{CC}=4.5V$	0		500	ns
		$V_{CC}=6V$	0		400	ns

## ■ ELECTRICAL CHARACTERISTICS

PARAMETER	SYMBOL	TEST CONDITIONS	MIN	TYP	MAX	UNIT
Output Voltage High-Level	$V_{OH}$	$V_{CC}=2V, I_{OH}=-20\mu A$	1.9	1.999		V
		$V_{CC}=4.5V, I_{OH}=-20\mu A$	4.4	4.499		V
		$V_{CC}=6V, I_{OH}=-20\mu A$	5.9	5.999		V
		$V_{CC}=4.5V, I_{OH}=-6mA$	3.98	4.3		V
		$V_{CC}=6V, I_{OH}=-7.8mA$	5.48	5.8		V
Output Voltage Low-Level	$V_{OL}$	$V_{CC}=2V, I_{OL}=20\mu A$		0.002	0.1	V
		$V_{CC}=4.5V, I_{OL}=20\mu A$		0.001	0.1	V
		$V_{CC}=6V, I_{OL}=20\mu A$		0.001	0.1	V
		$V_{CC}=4.5V, I_{OL}=6mA$		0.17	0.26	V
		$V_{CC}=6V, I_{OL}=7.8mA$		0.15	0.26	V
Input Leakage Current	$I_{I(LEAK)}$	$V_{CC}=6V, V_{IN}=V_{CC}$ or GND		±0.1	±100	nA
3-State Leakage Current	$I_{OZ}$	$V_{CC}=6V, V_{OUT}=V_{CC}$ or GND		±0.01	±0.5	µA
Quiescent Supply Current	$I_{CC}$	$V_{CC}=6V, V_{IN}=V_{CC}$ or GND, $I_{OUT}=0$			8	µA
Input Capacitance	$C_I$	$V_{CC}=2V \sim 6V$		3	10	pF

■ SWITCHING CHARACTERISTICS (See TEST CIRCUIT AND WAVEFORMS)

PARAMETER	SYMBOL	TEST CONDITIONS	MIN	TYP	MAX	UNIT	
From CLK to Q	$t_{PLH}/t_{PHL}$	$C_L = 50\text{pF}$	$V_{CC}=2\text{V}$		63	180	ns
			$V_{CC}=4.5\text{V}$		17	36	ns
			$V_{CC}=6\text{V}$		15	31	ns
		$C_L = 150\text{ pF}$	$V_{CC}=2\text{V}$		80	230	ns
			$V_{CC}=4.5\text{V}$		22	46	ns
			$V_{CC}=6\text{V}$		19	39	ns
From $\overline{\text{OE}}$ to Q	$t_{PZL}/t_{PZH}$	$C_L = 50\text{pF}$	$V_{CC}=2\text{V}$		60	150	ns
			$V_{CC}=4.5\text{V}$		16	30	ns
			$V_{CC}=6\text{V}$		14	26	ns
		$C_L = 150\text{ pF}$	$V_{CC}=2\text{V}$		70	200	ns
			$V_{CC}=4.5\text{V}$		25	40	ns
			$V_{CC}=6\text{V}$		22	34	ns
From $\overline{\text{OE}}$ to Q	$t_{PLZ}/t_{PHZ}$	$C_L = 50\text{pF}$	$V_{CC}=2\text{V}$		36	150	ns
			$V_{CC}=4.5\text{V}$		17	30	ns
			$V_{CC}=6\text{V}$		16	26	ns
Any Q	$t_T$	$C_L = 50\text{pF}$	$V_{CC}=2\text{V}$		28	60	ns
			$V_{CC}=4.5\text{V}$		8	12	ns
			$V_{CC}=6\text{V}$		6	10	ns
		$C_L = 150\text{ pF}$	$V_{CC}=2\text{V}$		45	210	ns
			$V_{CC}=4.5\text{V}$		17	42	ns
			$V_{CC}=6\text{V}$		13	36	ns
Maximum Clock Frequency	$f_{MAX}$	$C_L = 50\text{pF}$	$V_{CC}=2\text{V}$	6	12		MHz
			$V_{CC}=4.5\text{V}$	30	60		MHz
			$V_{CC}=6\text{V}$	35	70		MHz
		$C_L = 150\text{pF}$	$V_{CC}=2\text{V}$	6	12		MHz
			$V_{CC}=4.5\text{V}$	30	60		MHz
			$V_{CC}=6\text{V}$	35	70		MHz
Clock Frequency	$f_{CLOCK}$	$V_{CC}=2\text{V}$			6	MHz	
		$V_{CC}=4.5\text{V}$			30	MHz	
		$V_{CC}=6\text{V}$			35	MHz	
Pulse Width	$t_W$	$V_{CC}=2\text{V}$	80			ns	
		$V_{CC}=4.5\text{V}$	16			ns	
		$V_{CC}=6\text{V}$	14			ns	
Setup Time	$t_{SU}$	$V_{CC}=2\text{V}$	100			ns	
		$V_{CC}=4.5\text{V}$	20			ns	
		$V_{CC}=6\text{V}$	17			ns	
Hold Time	$t_H$	$V_{CC}=2\text{V}$	10			ns	
		$V_{CC}=4.5\text{V}$	5			ns	
		$V_{CC}=6\text{V}$	5			ns	

■ OPERATING CHARACTERISTICS ( $T_A=25^\circ\text{C}$ )

PARAMETER	SYMBOL	TEST CONDITIONS	MIN	TYP	MAX	UNIT
Power Dissipation Capacitance	$C_{PD}$	No load		100		pF

## TEST CIRCUIT AND WAVEFORMS

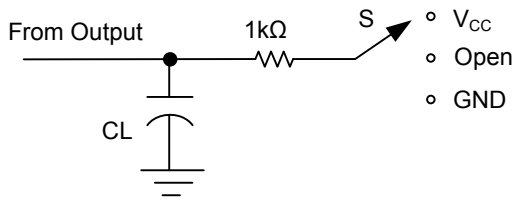

TEST CIRCUIT

TEST	S
$t_{PLH}/t_{PHL}$	Open
$t_{PHZ}/t_{PZH}$	GND
$t_{PLZ}/t_{PZL}$	$V_{CC}$

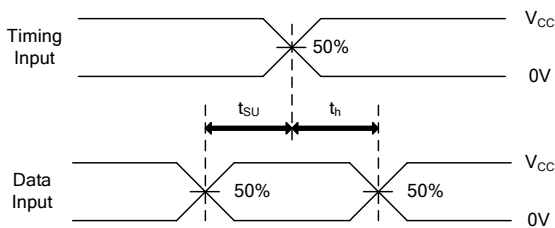

SETUP TIME AND HOLD TIME

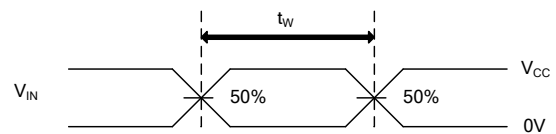

PULSE WIDTH

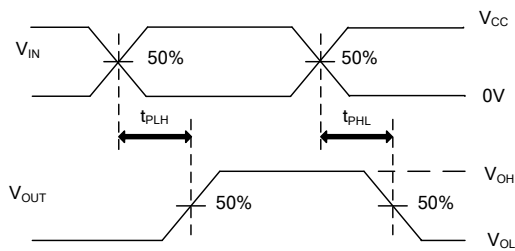

PROPAGATION DELAY TIMES

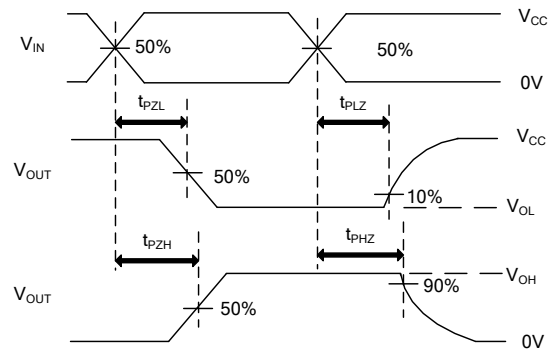

ENABLE AND DISABLE TIMES

Note: CL includes probe and jig capacitance.  
 PRR ≤ 1MHz,  $Z_O = 50\Omega$ ,  $t_R \leq 6ns$ ,  $t_F \leq 6ns$ .

UTC assumes no responsibility for equipment failures that result from using products at values that exceed, even momentarily, rated values (such as maximum ratings, operating condition ranges, or other parameters) listed in products specifications of any and all UTC products described or contained herein. UTC products are not designed for use in life support appliances, devices or systems where malfunction of these products can be reasonably expected to result in personal injury. Reproduction in whole or in part is prohibited without the prior written consent of the copyright owner. UTC reserves the right to make changes to information published in this document, including without limitation specifications and product descriptions, at any time and without notice. This document supersedes and replaces all information supplied prior to the publication hereof.