



U74HC573

CMOS IC

OCTAL TRANSPARENT D-TYPE LATCHES WITH 3-STATE OUTPUTS

DESCRIPTION

The UTC **U74HC573** is a octal transparent D-type latch with 3-state outputs, and it has 8 channels.

FEATURES

- * Operate from 2V to 6V
- * Max t_{PD} of 57ns at 4.5 V
- * Typical $V_{OL} < 0.17V$ at $V_{CC}=4.5V, T_A=25^\circ C$
- * Typical $V_{OH} > 4.3V$ at $V_{CC}=4.5V, T_A=25^\circ C$

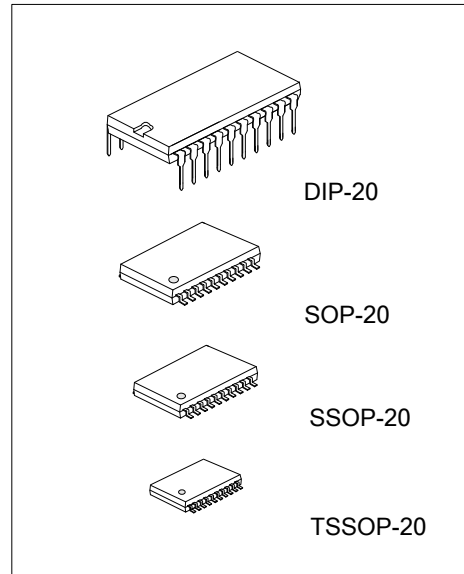

ORDERING INFORMATION

Ordering Number		Package	Packing
Lead Free	Halogen Free		
U74HC573L-D20-T	U74HC573G-D20-T	DIP-20	Tube
U74HC573L-S20-R	U74HC573G-S20-R	SOP-20	Tape Reel
U74HC573L-R20-R	U74HC573G-R20-R	SSOP-20	Tape Reel
U74HC573L-P20-R	U74HC573G-P20-R	TSSOP-20	Tape Reel

<p>U74HC573G-D20-T</p> <p>(1) Packing Type</p> <p>(2) Package Type</p> <p>(3) Green Package</p>	<p>(1) R: Tape Reel, T: Tube</p> <p>(2) D20: DIP-20, P20: TSSOP-20, R20: SSOP-20, S20: SOP-20</p> <p>(3) G: Halogen Free and Lead Free, L: Lead Free</p>
---	--

MARKING

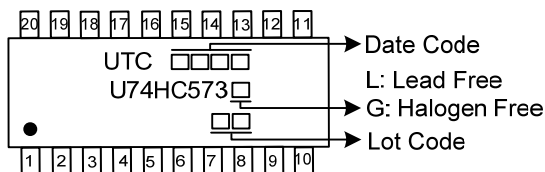

■ PIN CONFIGURATION

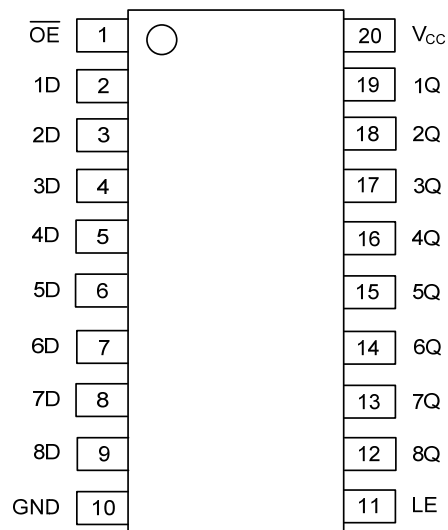

■ FUNCTION TABLE

INPUTS(\overline{OE})	INPUTS(LE)	INPUTS(D)	OUTPUT(Q)
L	H	H	H
L	H	L	L
L	L	X	Q_0
H	X	X	Z

Note: H: HIGH voltage level; L: LOW voltage level.

■ LOGIC SYMBOL

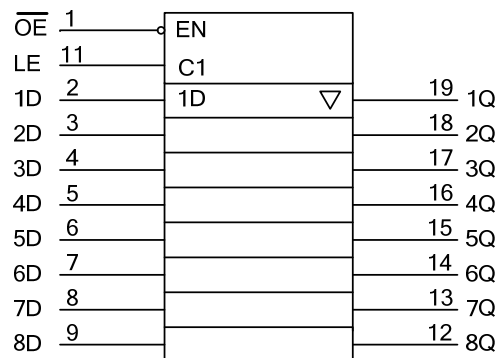

■ LOGIC DIAGRAM

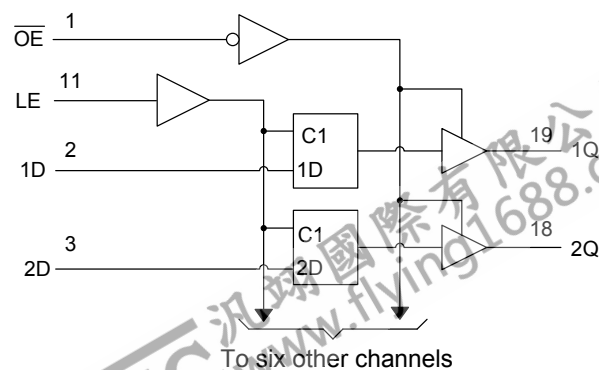

■ ABSOLUTE MAXIMUM RATING ($T_A=25^\circ\text{C}$, unless otherwise specified)

PARAMETER	SYMBOL	RATINGS	UNIT
Supply Voltage	V_{CC}	-0.5 ~ 7	V
V_{CC} or GND Current	I_{CC}	± 70	mA
Output Current	I_{OUT}	± 35	mA
Input Clamp Current	I_{IK}	± 20	mA
Output Clamp Current	I_{OK}	± 20	mA
Operating Temperature	T_{OPR}	-40 ~ + 85	$^\circ\text{C}$
Storage Temperature	T_{STG}	-65 ~ + 150	$^\circ\text{C}$

Note: Absolute maximum ratings are those values beyond which the device could be permanently damaged.
 Absolute maximum ratings are stress ratings only and functional device operation is not implied.

■ THERMAL DATA

PARAMETER	SYMBOL	RATINGS	UNIT
Junction to Ambient	DIP-20	52	$^\circ\text{C/W}$
	SOP-20	80	$^\circ\text{C/W}$
	SSOP-20	96	$^\circ\text{C/W}$
	TSSOP-20	103	$^\circ\text{C/W}$

■ RECOMMENDED OPERATING CONDITIONS ($T_A=25^\circ\text{C}$, unless otherwise specified)

PARAMETER	SYMBOL	TEST CONDITIONS	MIN	TYP	MAX	UNIT
Supply Voltage	V_{CC}		2	5	6	V
High-level Input Voltage	V_{IH}	$V_{CC}=2.0\text{V}$	1.5			V
		$V_{CC}=4.5\text{V}$	3.15			V
		$V_{CC}=6.0\text{V}$	4.2			V
Low-level Input Voltage	V_{IL}	$V_{CC}=2.0\text{V}$	0		0.5	V
		$V_{CC}=4.5\text{V}$	0		1.35	V
		$V_{CC}=6.0\text{V}$	0		1.8	V
Input Voltage	V_{IN}		0		V_{CC}	V
Output Voltage	V_{OUT}	High or low state	0		V_{CC}	V
Input Rise or Fall Times	t_R, t_F	$V_{CC}=2.0\text{V}$	0		1	μs
		$V_{CC}=4.5\text{V}$	0		0.5	μs
		$V_{CC}=6.0\text{V}$	0		0.4	μs

■ ELECTRICAL CHARACTERISTICS ($T_A=25^\circ\text{C}$, unless otherwise specified)

PARAMETER	SYMBOL	TEST CONDITIONS	MIN	TYP	MAX	UNIT
Output Voltage High-Level	V_{OH}	$V_{CC}=2.0\text{V}, I_{OH}=-20\mu\text{A}$	1.9	1.998		V
		$V_{CC}=4.5\text{V}, I_{OH}=-20\mu\text{A}$	4.4	4.499		V
		$V_{CC}=6.0\text{V}, I_{OH}=-20\mu\text{A}$	5.9	5.999		V
		$V_{CC}=4.5\text{V}, I_{OH}=-6\text{mA}$	3.98	4.3		V
		$V_{CC}=6.0\text{V}, I_{OH}=-7.8\text{mA}$	5.48	5.8		V
Output Voltage Low-Level	V_{OL}	$V_{CC}=2.0\text{V}, I_{OL}=20\mu\text{A}$		2	100	mV
		$V_{CC}=4.5\text{V}, I_{OL}=20\mu\text{A}$		1	100	mV
		$V_{CC}=6.0\text{V}, I_{OL}=20\mu\text{A}$		1	100	mV
		$V_{CC}=4.5\text{V}, I_{OL}=6\text{mA}$		170	260	mV
		$V_{CC}=6.0\text{V}, I_{OL}=7.8\text{mA}$		150	260	mV
Input Leakage Current	$I_{I(LEAK)}$	$V_{CC}=6.0\text{V}, V_{IN}=V_{CC}$ or GND		± 0.1	± 100	nA
Disable Output Leakage Current	I_{OZ}	$V_{CC}=6.0\text{V}, V_{OUT}=V_{CC}$ or GND		± 0.01	± 0.5	μA
Quiescent Supply Current	I_Q	$V_{CC}=6.0\text{V}, V_{IN}=V_{CC}$ or GND, $I_{OUT}=0$			8	μA
Input Capacitance	C_{IN}	$V_{CC}=2.0\text{V} \sim 6.0\text{V}$		3	10	pF

■ SWITCHING CHARACTERISTICS (See TEST CIRCUIT AND WAVEFORMS)

PARAMETER	SYMBOL	TEST CONDITIONS	MIN	TYP	MAX	UNIT
Propagation delay from input (D) to output (Q)	t_{PLH}/t_{PHL}	$V_{CC}=2.0V, C_L=50pF$		77	175	ns
		$V_{CC}=4.5V, C_L=50pF$		26	35	ns
		$V_{CC}=6.0V, C_L=50pF$		23	30	ns
		$V_{CC}=2.0V, C_L=150pF$		95	200	ns
		$V_{CC}=4.5V, C_L=150pF$		33	40	ns
		$V_{CC}=6.0V, C_L=150pF$		21	34	ns
Propagation delay from input (LE) to output (Q)		$V_{CC}=2.0V, C_L=50pF$		87	175	ns
		$V_{CC}=4.5V, C_L=50pF$		27	35	ns
		$V_{CC}=6.0V, C_L=50pF$		23	30	ns
		$V_{CC}=2.0V, C_L=150pF$		103	225	ns
		$V_{CC}=4.5V, C_L=150pF$		33	45	ns
		$V_{CC}=6.0V, C_L=150pF$		29	38	ns
Output enable time from input (\overline{OE}) to output (Q)	t_{PZL}/t_{PZH}	$V_{CC}=2.0V, C_L=50pF$		68	150	ns
		$V_{CC}=4.5V, C_L=50pF$		24	30	ns
		$V_{CC}=6.0V, C_L=50pF$		21	26	ns
		$V_{CC}=2.0V, C_L=150pF$		85	200	ns
		$V_{CC}=4.5V, C_L=150pF$		29	40	ns
		$V_{CC}=6.0V, C_L=150pF$		26	34	ns
Output disable time from input (\overline{OE}) to output (Q)	t_{PLZ}/t_{PHZ}	$V_{CC}=2.0V, C_L=50pF$		47	150	ns
		$V_{CC}=4.5V, C_L=50pF$		23	30	ns
		$V_{CC}=6.0V, C_L=50pF$		21	26	ns
Pulse Width	t_w	$V_{CC}=2.0V$	80			ns
		$V_{CC}=4.5V$	16			ns
		$V_{CC}=6.0V$	14			ns
Setup Time	t_{SU}	$V_{CC}=2.0V$	50			ns
		$V_{CC}=4.5V$	10			ns
		$V_{CC}=6.0V$	9			ns
Hold Time	t_H	$V_{CC}=2.0V$	20			ns
		$V_{CC}=4.5V$	5			ns
		$V_{CC}=6.0V$	5			ns

■ OPERATING CHARACTERISTICS ($T_A=25^\circ C$, unless otherwise specified)

PARAMETER	SYMBOL	TEST CONDITIONS	MIN	TYP	MAX	UNIT
Power Dissipation Capacitance	C_{PD}	No load		50		pF

■ TEST CIRCUIT AND WAVEFORMS

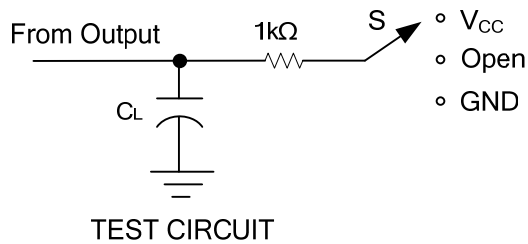

TEST	S
t _{PLH} /t _{PHL}	Open
t _{PHZ} /t _{PZH}	GND
t _{PLZ} /t _{PZL}	V _{CC}

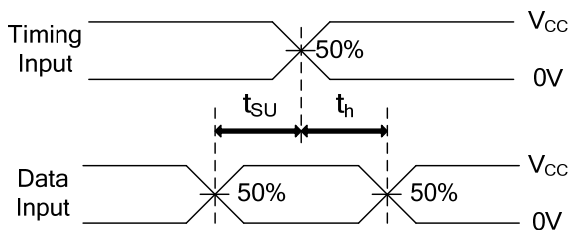

SETUP TIME AND HOLD TIME

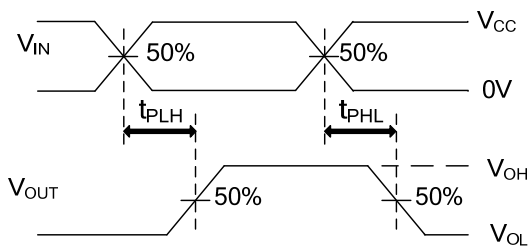

PROPAGATION DELAY TIMES

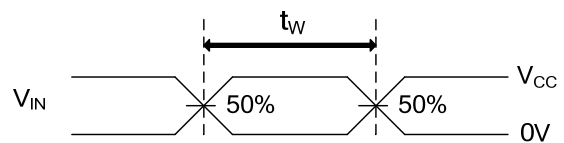

PULSE WIDTH

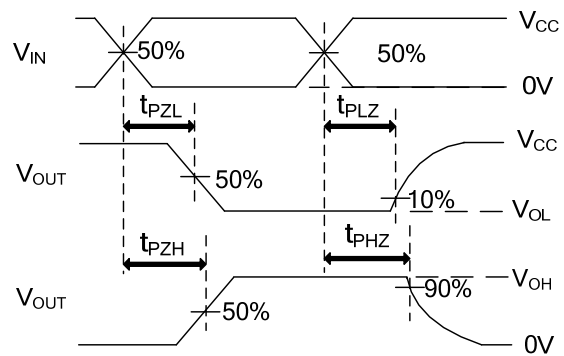

ENABLE AND DISABLE TIMES

Note: C_L includes probe and jig capacitance.
 PRR ≤ 1MHz, Z_o = 50Ω, t_R ≤ 6ns, t_F ≤ 6ns

UTC assumes no responsibility for equipment failures that result from using products at values that exceed, even momentarily, rated values (such as maximum ratings, operating condition ranges, or other parameters) listed in products specifications of any and all UTC products described or contained herein. UTC products are not designed for use in life support appliances, devices or systems where malfunction of these products can be reasonably expected to result in personal injury. Reproduction in whole or in part is prohibited without the prior written consent of the copyright owner. UTC reserves the right to make changes to information published in this document, including without limitation specifications and product descriptions, at any time and without notice. This document supersedes and replaces all information supplied prior to the publication hereof.