



U74LVC2G06

CMOS IC

INVERTERS WITH OPEN-DRAIN OUTPUTS

DESCRIPTION

The **U74LVC2G06** is a dual inverting gate CMOS with open drain output and provides the Boolean function $Y = \overline{A}$ in positive logic device.

This device has a power-down protective circuit to prevent the device from destruction when it is powered down.

FEATURES

- * Operate From 1.65V to 5.5V
- * Inputs Accept Voltages to 5.5V
- * High Noise Immunity
- * Low Power Dissipation
- * Direct Interface with TTL Level

ORDERING INFORMATION

Ordering Number		Package	Packing
Lead Free	Halogen Free		
U74LVC2G06L-AL6-R	U74LVC2G06G-AL6-R	SOT-363	Tape Reel

<p>U74LVC2G06G-AL6-R</p> <p>(1) Packing Type</p> <p>(2) Package Type</p> <p>(3) Green Package</p>	<p>(1) R: Tape Reel</p> <p>(2) AL6: SOT-363</p> <p>(3) G: Halogen Free and Lead Free, L: Lead Free</p>
---	--

MARKING

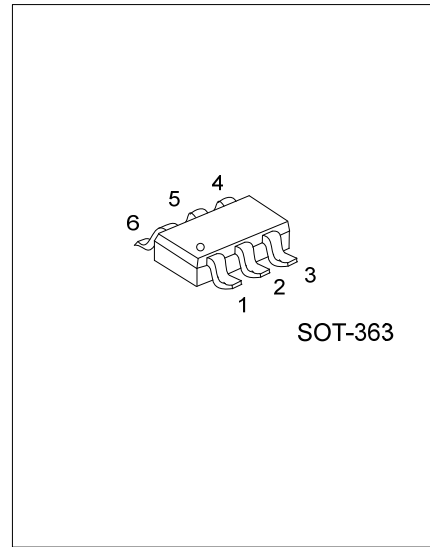
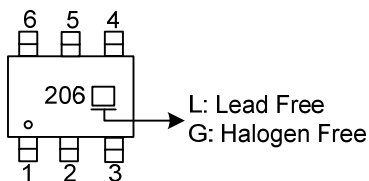

■ PIN CONFIGURATION

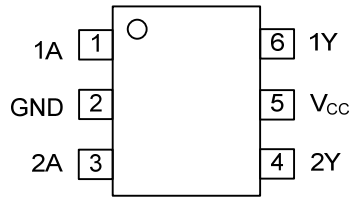

■ FUNCTION TABLE

INPUT(nA)	OUTPUT(nY)
H	L
L	Z

Note: H: HIGH voltage level; L: LOW voltage level; Z: High impedance OFF-state.

■ LOGIC DIAGRAM (positive logic)

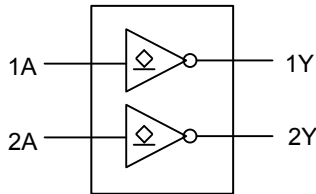

Logic symbol

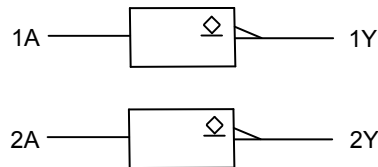

IEC logic symbol

FLYING 汎翔國際有限公司
www.flying1688.com

■ ABSOLUTE MAXIMUM RATING

PARAMETER	SYMBOL	RATINGS	UNIT
Supply Voltage	V_{CC}	-0.5 ~ +6.5	V
Input Voltage	V_{IN}	-0.5 ~ +6.5	V
Output Voltage	V_{OUT}	Active mode	-0.5 ~ +6.5
		Power-down mode	-0.5 ~ +6.5
V_{CC} or GND Current	I_{CC}	±100	mA
Continuous Output Current ($V_{OUT}=0$ to V_{CC})	I_{OUT}	±50	mA
Input Clamp Current ($V_{IN}<0$)	I_{IK}	-50	mA
Output Clamp Current ($V_{OUT}>V_{CC}$ or $V_{OUT}<0$)	I_{OK}	±50	mA
Power Dissipation ($T_A=-40^{\circ}C \sim +125^{\circ}C$)	P_D	300	mW
Storage Temperature Range	T_{STG}	-65 ~ +150	$^{\circ}C$

Note: Absolute maximum ratings are those values beyond which the device could be permanently damaged. Absolute maximum ratings are stress ratings only and functional device operation is not implied.

■ RECOMMENDED OPERATING CONDITIONS

PARAMETER	SYMBOL	TEST CONDITIONS	MIN	TYP	MAX	UNIT
Supply Voltage	V_{CC}		1.65		5.5	V
Input Voltage	V_{IN}		0		5.5	V
Output Voltage	V_{OUT}	Active mode	0		V_{CC}	V
		Power-down mode	0		5.5	V
Operating Temperature	T_A		-40		125	$^{\circ}C$
Input Transition Rise or Fall Rate	t_R / t_F	$V_{CC}=1.65V$ to $2.7V$	0		20	ns/V
		$V_{CC}=2.7V$ to $5.5V$	0		10	ns/V

■ ELECTRICAL CHARACTERISTICS ($T_A=25^{\circ}C$, unless otherwise specified)

PARAMETER	SYMBOL	TEST CONDITIONS	MIN	TYP	MAX	UNIT
High-Level Input Voltage	V_{IH}	$V_{CC}=1.65V \sim 1.95V$	$0.65 \cdot V_{CC}$			V
		$V_{CC}=2.3V \sim 2.7V$	1.7			V
		$V_{CC}=2.7V \sim 3.6V$	2			V
		$V_{CC}=4.5V \sim 5.5V$	$0.7 \cdot V_{CC}$			V
Low-Level Input Voltage	V_{IL}	$V_{CC}=1.65V \sim 1.95V$			$0.35 \cdot V_{CC}$	V
		$V_{CC}=2.3V \sim 2.7V$			0.7	V
		$V_{CC}=2.7V \sim 3.6V$			0.8	V
		$V_{CC}=4.5V \sim 5.5V$			$0.3 \cdot V_{CC}$	V
Low-Level Output Voltage	V_{OL}	$V_{CC}=1.65 \sim 5.5V$	$I_{OL}=100\mu A$		0.1	V
		$V_{CC}=1.65V$	$I_{OL}=4mA$		0.45	V
		$V_{CC}=2.3V$	$I_{OL}=8mA$		0.3	V
		$V_{CC}=2.7V$	$I_{OL}=12mA$		0.4	V
		$V_{CC}=3.0V$	$I_{OL}=24mA$		0.55	V
		$V_{CC}=4.5V$	$I_{OL}=32mA$		0.55	V
Input Leakage Current	$I_{I(LEAK)}$	$V_{IN}=5.5V$ or GND, $V_{CC}=5.5V$		±0.1	±5	μA
Power OFF Leakage Current	I_{OFF}	V_{IN} or $V_{OUT}=5.5V$, $V_{CC}=0V$		±0.1	±10	μA
3-state Output OFF-state Current	I_{OZ}	$V_{IN}=V_{IH}$ or V_{IL} , $V_{OUT}=V_{CC}$ or GND, $V_{CC}=5.5V$		±0.1	±10	μA
Quiescent Supply Current	I_Q	$V_{IN}=V_{CC}$ or GND, $I_{OUT}=0$, $V_{CC}=5.5V$		0.1	10	μA
Additional Quiescent Supply Current Per Input Pin	ΔI_{CC}	$V_{CC}=2.3 \sim 5.5V$, One input at $V_{CC}-0.6V$, Other inputs at V_{CC} or GND		5	500	μA

■ SWITCHING CHARACTERISTICS (T_A=25°C)

PARAMETER	SYMBOL	TEST CONDITIONS	MIN	TYP	MAX	UNIT	
Propagation delay from input (A) to output(Y)	t _{PLZ} / t _{PZL}	V _{CC} =1.8±0.15V, R _L =1KΩ	C _L =30pF	1.0	3.2	6.5	ns
		V _{CC} =2.5±0.2V, R _L =500Ω		0.5	2.0	3.9	ns
		V _{CC} =2.7V	R _L =500Ω, C _L =50pF	1.0	2.6	4.2	ns
		V _{CC} =3.3±0.3V		0.5	2.3	3.4	ns
		V _{CC} =5±0.5V		0.5	1.6	2.9	ns

■ TEST CIRCUIT AND WAVEFORMS

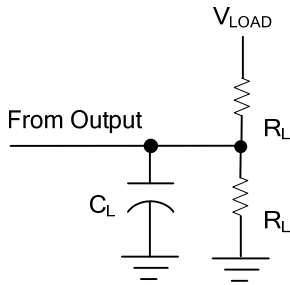

TEST CIRCUIT

V _{CC}	Inputs		V _M	V _{LOAD}	V _Δ	C _L	R _L
	V _{IN}	t _R , t _F					
1.8V±0.15V	V _{CC}	≤2ns	V _{CC} /2	2 x V _{CC}	0.15V	30pF	1KΩ
2.5V±0.2V	V _{CC}	≤2ns	V _{CC} /2	2 x V _{CC}	0.15V	30pF	500Ω
2.7V	2.7V	≤2.5ns	1.5V	6V	0.3V	50pF	500Ω
3.3V±0.3V	2.7V	≤2.5ns	1.5V	6V	0.3V	50pF	500Ω
5V±0.5V	V _{CC}	≤2.5ns	V _{CC} /2	2 x V _{CC}	0.3V	50pF	500Ω

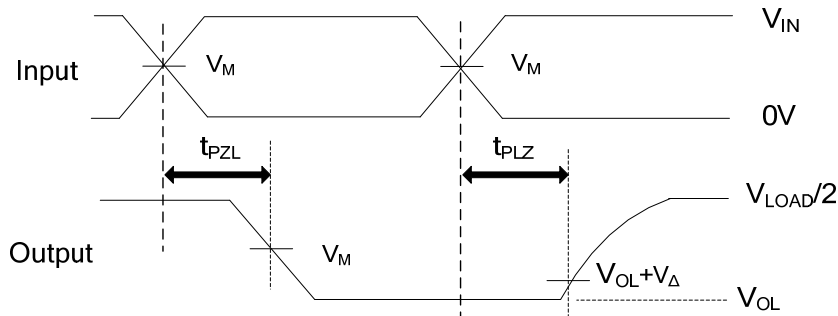

PROPAGATION DELAY TIMES

Note: C_L includes probe and jig capacitance.

All input pulses are supplied by generators having the following characteristics: PRR ≤10MHz, Zo = 50Ω.

UTC assumes no responsibility for equipment failures that result from using products at values that exceed, even momentarily, rated values (such as maximum ratings, operating condition ranges, or other parameters) listed in products specifications of any and all UTC products described or contained herein. UTC products are not designed for use in life support appliances, devices or systems where malfunction of these products can be reasonably expected to result in personal injury. Reproduction in whole or in part is prohibited without the prior written consent of the copyright owner. UTC reserves the right to make changes to information published in this document, including without limitation specifications and product descriptions, at any time and without notice. This document supersedes and replaces all information supplied prior to the publication hereof.