



U74LVC3G14

CMOS IC

TRIPLE SCHMITT-TRIGGER INVERTER

DESCRIPTION

The **U74LVC3G14** is designed as three independent Inverters with Schmitt-trigger action. it may have different input threshold levels for positive-going (V_{T+}) and negative-going (V_{T-}) signals.

This device has power-down protective circuit, preventing device destruction when it is powered down.

FEATURES

- * Wide supply voltage range from 1.65V to 5.5V
- * Inputs accept voltages up to 5.5V
- * I_{OFF} supports partial-power-down mode
- * Low static power consumption; $I_{CC}=10\mu A$ (Max.)

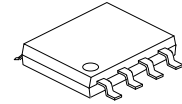

SOP-8

ORDERING INFORMATION

Ordering Number		Package	Packing
Lead Free	Halogen Free		
U74LVC3G14L-S08-R	U74LVC3G14G-S08-R	SOP-8	Tape Reel

<p>U74LVC3G14G-S08-R</p> <p>(1) Packing Type</p> <p>(2) Package Type</p> <p>(3) Green Package</p>	<p>(1) R: Tape Reel</p> <p>(2) S08: SOP-8</p> <p>(3) G: Halogen Free and Lead Free, L: Lead Free</p>
---	--

MARKING

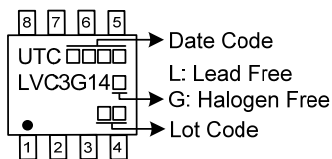

■ PIN CONFIGURATION

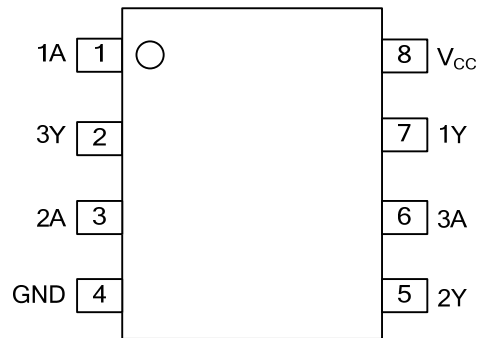

■ FUNCTION TABLE

INPUT(A)	OUTPUT(Y)
H	L
L	H

Note: H: High voltage level; L: Low voltage level.

■ LOGIC DIAGRAM (positive logic)

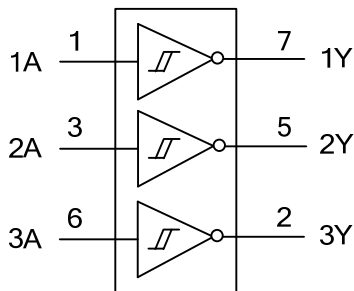

Logic symbol

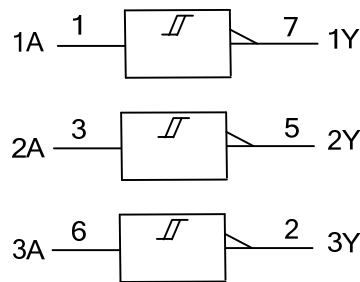

IEC logic symbol

FLYING 汎翔國際有限公司
www.flying1688.com

■ ABSOLUTE MAXIMUM RATING

PARAMETER	SYMBOL	CONDITIONS	RATINGS	UNIT
Supply Voltage	V_{CC}		-0.5 ~ +6.5	V
Input Voltage	V_{IN}		-0.5 ~ +6.5	V
Output Voltage	V_{OUT}	Output in the high or low state	-0.5 ~ + $V_{CC}+0.5$	V
		Output in the power-off state	-0.5 ~ +6.5	V
Continuous V_{CC} or GND Current	I_{CC}		±100	mA
Continuous Output Current	I_{OUT}	$V_{OUT}=0V \sim V_{CC}$	±50	mA
Input Clamp Current	I_{IK}	$V_{IN}<0V$	-50	mA
Output Clamp Current	I_{OK}	$V_{OUT}>V_{CC}$ or $V_{OUT}<0V$	-50	mA
Junction Temperature	T_J		+150	°C
Storage Temperature Range	T_{STG}		-65 ~ +150	°C

Note: Absolute maximum ratings are those values beyond which the device could be permanently damaged. Absolute maximum ratings are stress ratings only and functional device operation is not implied.

■ THERMAL DATA

PARAMETER	SYMBOL	RATING	UNIT
Junction to Ambient	θ_{JA}	150	°C/W

■ RECOMMENDED OPERATING CONDITIONS

PARAMETER	SYMBOL	TEST CONDITIONS	MIN	TYP	MAX	UNIT
Supply Voltage	V_{CC}	Operating	1.65		5.5	V
		Data retention only	1.5			V
Input Voltage	V_{IN}		0		5.5	V
Output Voltage	V_{OUT}	High or low state	0		V_{CC}	V
Operating Temperature (Note)	T_A		-40		125	°C
Input Transition Rise or Fall Rate	$\Delta t/\Delta v$	$V_{CC}=1.8V\pm 0.15V, 2.5V\pm 0.2V$			20	ns/V
		$V_{CC}=3.3V\pm 0.3V$			10	ns/V
		$V_{CC}=5V\pm 0.5V$			5	ns/V

Note: This condition is only determined from design. It can't be 100% tested in mass production.

■ ELECTRICAL CHARACTERISTICS ($T_A = 25^\circ\text{C}$, unless otherwise specified)

PARAMETER	SYMBOL	TEST CONDITIONS	MIN	TYP	MAX	UNIT
Positive-Going Input Threshold Voltage	V_{T+}	$V_{CC}=1.65V$	0.7		1.4	V
		$V_{CC}=2.3V$	1		1.7	V
		$V_{CC}=3V$	1.3		2.2	V
		$V_{CC}=4.5V$	1.9		3.1	V
		$V_{CC}=5.5V$	2.2		3.7	V
Negative-Going Input Threshold Voltage	V_{T-}	$V_{CC}=1.65V$	0.3		0.7	V
		$V_{CC}=2.3V$	0.4		1.1	V
		$V_{CC}=3V$	0.6		1.3	V
		$V_{CC}=4.5V$	1.1		2	V
		$V_{CC}=5.5V$	1.4		2.5	V
Hysteresis Voltage ($V_{T+}-V_{T-}$)	ΔV_T	$V_{CC}=1.65V$	0.3		0.8	V
		$V_{CC}=2.3V$	0.4		0.9	V
		$V_{CC}=3V$	0.4		1.1	V
		$V_{CC}=4.5V$	0.6		1.3	V
		$V_{CC}=5.5V$	0.7		1.4	V

■ ELECTRICAL CHARACTERISTICS (Cont.)

PARAMETER	SYMBOL	TEST CONDITIONS	MIN	TYP	MAX	UNIT	
High-Level Output Voltage	V_{OH}	$V_{CC}=1.65 \sim 4.5V, I_{OH}=-100\mu A$	$V_{CC}-0.1$			V	
		$V_{CC}=1.65V, I_{OH}=-4mA$	1.2			V	
		$V_{CC}=2.3V, I_{OH}=-8mA$	1.9			V	
		$V_{CC}=3V$	$I_{OH}=-16mA$	2.4			V
			$I_{OH}=-24mA$	2.3			V
		$V_{CC}=4.5V, I_{OH}=-32mA$	3.8			V	
Low-Level Output Voltage	V_{OL}	$V_{CC}=1.65 \sim 4.5V, I_{OL}=100\mu A$			0.1	V	
		$V_{CC}=1.65V, I_{OL}=4mA$			0.45	V	
		$V_{CC}=2.3V, I_{OL}=8mA$			0.3	V	
		$V_{CC}=3V$	$I_{OL}=16mA$			0.4	V
			$I_{OL}=24mA$			0.55	V
		$V_{CC}=4.5V, I_{OL}=32mA$			0.55	V	
Input Leakage Current	$I_{I(LEAK)}$	$V_{CC}=0 \sim 5.5V, V_{IN}=5.5V$ or GND			± 5	μA	
Power OFF Leakage Current	I_{off}	$V_{CC}=0V, V_{IN}$ or $V_{OUT}=5.5V$			± 10	μA	
Quiescent Supply Current	I_{CC}	$V_{CC}=1.65 \sim 5.5V,$ $V_{IN}=V_{CC}$ or GND, $I_{OUT}=0A$			10	μA	
Additional Quiescent Supply Current Per Input Pin	ΔI_{CC}	$V_{CC}=3 \sim 5.5V,$ One input at $V_{CC}-0.6V,$ Other inputs at V_{CC} or GND			500	μA	
Input Capacitance	C_I	$V_{CC}=3.3V, V_{IN}=V_{CC}$ or GND		4.5		pF	

■ SWITCHING CHARACTERISTICS ($T_A=25^\circ C$, unless otherwise specified)

PARAMETER	SYMBOL	TEST CONDITIONS	MIN	TYP	MAX	UNIT
Propagation delay from input (A) to output(Y)	t_{PD}	$V_{CC}=1.8\pm 0.15V, C_L=30pF, R_L=1k\Omega$	3.9		9.2	ns
		$V_{CC}=2.5\pm 0.2V, C_L=30pF, R_L=500\Omega$	1.9		5.7	ns
		$V_{CC}=3.3\pm 0.3V, C_L=50pF, R_L=500\Omega$	2.3		5.4	ns
		$V_{CC}=5\pm 0.5V, C_L=50pF, R_L=500\Omega$	1.5		4.3	ns

■ OPERATING CHARACTERISTICS ($f=10MHz, T_A=25^\circ C$, unless otherwise specified)

PARAMETER	SYMBOL	TEST CONDITIONS	MIN	TYP	MAX	UNIT
Power Dissipation Capacitance	C_{PD}	$V_{CC}=1.8V$		17		pF
		$V_{CC}=2.5V$		18		pF
		$V_{CC}=3.3V$		19		pF
		$V_{CC}=5V$		22		pF

■ TEST CIRCUIT AND WAVEFORMS

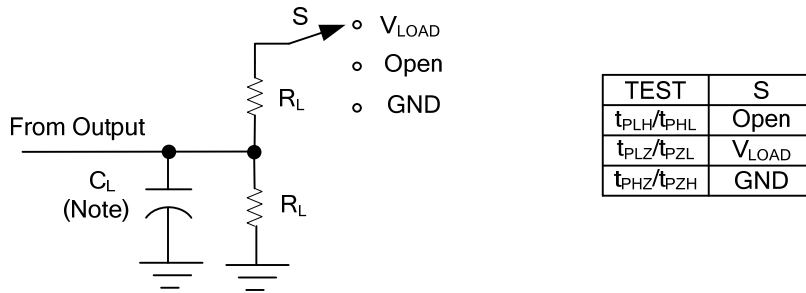

Note: C_L includes probe and jig capacitance.

V_{CC}	Inputs		V_M	V_{LOAD}	C_L	R_L	V_{Δ}
	V_{IN}	t_R, t_F					
$1.8V \pm 0.15V$	V_{CC}	$\leq 2ns$	$V_{CC}/2$	$2 \times V_{CC}$	30pF	1K Ω	0.15V
$2.5V \pm 0.2V$	V_{CC}	$\leq 2ns$	$V_{CC}/2$	$2 \times V_{CC}$	30pF	500 Ω	0.15V
$3.3V \pm 0.3V$	3V	$\leq 2.5ns$	1.5V	6V	50pF	500 Ω	0.3V
$5V \pm 0.5V$	V_{CC}	$\leq 2.5ns$	$V_{CC}/2$	$2 \times V_{CC}$	50pF	500 Ω	0.3V

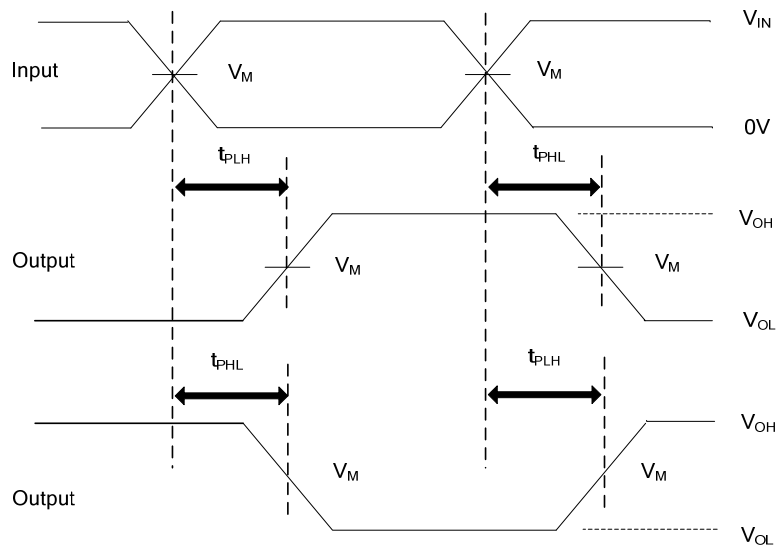

PROPAGATION DELAY TIMES

- Notes: 1. C_L includes probe and jig capacitance.
- 2. All input pulses are supplied by generators having the following characteristics: PRR $\leq 10MHz$, $Z_O = 50\Omega$.

UTC assumes no responsibility for equipment failures that result from using products at values that exceed, even momentarily, rated values (such as maximum ratings, operating condition ranges, or other parameters) listed in products specifications of any and all UTC products described or contained herein. UTC products are not designed for use in life support appliances, devices or systems where malfunction of these products can be reasonably expected to result in personal injury. Reproduction in whole or in part is prohibited without the prior written consent of the copyright owner. UTC reserves the right to make changes to information published in this document, including without limitation specifications and product descriptions, at any time and without notice. This document supersedes and replaces all information supplied prior to the publication hereof.