



## UK3919

Power MOSFET

### SWITCHING N-CHANNEL POWER MOSFET

#### DESCRIPTION

This **UK3919** N-Channel Logic Level MOSFET is produced using UTC Semiconductor advanced Power Trench process which has been tailored to make the on-state resistance minimum and yet maintain low gate charge for superior switching performance especially.

The **UK3919** is well suited for where low in-line power loss is needed in a very small outline surface mount package, such as low voltage and battery powered applications.

#### FEATURES

- \*  $R_{DS(ON)} = 5.6m\Omega @ V_{GS} = 10 V$
- \* Low capacitance
- \* Optimized gate charge
- \* Fast switching capability
- \* Avalanche energy specified

#### SYMBOL

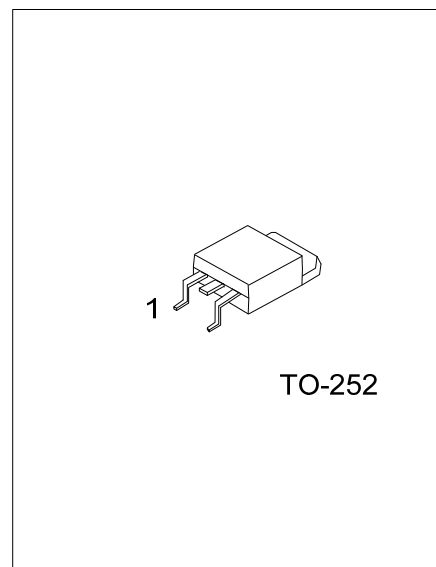
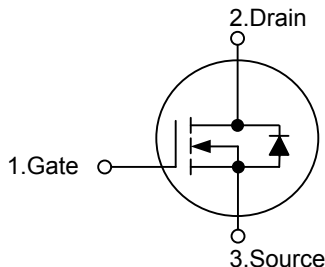

TO-252

\*Pb-free plating product number:UK3919L

#### ORDERING INFORMATION

Ordering Number		Package	Pin Assignment			Packing
Normal	Lead Free Plating		1	2	3	
UK3919-TN3-R	UK3919L-TN3-R	TO-252	G	D	S	Tape Reel
UK3919-TN3-T	UK3919L-TN3-T	TO-252	G	D	S	Tube

UK3919L-TN3-R	(1)Packing Type	(1) R: Tape Reel, T: Tube
	(2)Package Type	(2) TN3:TO-252
	(3)Lead Plating	(3) L: Lead Free Plating, Blank: Pb/Sn

■ ABSOLUTE MAXIMUM RATINGS ( $T_C = 25^\circ\text{C}$ , unless otherwise specified)

PARAMETER	SYMBOL	RATINGS	UNIT
Drain to Source Voltage	$V_{DS}$	25	V
Gate to Source Voltage	$V_{GS}$	$\pm 20$	V
Continuous Drain Current	$I_D$	$\pm 64$	A
Pulsed Drain Current (Note1)	$I_{DM}$	$\pm 256$	A
Single Avalanche Current (Note2)	$I_{AS}$	27	A
Single Avalanche Energy (Note2)	$E_{AS}$	73	mJ
Total Power Dissipation	$P_D$	36	W
Storage Temperature	$T_{STG}$	-55 ~ +150	$^\circ\text{C}$

Note: Absolute maximum ratings are those values beyond which the device could be permanently damaged.

Absolute maximum ratings are stress ratings only and functional device operation is not implied.

■ ELECTRICAL CHARACTERISTICS ( $T_C = 25^\circ\text{C}$ , unless otherwise specified)

PARAMETER	SYMBOL	TEST CONDITIONS	MIN	TYP	MAX	UNIT
<b>OFF CHARACTERISTICS</b>						
Zero Gate Voltage Drain Current	$I_{DSS}$	$V_{DS} = 25\text{ V}, V_{GS} = 0\text{ V}$			10	$\mu\text{A}$
Gate-Body Leakage Current	$I_{GSS}$	$V_{DS} = 0\text{ V}, V_{GS} = \pm 20\text{ V}$			$\pm 100$	nA
<b>ON CHARACTERISTICS</b>						
Gate-Threshold Voltage	$V_{GS(OFF)}$	$V_{DS} = 10\text{ V}, I_D = 1\text{ mA}$	2.0	2.5	3.0	V
Drain-Source On-Resistance	$R_{DS(ON)}$	$V_{GS} = 10\text{ V}, I_D = 32\text{ A}$		4.5	5.6	m $\Omega$
		$V_{GS} = 5.0\text{ V}, I_D = 16\text{ A}$		6.8	13.7	
<b>DYNAMIC PARAMETERS</b>						
Input Capacitance	$C_{ISS}$	$V_{DS} = 10\text{ V}, V_{GS} = 0\text{ V}, f = 1\text{ MHz}$		2050		pF
Output Capacitance	$C_{OSS}$			460		
Reverse Transfer Capacitance	$C_{RSS}$			330		
<b>SWITCHING PARAMETERS</b>						
Gate to Source Charge	$Q_G$	$V_{DD} = 20\text{ V}, V_{GS} = 10\text{ V}, I_D = 64\text{ A}$		42		nC
Gate Charge at Threshold	$Q_{GS}$			8		
Gate to Drain Charge	$Q_{GD}$			15		
Turn-ON Delay Time	$t_{D(ON)}$	$V_{DD} = 12.5\text{ V}, I_D = 32\text{ A}, V_{GS} = 10\text{ V}, R_G = 10\ \Omega$		16		ns
Turn-ON Rise Time	$t_R$			19		
Turn-OFF Delay Time	$t_{D(OFF)}$			53		
Turn-OFF Fall-Time	$t_F$			22		
<b>SOURCE- DRAIN DIODE RATINGS AND CHARACTERISTICS</b>						
Body Diode Forward Voltage	$V_{SD}$	$I_F = 64\text{ A}, V_{GS} = 0\text{ V}$		0.97		V
Reverse Recovery Time	$t_{RR}$	$I_F = 64\text{ A}, V_{GS} = 0\text{ V}, di/dt = 100\text{ A}/\mu\text{s}$		23		ns
Reverse Recovery Charge	$Q_{RR}$			11		nC

Notes: 1.  $PW \leq 10\ \mu\text{s}$ , Duty Cycle  $\leq 1\%$

2. Starting  $T_{CH} = 25^\circ\text{C}$ ,  $V_{DD} = 12.5\text{ V}$ ,  $R_G = 25\ \Omega$ ,  $V_{GS} = 20 \rightarrow 0\text{ V}$

## TYPICAL CHARACTERISTICS

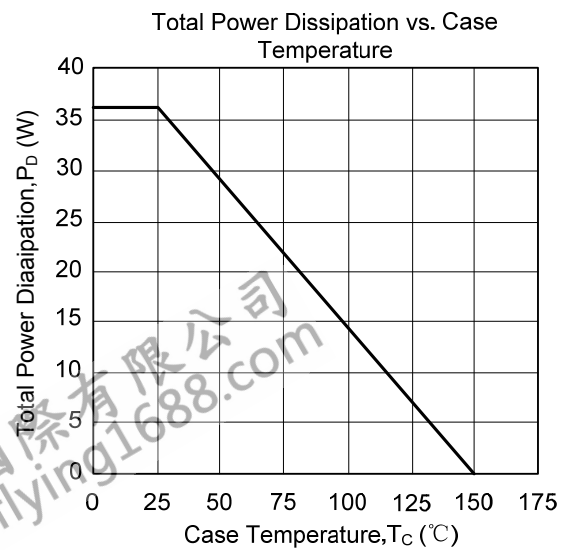
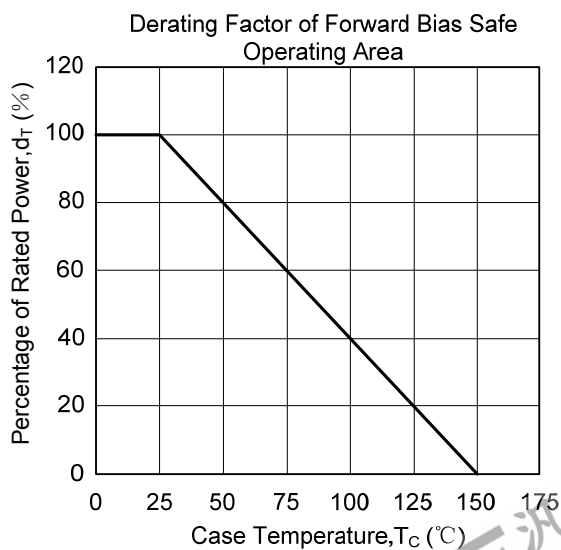
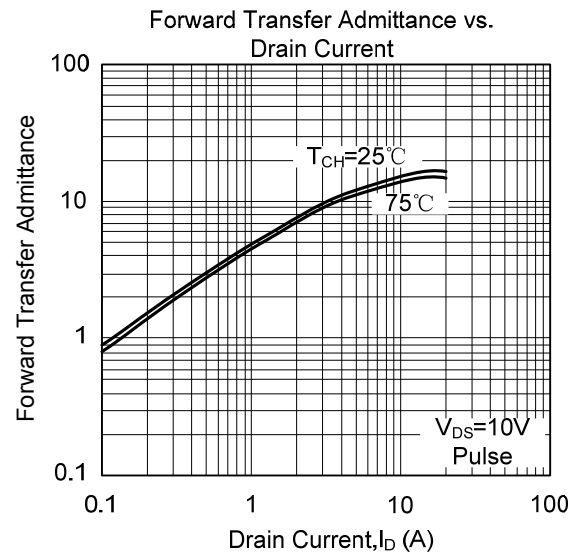
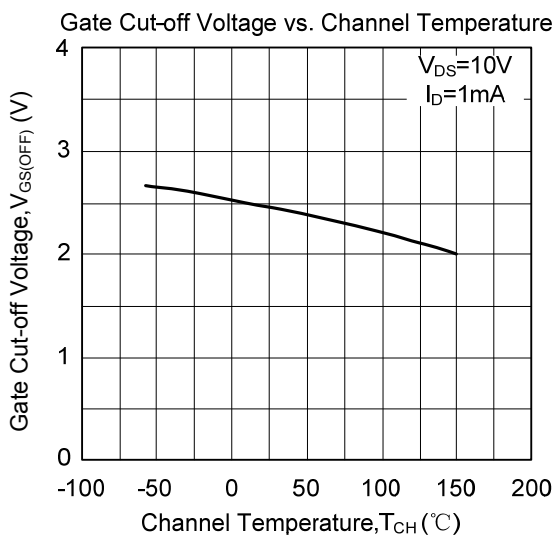
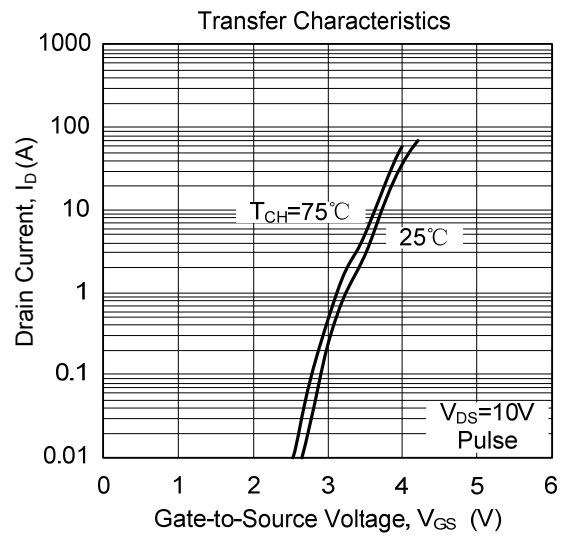
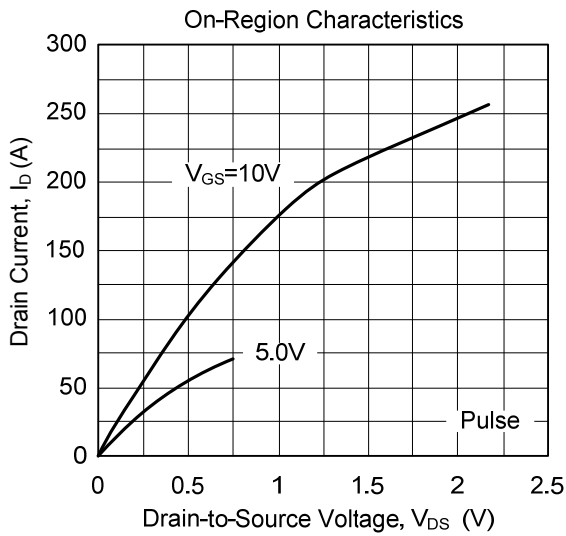

■ TYPICAL CHARACTERISTICS(Cont.)

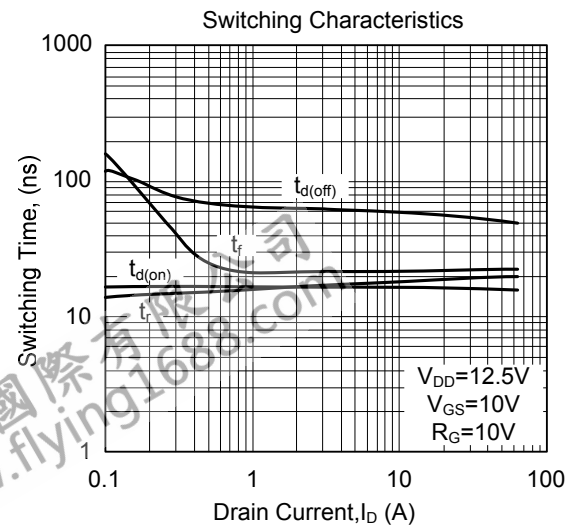
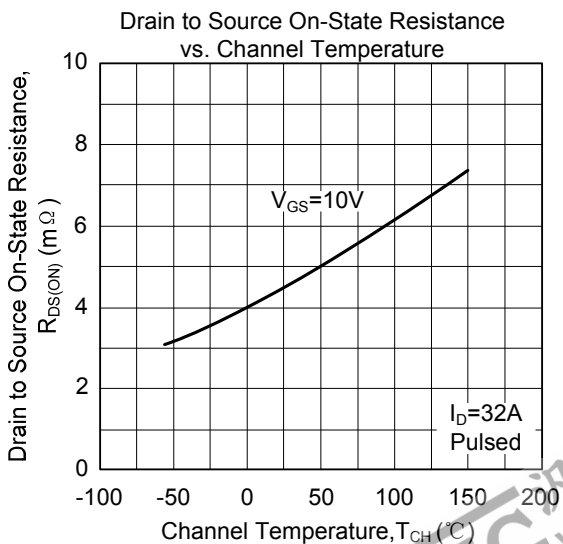
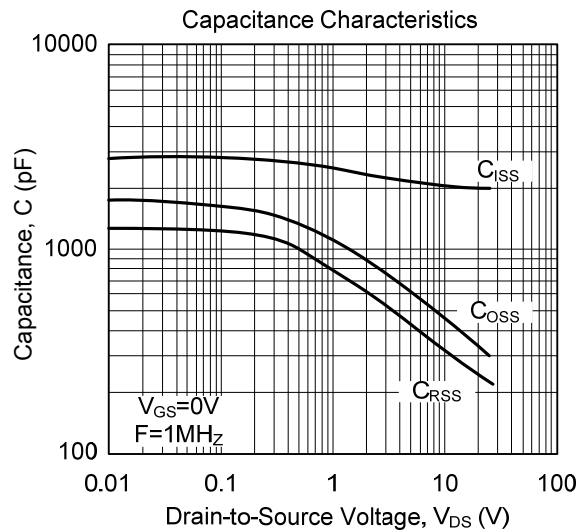
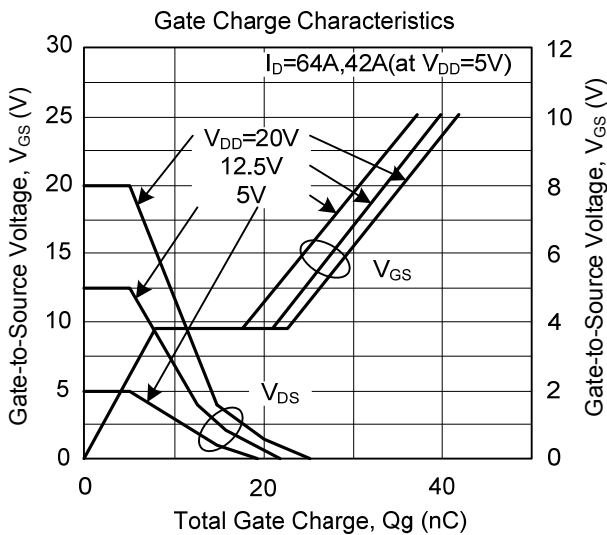
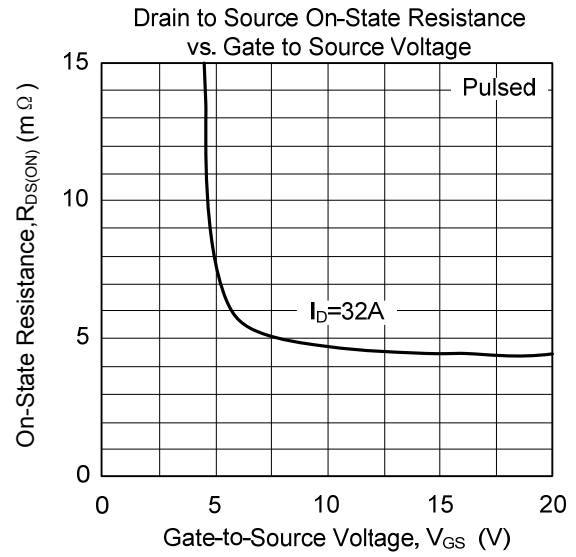
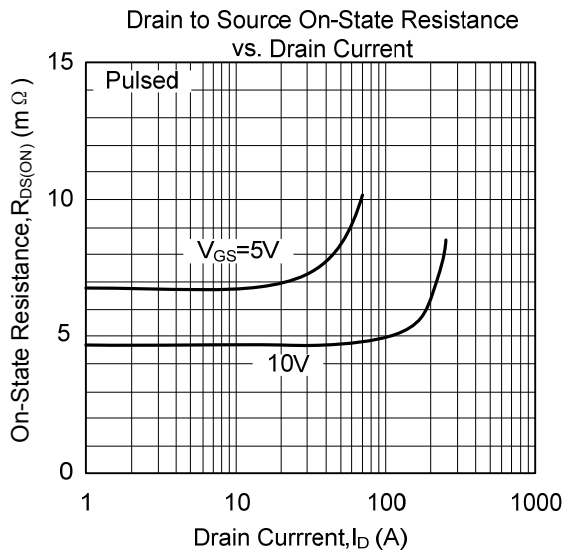

## TYPICAL CHARACTERISTICS(Cont.)

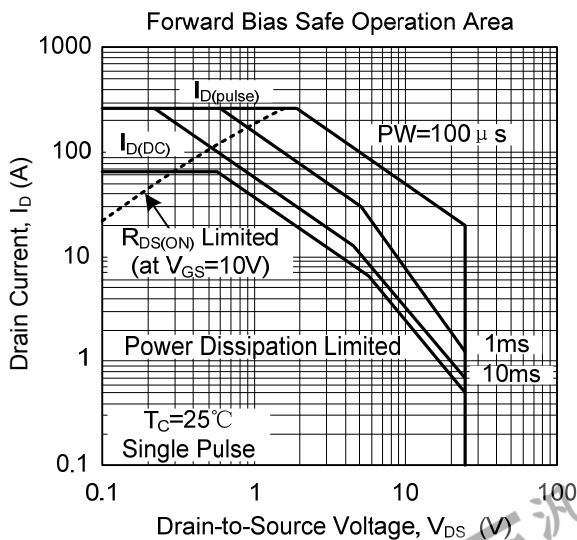
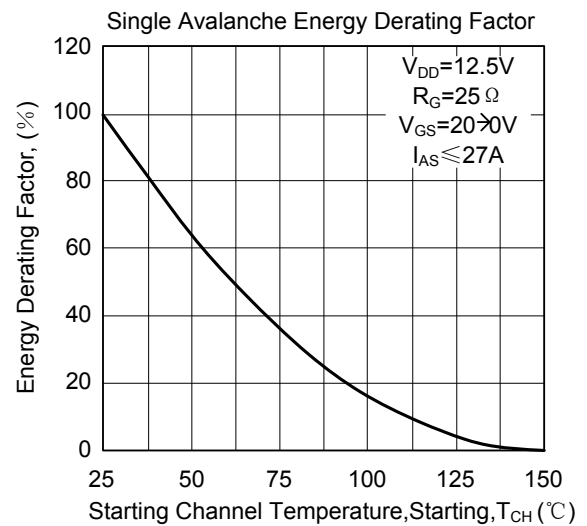
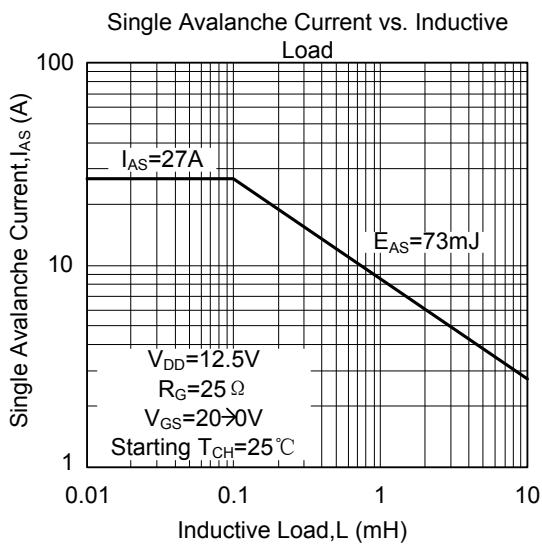
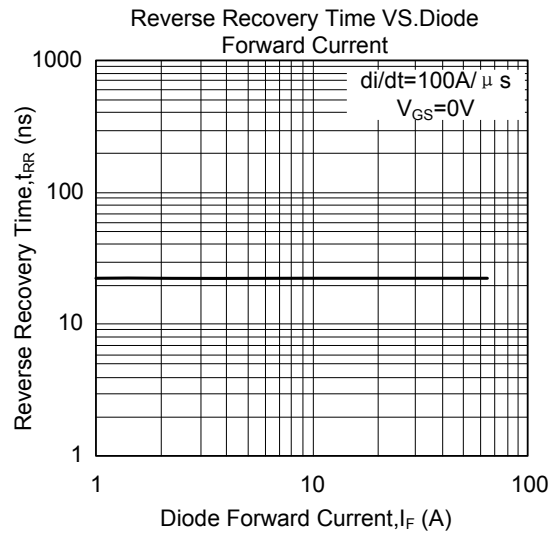
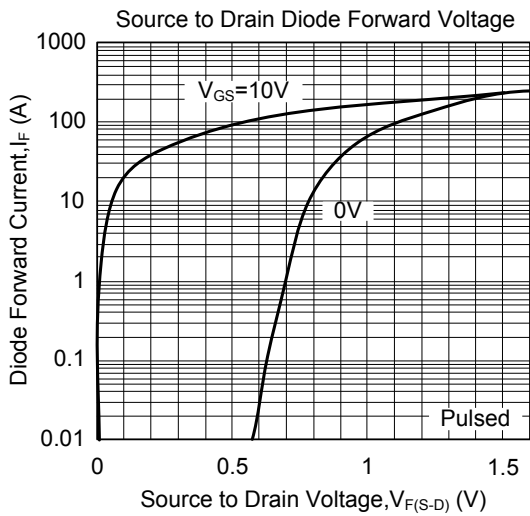

■ TYPICAL CHARACTERISTICS(Cont.)

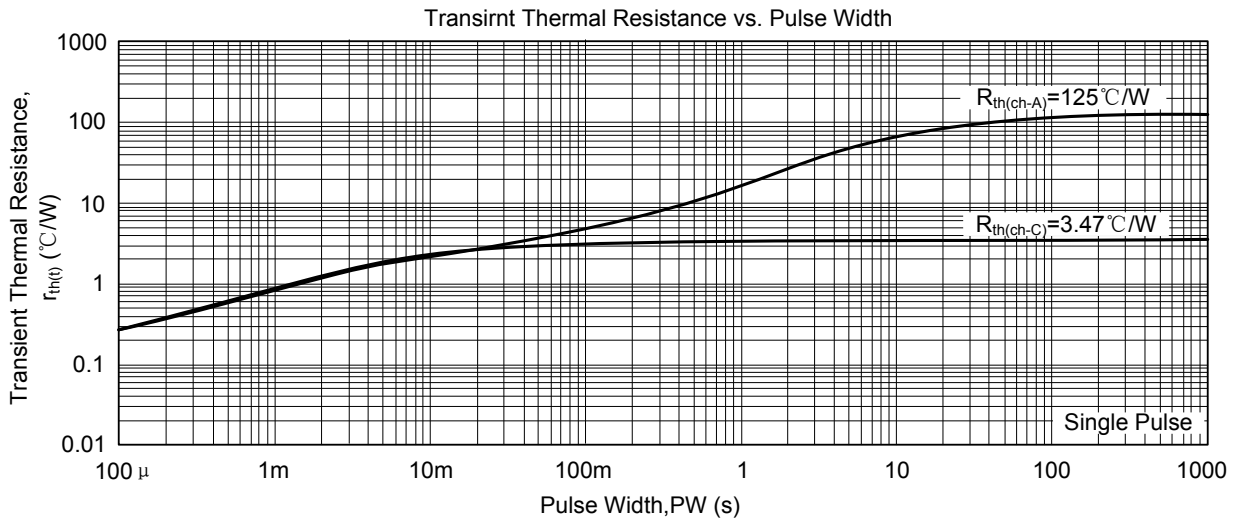

UTC assumes no responsibility for equipment failures that result from using products at values that exceed, even momentarily, rated values (such as maximum ratings, operating condition ranges, or other parameters) listed in products specifications of any and all UTC products described or contained herein. UTC products are not designed for use in life support appliances, devices or systems where malfunction of these products can be reasonably expected to result in personal injury. Reproduction in whole or in part is prohibited without the prior written consent of the copyright owner. The information presented in this document does not form part of any quotation or contract, is believed to be accurate and reliable and may be changed without notice.