



US2236060B

Preliminary

LINEAR INTEGRATED CIRCUIT

ULTRA-SMALL, LOW-INPUT VOLTAGE, LOW R_{ON} LOAD SWITCH

DESCRIPTION

The UTC **US2236060B** is an ultra-small, low R_{ON} load switch with controlled turn on. The device contains a P-channel MOSFET that operates over an input voltage range of 1.1 V to 3.6 V. The switch is controlled by an on/off input (ON), which is capable of interfacing directly with low-voltage control signals.

FEATURES

- * Low Input Voltage: 1.1V~3.6V
- * Ultra-Low On-State Resistance (R_{ON})
- * Typical R_{ON} values
 - R_{ON} =44m Ω at V_{IN} =3.6V
 - R_{ON} =50m Ω at V_{IN} =2.5V
 - R_{ON} =58m Ω at V_{IN} =1.8V
 - R_{ON} =83m Ω at V_{IN} =1.2V
- * 1A Maximum Continuous Switch Current
- * Maximum Quiescent Current < 1 μ A
- * Maximum Shutdown Current < 1 μ A
- * Low Control Input Thresholds Enable Use of Low-Voltage Logic
- * Controlled Slew Rate to Avoid Inrush Currents

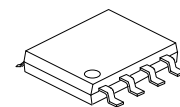

SOP-8

ORDERING INFORMATION

Ordering Number		Package	Packing
Lead Free	Halogen Free		
US2236060BL-S08-R	US2236060BG-S08-R	SOP-8	Tape Reel

<p>US2236060BG-S08-R</p> <ul style="list-style-type: none"> (1)Packing Type (2)Package Type (3)Green Package 	<ul style="list-style-type: none"> (1) R: Tape Reel (2) S08: SOP-8 (3) G: Halogen Free and Lead Free, L: Lead Free
---	---

MARKING

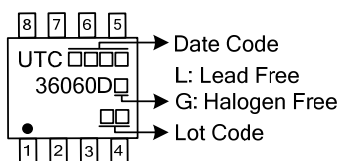

■ PIN CONFIGURATION

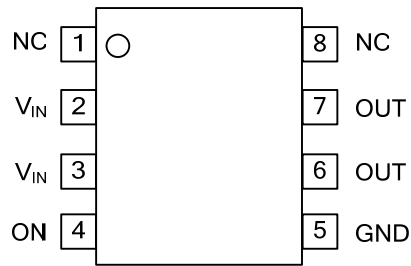

■ PIN DESCRIPTION

PIN NO.	PIN NAME	DESCRIPTION
1, 8	NC	
2, 3	V _{IN}	Switch input, bypass this input with a ceramic capacitor to ground
4	ON	Switch control input, active high
5	GND	Ground
6, 7	V _{OUT}	Switch output

■ BLOCK DIAGRAM

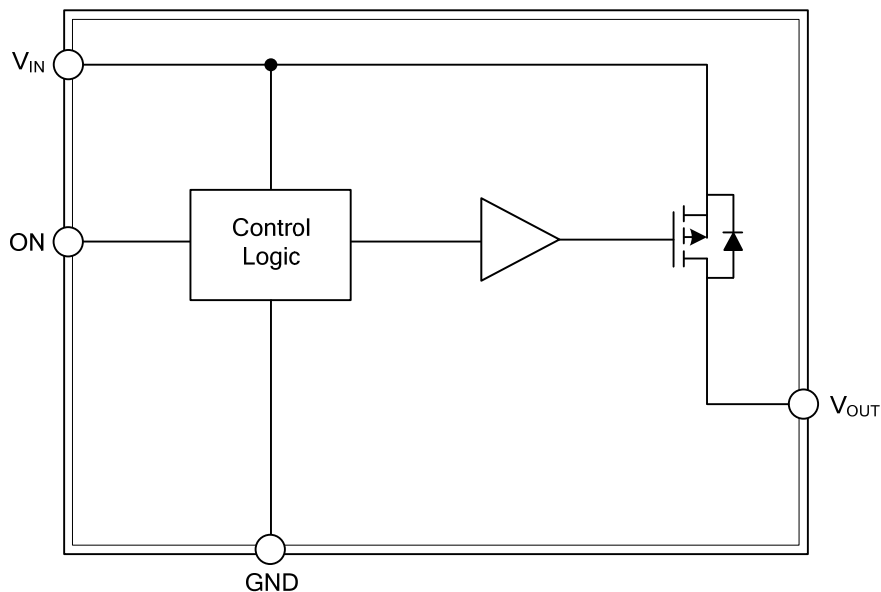

FUNCTION TABLE

ON (Control Input)	V _{IN} to V _{OUT}
L	OFF
H	ON

■ ABSOLUTE MAXIMUM RATING

PARAMETER	SYMBOL	RATINGS	UNIT
Input Voltage Range	V_{IN}	4	V
Output Voltage Range	V_{OUT}	$V_{IN} + 0.3$	V
Input Voltage Range	V_{ON}	4	V
Maximum Continuous Switch Current, $T_A = -40^{\circ}\text{C} \sim 85^{\circ}\text{C}$	I_{MAX}	1	A
Maximum Pulsed Current (100- μs Pulse, 2% Duty Cycle), $T_A = -40^{\circ}\text{C} \sim 85^{\circ}\text{C}$	I_{PLS}	2.7	A
Power Dissipation at $T_A = 25^{\circ}\text{C}$	P_D	0.48	W
Maximum junction Temperature	T_J	+125	$^{\circ}\text{C}$
Operating Temperature Range	T_{OPR}	-40 ~ +85	$^{\circ}\text{C}$
Storage Temperature Range	T_{STG}	-65 ~ +150	$^{\circ}\text{C}$

Note: Absolute maximum ratings are those values beyond which the device could be permanently damaged. Absolute maximum ratings are stress ratings only and functional device operation is not implied.

■ THERMAL DATA

PARAMETER	SYMBOL	RATINGS	UNIT
Junction to Ambient	θ_{JA}	205	$^{\circ}\text{C}/\text{W}$

■ RECOMMENDED OPERATING CONDITIONS

PARAMETER	SYMBOL	MIN	TYP	MAX	UNIT
Input Voltage Range	V_{IN}	1.1		3.6	V
Output Voltage Range	V_{OUT}			V_{IN}	V
High-Level Input Voltage, ON	V_{IH}	0.85		3.6	V
Low-Level Input Voltage, ON	V_{IL}			0.4	V
Input Capacitor	C_{IN}	1			μF

■ ELECTRICAL CHARACTERISTICS

(Unless otherwise noted, the specification applies over the operating ambient temperature $T_A = 25^{\circ}\text{C}$ and $V_{IN} = 1.1\text{V} \sim 3.6\text{V}$. Typical values are for $V_{IN} = 3.6\text{V}$ and $T_A = 25^{\circ}\text{C}$)

PARAMETER	SYMBOL	TEST CONDITIONS	MIN	TYP	MAX	UNIT
Quiescent Current	I_{IN}	$I_{OUT} = 0\text{mA}$, $V_{IN} = V_{ON}$		0.07	1	μA
Off Supply Current	$I_{IN(OFF)}$	$V_{ON} = 0\text{V}$, $OUT = \text{Open}$		0.05	1	μA
Leakage Current	$I_{IN(LEAKAGE)}$	$V_{ON} = 0\text{V}$, $V_{OUT} = 0\text{V}$		0.05	1	μA
ON-State Resistance	R_{ON}	$I_{OUT} = -200\text{mA}$	$V_{IN} = 3.6\text{V}$	44	60	$\text{m}\Omega$
			$V_{IN} = 2.5\text{V}$	50	63	$\text{m}\Omega$
			$V_{IN} = 1.8\text{V}$	58	72	$\text{m}\Omega$
			$V_{IN} = 1.2\text{V}$	83	106	$\text{m}\Omega$
			$V_{IN} = 1.1\text{V}$	97	125	$\text{m}\Omega$
ON Input Leakage Current	I_{ON}	$V_{ON} = 1.1\text{V} \sim 3.6\text{V}$ or 0V		0.005	1	μA

■ SWITCHING CHARACTERISTICS ($V_{IN} = 3.6\text{V}$, $T_A = 25^{\circ}\text{C}$, unless otherwise specified)

PARAMETER	SYMBOL	TEST CONDITIONS	MIN	TYP	MAX	UNIT
Turn-ON Time	t_{ON}	$R_L = 500\Omega$, $C_L = 0.1\mu\text{F}$		28		μs
Turn-OFF Time	t_{OFF}	$R_L = 500\Omega$, $C_L = 0.1\mu\text{F}$		55		μs
V_{OUT} Rise Time	t_r	$R_L = 500\Omega$, $C_L = 0.1\mu\text{F}$		25		μs
V_{OUT} Fall Time	t_f	$R_L = 500\Omega$, $C_L = 0.1\mu\text{F}$		116		μs

■ APPLICATION INFORMATION**ON/OFF Control**

The ON pin controls the state of the switch. Asserting ON high enables the switch. ON is active high and has a low threshold, making it capable of interfacing with low-voltage signals. The ON pin is compatible with standard GPIO logic threshold. It can be used with any microcontroller with 1.2V, 1.8V, 2.5V, or 3.3V GPIOs.

Input Capacitor

To limit the voltage drop on the input supply caused by transient inrush currents when the switch turns on into a discharged load capacitor or short-circuit, a capacitor needs to be placed between V_{IN} and GND. A 1- μ F ceramic capacitor, C_{IN} , placed close to the pins is usually sufficient. Higher values of C_{IN} can be used to further reduce the voltage drop during high-current application. When switching heavy loads, it is recommended to have an input capacitor approximately ten times higher than the output capacitor to avoid excessive voltage drop.

Output Capacitor

Due to the integrated body diode in the PMOS switch, a C_{IN} greater than C_L is highly recommended. A C_L greater than C_{IN} can cause V_{OUT} to exceed V_{IN} when the system supply is removed. This could result in current flow through the body diode from V_{OUT} to V_{IN} . A C_{IN} to C_L ratio of at least 10 to 1 is recommended for minimizing V_{IN} dip caused by inrush currents during startup; however, a 10 to 1 ratio for capacitance is not required for proper functionality of the device. A ratio smaller than 10 to 1 (such as 1 to 1) could cause slightly more V_{IN} dip at turn on due to inrush currents.

Board Layout

For best performance, all traces should be as short as possible. To be most effective, the input and output capacitors should be placed close to the device to minimize the effects that parasitic trace inductances may have on normal operation. Using wide traces for V_{IN} , V_{OUT} , and GND helps minimize the parasitic electrical effects along with minimizing the case to ambient thermal impedance.

■ TEST CIRCUIT AND t_{ON}/t_{OFF} WAVEFORMS

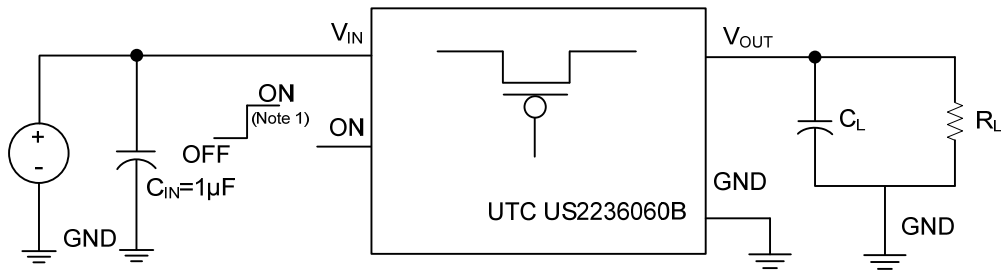

Note 1: Control signal rise and fall times are 100ns.

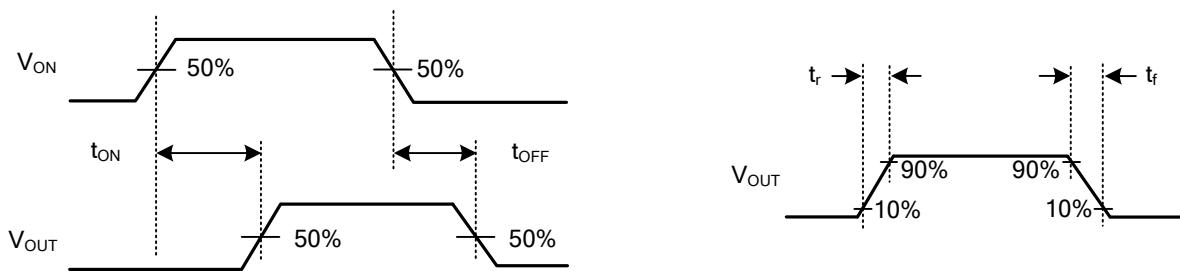

t_{ON}/t_{OFF} WAVEFORMS

■ TYPICAL APPLICATION CIRCUIT

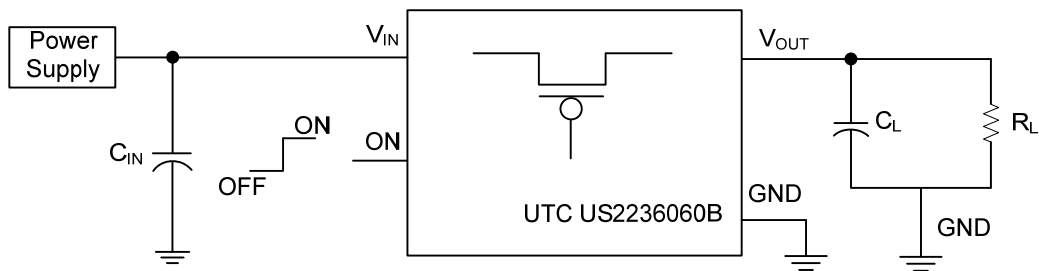

UTC assumes no responsibility for equipment failures that result from using products at values that exceed, even momentarily, rated values (such as maximum ratings, operating condition ranges, or other parameters) listed in products specifications of any and all UTC products described or contained herein. UTC products are not designed for use in life support appliances, devices or systems where malfunction of these products can be reasonably expected to result in personal injury. Reproduction in whole or in part is prohibited without the prior written consent of the copyright owner. The information presented in this document does not form part of any quotation or contract, is believed to be accurate and reliable and may be changed without notice.