



UT131

TRIAC

TRIAC LOGIC LEVEL

■ **DESCRIPTION**

Passivated, sensitive gate triac in a plastic envelope, intended for use in general purpose bidirectional switching and phase control applications. These devices are intended to be interfaced directly to microcontrollers. Logic integrated circuits and other low power gate trigger circuits.

■ **SYMBOL**

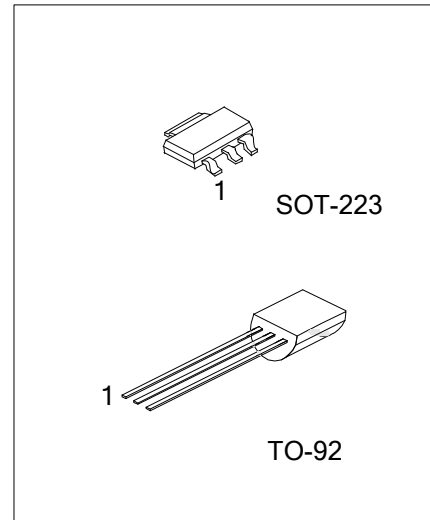
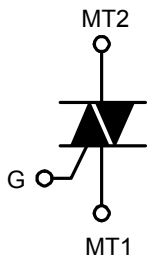

■ **ORDERING INFORMATION**

Ordering Number		Package	Pin Assignment			Packing
Lead Free	Halogen Free		1	2	3	
-	UT131G-x-AA3-R	SOT-223	MT1	MT2	GATE	Tape Reel
UT131L-x-T92-B	UT131G -x-T92-B	TO-92	MT1	GATE	MT2	Tape Box
UT131L-x-T92-K	UT131G -x-T92-K	TO-92	MT1	GATE	MT2	Bulk

<p>UT131G-x-AA3-R</p> <ul style="list-style-type: none"> (1) Packing Type (2) Package Type (3) Peak Voltage (4) Green Package 	<ul style="list-style-type: none"> (1) B: Tape Reel, K: Bulk, R: Tape Reel (2) AA3: SOT-223, T92: TO-92 (3) 5: 500V, 6: 600V, 8: 800V (4) G: Halogen Free and Lead Free, L: Lead Free
---	---

■ **MARKING**

SOT-223	TO-92

■ ABSOLUTE MAXIMUM RATINGS

PARAMETER		SYMBOL	RATINGS	UNIT
Repetitive Peak Off-State Voltage (Note 2)	UT131-5	V_{DRM}	500	V
	UT131-6		600	V
	UT131-8		800	V
RMS On-State Current, Full Sine Wave; $T_{lead} \leq 51^\circ C$		$I_{T(RMS)}$	1	A
Non-Repetitive Peak On-State Current (Full Sine Wave; $T_J = 25^\circ C$ Prior to Surge)	$t = 20ms$	I_{TSM}	16	A
	$t = 16.7ms$		17.6	A
Circuit Fusing	$t = 10ms$	I_t^2	1.28	A^2s
Repetitive Rate of Rise of On-State Current after Triggering $I_{TM} = 1.5A, I_G = 0.2A, dI_G/dt = 0.2A/\mu s$	T2 + G +	di_T/dt	50	$A/\mu s$
	T2 + G -		50	$A/\mu s$
	T2 - G -		50	$A/\mu s$
	T2 - G +		10	$A/\mu s$
Peak Gate Voltage		V_{GM}	5	V
Peak Gate Current		I_{GM}	2	A
Peak Gate Power		P_{GM}	5	W
Average Gate Power (over any 20ms period)		$P_{G(AV)}$	0.5	W
Junction Temperature		T_J	+125	$^\circ C$
Storage Temperature		T_{STG}	-40 ~ +150	$^\circ C$

Notes: 1. Absolute maximum ratings are those values beyond which the device could be permanently damaged. Absolute maximum ratings are stress ratings only and functional device operation is not implied.

2. Although not recommended, off-state voltages up to 800V may be applied without damage, but the triac may switch to the on-state. The rate of rise of current should not exceed 3 A/ μs .

■ THERMAL DATA

PARAMETER		SYMBOL	RATINGS	UNIT
Junction to Lead	Full Cycle	θ_{JLEAD}	60	K/W
	Half Cycle		80	K/W
Junction to Ambient (Note)		θ_{JA}	150	K/W

Note: PCB mounted; lead length=4mm

■ ELECTRICAL CHARACTERISTICS ($T_J = 25^\circ C$, unless otherwise specified)

PARAMETER	SYMBOL	TEST CONDITIONS	MIN	TYP	MAX	UNIT	
Gate Trigger Current	I_{GT}	$V_D = 12V, I_T = 0.1A$	T2 + G +		0.4	3	mA
			T2 + G -		1.3	3	mA
			T2 - G -		1.4	5	mA
			T2 - G +		3.8	7	mA
Latching Current	I_L	$V_D = 12V, I_{GT} = 0.1A$	T2 + G +		1.2	5	mA
			T2 + G -		4.0	8	mA
			T2 - G -		1.0	5	mA
			T2 - G +		2.5	8	mA
Holding Current	I_H	$V_D = 12V, I_{GT} = 0.1A$		1.3	5	mA	
On -State Voltage	V_T	$I_T = 2.0A$		1.2	1.5	V	
Gate Trigger Voltage	V_{GT}	$V_D = 12V, I_T = 0.1A$		0.7	1.5	V	
		$V_D = 400V, I_T = 0.1A, T_J = 125^\circ C$	0.2	0.3		V	
Off-State Leakage Current	I_D	$V_D = V_{DRM(MAX)}, T_J = 125^\circ C$		0.1	0.5	mA	

■ DYNAMIC CHARACTERISTICS ($T_J = 25^\circ C$, unless otherwise specified)

PARAMETER	SYMBOL	TEST CONDITIONS	MIN	TYP	MAX	UNIT
Critical Rate of Rise of off-state Voltage	dV_D/dt	$V_{DM} = 67\% V_{DRM(MAX)}, T_J = 125^\circ C$ Exponential waveform, $R_{GK} = 1k\Omega$	5	15		V/ μs
Gate Controlled Turn-on Time	t_{GT}	$I_{TM} = 1.5A, V_D = V_{DRM(MAX)}, I_G = 0.1A, dI_G/dt = 5A/\mu s$		2		μs

■ TYPICAL CHARACTERISTICS

Maximum on-state Dissipation vs. RMS On-state Current, $I_{T(RMS)}$, Where α = conduction Angle

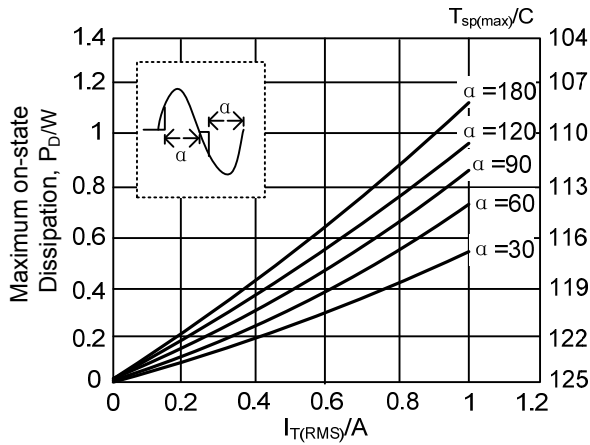

Maximum Permissible Non-repetitive Peak On-state Current vs. Pulse Width t_p , for Sinusoidal Currents, $t_p \leq 20ms$

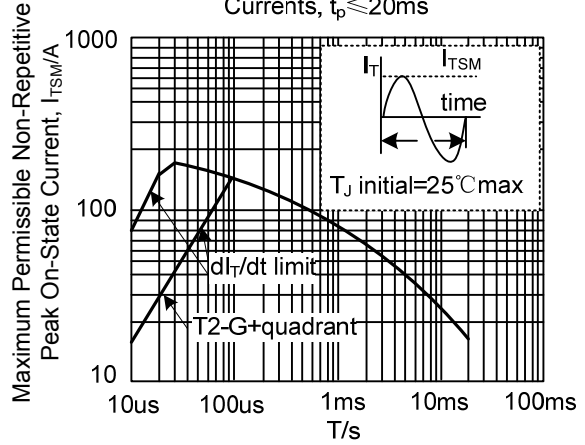

Maximum Permissible Non-Repetitive Peak On-State Current vs. Number of Cycles, for Sinusoidal Currents

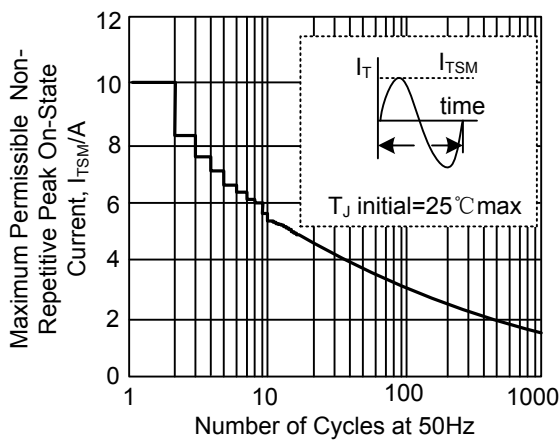

Maximum Permissible RMS Current $I_{T(RMS)}$ vs. Lead Temperature

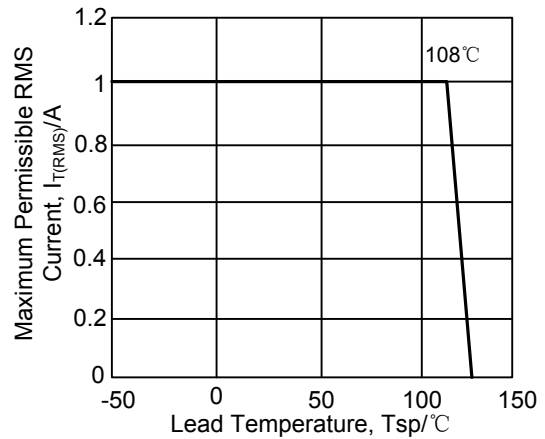

Maximum Permissible Repetitive RMS on-state Current vs. Surge Duration, for Sinusoidal Currents, $f=50Hz$; $T_{lead} \leq 51^\circ C$

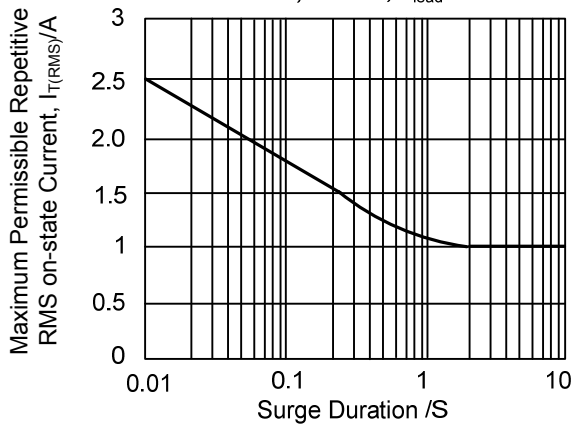

Normalised Gate Trigger Voltage vs. Junction Temperature

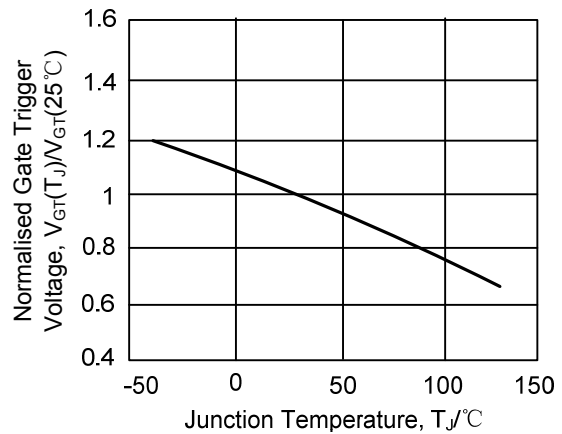

■ TYPICAL CHARACTERISTICS(Cont.)

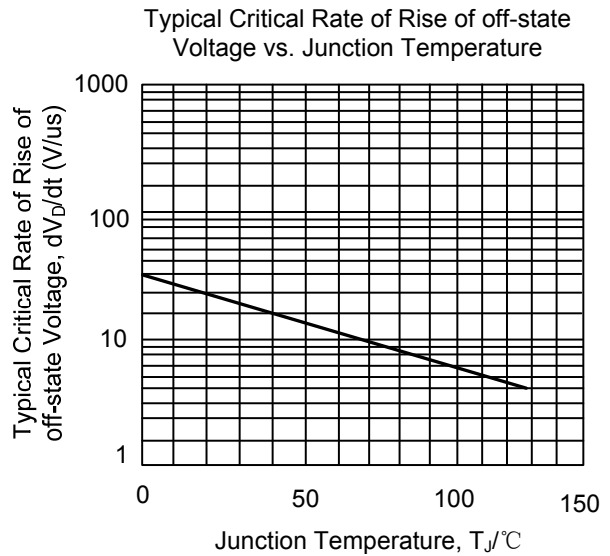
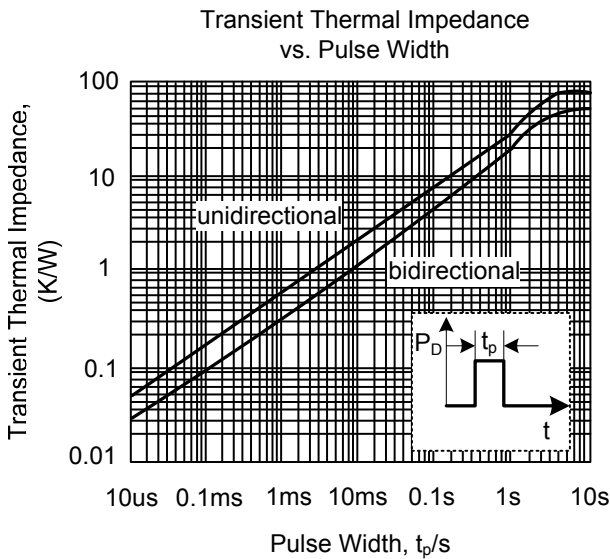
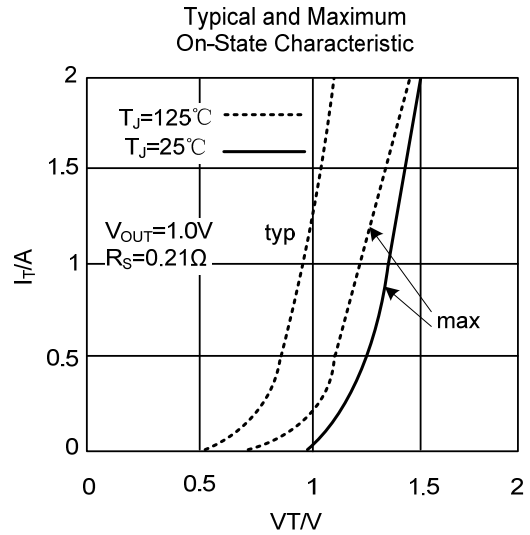
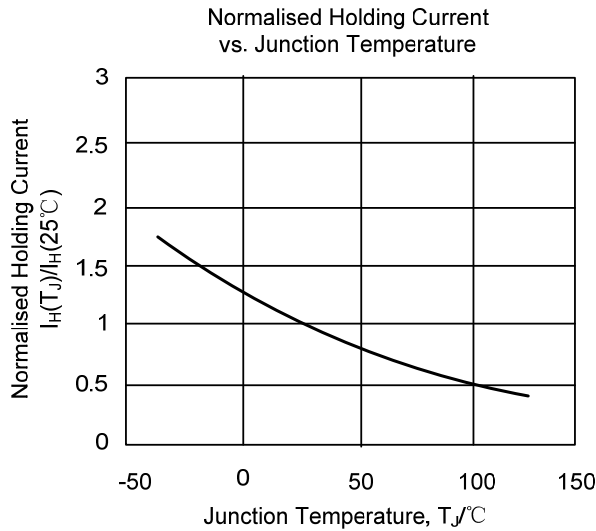
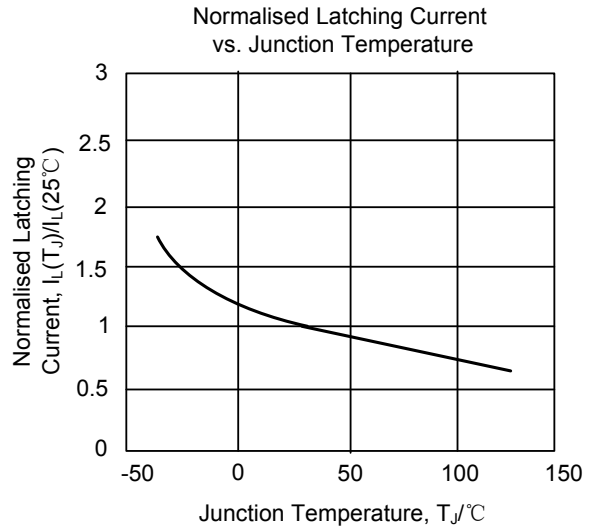
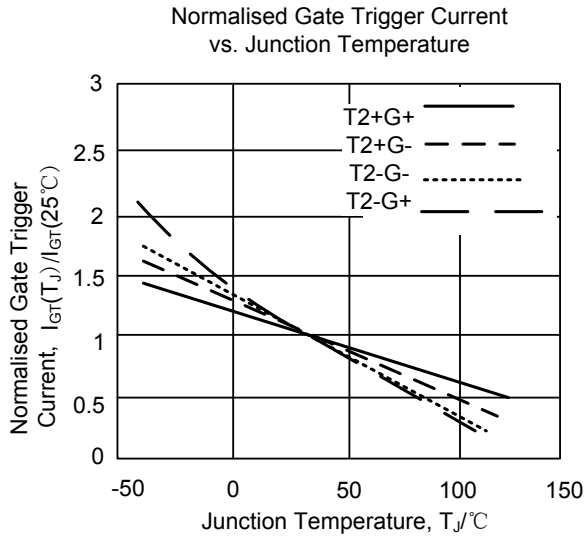

UTC assumes no responsibility for equipment failures that result from using products at values that exceed, even momentarily, rated values (such as maximum ratings, operating condition ranges, or other parameters) listed in products specifications of any and all UTC products described or contained herein. UTC products are not designed for use in life support appliances, devices or systems where malfunction of these products can be reasonably expected to result in personal injury. Reproduction in whole or in part is prohibited without the prior written consent of the copyright owner. The information presented in this document does not form part of any quotation or contract, is believed to be accurate and reliable and may be changed without notice.