



UT138E

TRIAC

TRIAC

■ DESCRIPTION

Glass passivated , sensitive gate triac in a plastic envelope, intended for use in general purpose bidirectional switching and phase control applications, where high sensitivity is required in all four quadrants.

■ SYMBOL

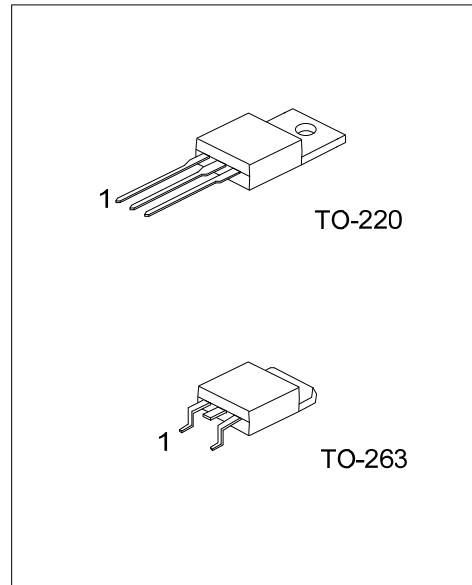
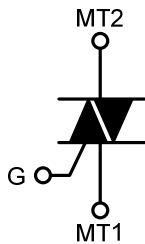

■ ORDERING INFORMATION

Ordering Number		Package	Pin Assignment			Packing
Lead Free	Halogen Free		1	2	3	
UT138EL-x-TA3-T	UT138EG-x-TA3-T	TO-220	MT1	MT2	G	Tube
UT138EL-x-TQ2-T	UT138EG-x-TQ2-T	TO-263	MT1	MT2	G	Tube
UT138EL-x-TQ2-R	UT138EG-x-TQ2-R	TO-263	MT1	MT2	G	Tape Reel

<p>UT138EG-x-TA3-T</p> <p>(1)Packing Type (2)Package Type (3)Voltage (4)Green Package</p>	<p>(1) T: Tube, R: Tape Reel (2) TA3: TO-220, TQ2: TO-263 (3) 5: 500V, 6: 600V, 8: 800V (4) G: Halogen Free and Lead Free, L: Lead Free</p>
---	---

■ MARKING

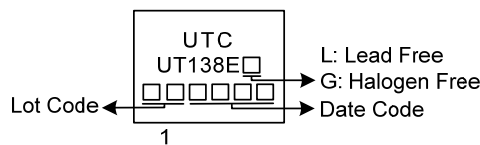

■ ABSOLUTE MAXIMUM RATING (T_J=25°C)

PARAMETER	SYMBOL	RATINGS	UNIT
Repetitive Peak Off State Voltag	UT138E-5	500	V
	UT138E-6	600	V
	UT138E-8	800	V
RMS On-state Current (Full sine wave, T _{MB} ≤99°C)	I _{T(RMS)}	12	A
Non-Repetitive Peak. On-State Current (Full sine wave, T _J =25°C prior to surge)	t=20mS	95	A
	t=16.7mS	105	A
I ² t For Fusing (t=10ms)	I ² t	45	A ² s
Repetitive Rate of Rise of On-state Current After Triggering (I _{TM} =20A, I _G =0.2A, dI _G /dt=0.2A/μs)	T2+ G+	50	A/μs
	T2+ G-	50	A/μs
	T2- G-	50	A/μs
	T2- G+	10	A/μs
Peak Gate Voltage	V _{GM}	5	V
Peak Gate Current	I _{GM}	2	A
Peak Gate Power	P _{GM}	5	W
Average Gate Power (Over any 20ms period)	P _{G(AV)}	0.5	W
Operating Junction Temperature	T _J	125	°C
Storage Temperature	T _{STG}	-40~150	°C

Notes: Although not recommended, off-state voltages up to 800V may be applied without damage, but the triac may switch to the on-state. The rate of rise of current should not exceed 15A/μs.

■ THERMAL RESISTANCES

PARAMETER	SYMBOL	MIN	TYP	MAX	UNIT
Thermal Resistance, Junction to Ambient In free air	θ _{JA}		60		K/W
Thermal Resistance, Junction to Mounting Base	Full cycle			1.5	K/W
	Half cycle			2.0	

■ STATIC CHARACTERISTICS (T_J=25°C, unless otherwise specified)

PARAMETER	SYMBOL	TEST CONDITIONS	MIN	TYP	MAX	UNIT
Gate Trigger Current	I _{GT}	V _D =12V, I _T =0.1A	T2+ G+	2.5	10	mA
			T2+ G-	4.0	10	
			T2- G-	5.0	10	
			T2- G+	11	25	
Latching Current	I _L	V _D =12V, I _{GT} =0.1A	T2+ G+	3.2	30	mA
			T2+ G-	16	40	
			T2- G-	4.0	30	
			T2- G+	5.5	40	
Holding Current	I _H	V _D =12V, I _{GT} =0.1A		4.0	30	mA
On-State Voltage	V _T	I _T =15A		1.4	1.65	V
Gate Trigger Voltage	V _{GT}	V _D =12V, I _T =0.1A		0.7	1.5	V
		V _D =400V, I _T =0.1A, T _J =125°C	0.25	0.4		V
Off-state Leakage Current	I _D	V _D =V _{DRM(max)} , T _J =125°C		0.1	0.5	mA

■ DYNAMIC CHARACTERISTICS (T_J=25°C, unless otherwise specified)

PARAMETER	SYMBOL	TEST CONDITIONS	MIN	TYP	MAX	UNIT
Critical Rate Of Rise Of Off-State Voltage	dV _D /dt	V _{DM} =67% V _{DRM(max)} , T _J =125°C Exponential waveform, Gate open circuit		50		V/μs
Gate Controlled Turn-on Time	t _{gt}	I _{TM} =16A, V _D =V _{DRM(max)} , I _G =0.1A dI _G /dt=5A/μs		2		μs

■ TYPICAL CHARACTERISTICS

Figure 1. Maximum On-State Dissipation. P_{tot} vs RMS On-state Current, $I_{T(RMS)}$, Where α =Conduction Angle.

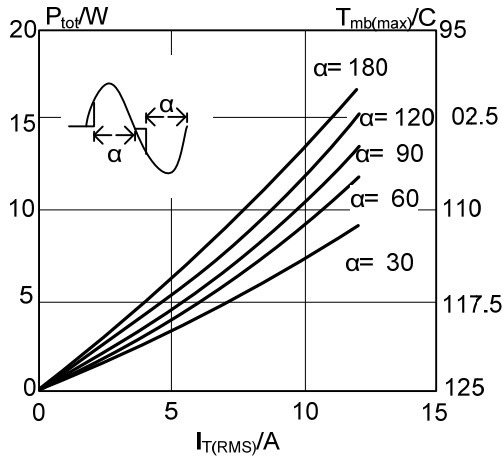

Figure 2. Maximum Permissible Non-Repetitive Peak On-State Current I_{TSM} , vs Pulse Width t_p , for Sinusoidal Currents, $t_p \leq 20ms$.

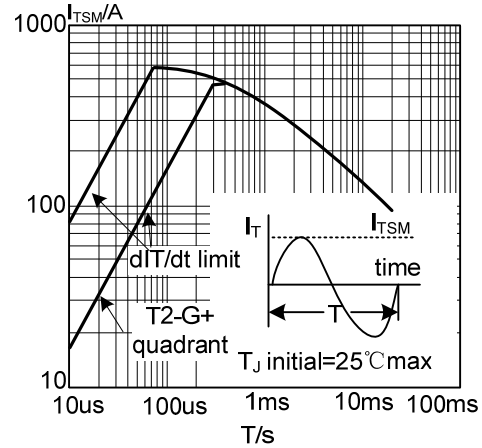

Figure 3. Maximum Permissible Non-Repetitive Peak On-State Current I_{TSM} , vs Number of Cycles, for Sinusoidal Currents, $f=50Hz$.

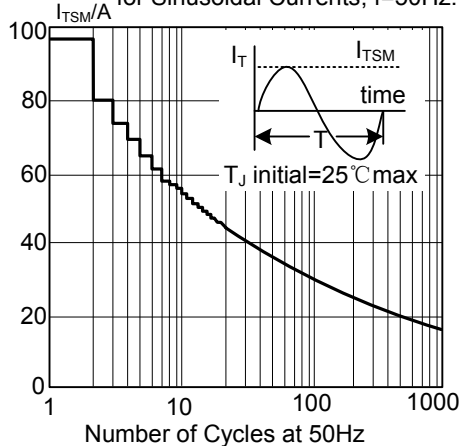

Figure 4. Maximum Permissible RMS Current $I_{T(RMS)}$ vs Mounting Base Temperature T_{mb}

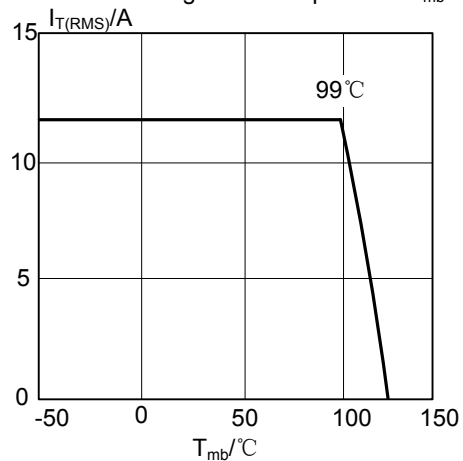

Figure 5. Maximum Permissible Repetitive RMS On-State Current $I_{T(RMS)}$, vs Surge Duration, for Sinusoidal Currents, $f=50Hz$, $T_{mb} \leq 99^\circ C$

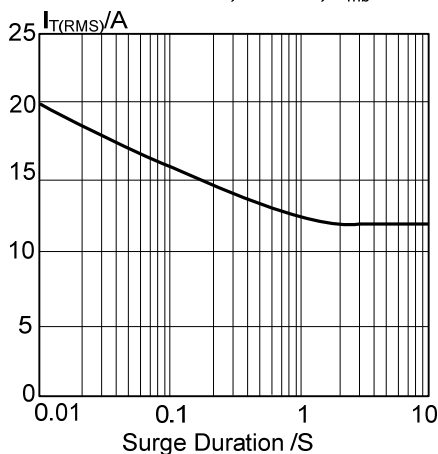
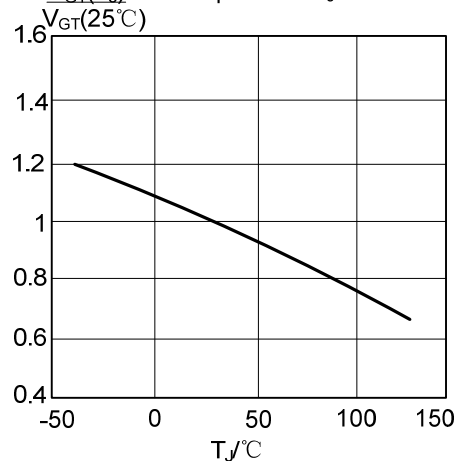

Figure 6. Normalised Gate Trigger Voltage $V_{GT}(T_J)/V_{GT}(25^\circ C)$, vs Junction Temperature T_J



■ TYPICAL CHARACTERISTICS (Cont.)

Figure 7. Normalised Gate Trigger Current $I_{GT}(T_J)/I_{GT}(25^\circ\text{C})$, vs Junction Temperature T_J .

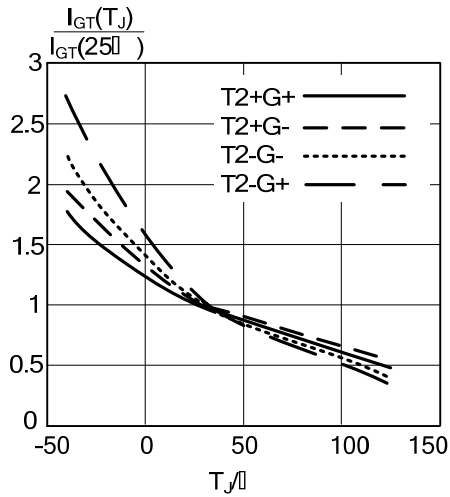

Figure 9. Normalised Holding Current $I_H(T_J)/I_H(25^\circ\text{C})$, vs Junction Temperature T_J .

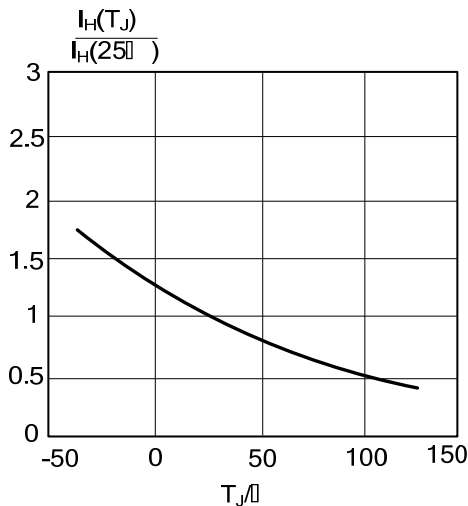

Figure 11. Transient Thermal Impedance $Z_{th\ i-mb}$, vs Pulse Width t_p

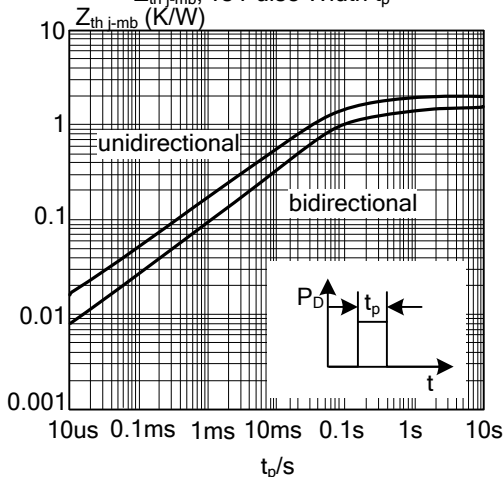

Figure 8. Normalised Latching Current $I_L(T_J)/I_L(25^\circ\text{C})$, vs Junction Temperature T_J .

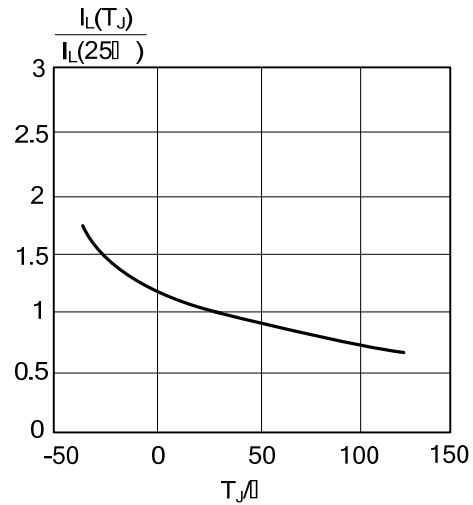

Figure 10. Typical and Maximum On-state Characteristic

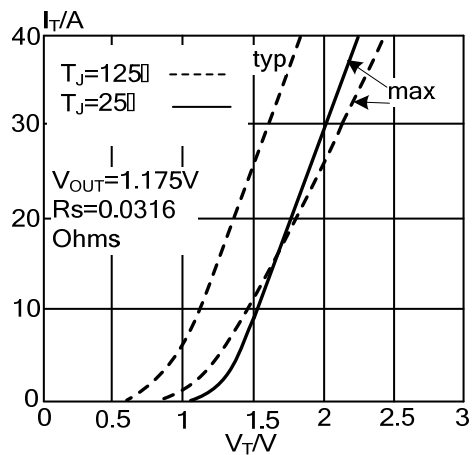
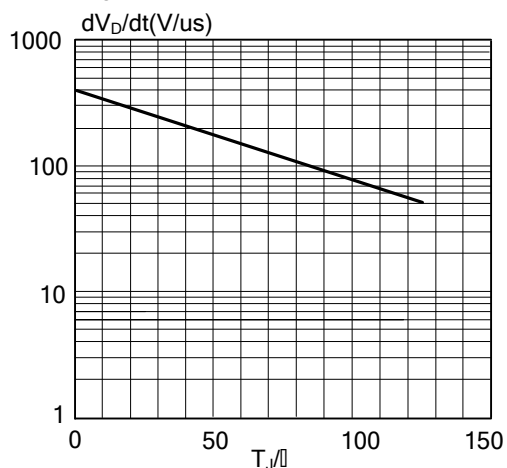

Figure 12. Typical Critical Rate of Rise of Off-State Voltage, dV_D/dt Versus Junction Temperature T_J



UTC assumes no responsibility for equipment failures that result from using products at values that exceed, even momentarily, rated values (such as maximum ratings, operating condition ranges, or other parameters) listed in products specifications of any and all UTC products described or contained herein. UTC products are not designed for use in life support appliances, devices or systems where malfunction of these products can be reasonably expected to result in personal injury. Reproduction in whole or in part is prohibited without the prior written consent of the copyright owner. UTC reserves the right to make changes to information published in this document, including without limitation specifications and product descriptions, at any time and without notice. This document supersedes and replaces all information supplied prior to the publication hereof.