



UT45N03

Power MOSFET

40A, 25V N-CHANNEL POWER MOSFET

FEATURES

- * $R_{DS(ON)} = 21m\Omega @ V_{GS} = 10V$
- * Low capacitance
- * Optimized gate charge
- * Fast switching capability
- * Avalanche energy specified

SYMBOL

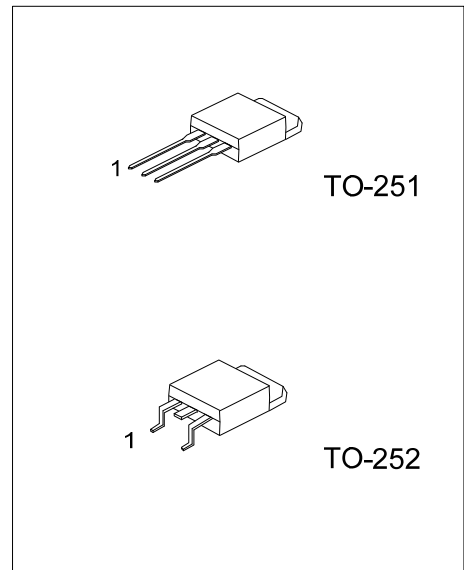
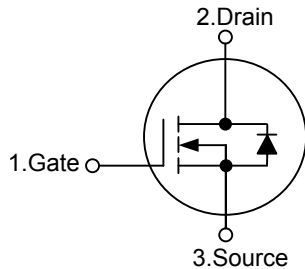

ORDERING INFORMATION

Ordering Number		Package	Pin Assignment			Packing
Lead Free	Halogen Free		1	2	3	
UT45N03L-TM3-R	UT45N03G-TM3-R	TO-251	G	D	S	Tube
UT45N03L-TN3-T	UT45N03G-TN3-T	TO-252	G	D	S	Tube
UT45N03L-TN3-R	UT45N03G-TN3-R	TO-252	G	D	S	Tape Reel

Note: Pin Assignment: G: Gate D: Drain S: Source

	<p>(1) Packing Type</p> <p>(2) Package Type</p> <p>(3) Lead Free</p>	<p>(1) R: Tape Reel, T: Tube</p> <p>(2) TM3: TO-251, TN3: TO-252</p> <p>(3) G: Halogen Free, L: Lead Free</p>
--	--	---



■ ABSOLUTE MAXIMUM RATINGS

PARAMETER	SYMBOL	RATINGS	UNIT
Drain-Source Voltage	V_{DSS}	25	V
Gate-Source Voltage	V_{GSS}	± 15	V
Continuous Drain Current	I_D	40	A
Pulsed Drain Current (Note 1)	I_{DM}	160	A
Power Dissipation	P_D	65	W
Junction Temperature	T_J	+150	$^{\circ}C$
Storage Temperature	T_{STG}	-55 ~ +150	$^{\circ}C$

Note: Absolute maximum ratings are those values beyond which the device could be permanently damaged.

Absolute maximum ratings are stress ratings only and functional device operation is not implied.

■ THERMAL DATA

PARAMETER	SYMBOL	RATINGS	UNIT
Junction to Ambient	θ_{JA}	50	$^{\circ}C/W$
Junction to Case	θ_{JC}	1.92	$^{\circ}C/W$

■ ELECTRICAL CHARACTERISTICS ($T_J = 25^{\circ}C$, unless otherwise specified)

PARAMETER	SYMBOL	TEST CONDITIONS	MIN	TYP	MAX	UNIT
OFF CHARACTERISTICS						
Drain-Source Breakdown Voltage	BV_{DSS}	$V_{GS}=0V, I_D=250\mu A$	25			V
Drain-Source Leakage Current	I_{DSS}	$V_{DS}=25V, V_{GS}=0V$		0.05	10	μA
Drain-Source Breakdown Voltage	I_{GSS}	$V_{DS}=0V, V_{GS}=\pm 5V$		10	100	nA
ON CHARACTERISTICS						
Gate-Threshold Voltage	$V_{GS(TH)}$	$V_{DS}=V_{GS}, I_D=1mA$	1	1.5	2	V
Drain-Source On-State Resistance	$R_{DS(ON)}$	$V_{GS}=5V, I_D=25A$		17.5	24	m Ω
		$V_{GS}=10V, I_D=25A$		13	21	
		$V_{GS}=3.5V, I_D=5.2A$		22	40	
DYNAMIC CHARACTERISTICS						
Input Capacitance	C_{ISS}	$V_{DS}=25V, V_{GS}=0V, f=1MHz$		700		pF
Output Capacitance	C_{OSS}			290		
Reverse Transfer Capacitance	C_{RSS}			200		
SWITCHING PARAMETERS						
Turn-ON Delay Time	$t_{D(ON)}$	$V_{GS}=10V, V_{DD}=15V, I_D=15A, R_G=6\Omega$		10	20	ns
Turn-ON Rise Time	t_R			60	90	
Turn-OFF Delay Time	$t_{D(OFF)}$			35	60	
Turn-OFF Fall-Time	t_F			40	60	
Total Gate Charge	Q_G	$V_{DD}=24V, V_{GS}=5V, I_D=40A$		19		nC
Gate-to-Source Charge	Q_{GS}			5		
Gate-to-Drain Charge	Q_{GD}			8	11	
SOURCE- DRAIN DIODE RATINGS AND CHARACTERISTICS						
Drain-Source Diode Forward Voltage	V_{SD}	$I_S=25A, V_{GS}=0V$		0.95	1.2	V
Maximum Continuous Drain-Source Diode Forward Current	I_S				40	A
Maximum Pulsed Drain-Source Diode Forward Current	I_{SM}				160	

Notes: 1. Pulse width limited by $T_{J(MAX)}$

2. Pulse width $\leq 300\mu s$, duty cycle $\leq 2\%$.

TYPICAL CHARACTERISTICS

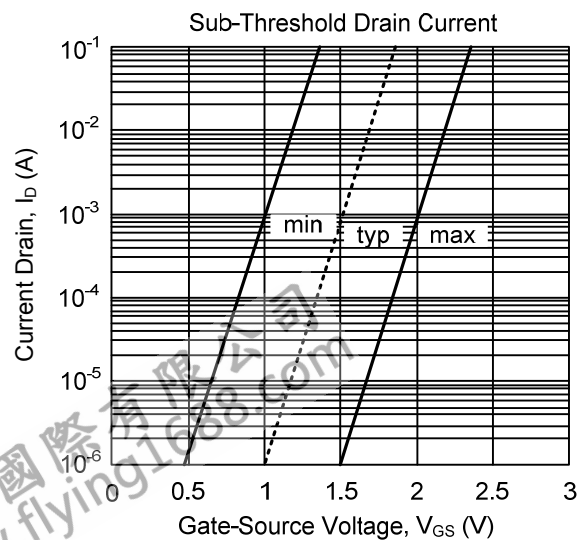
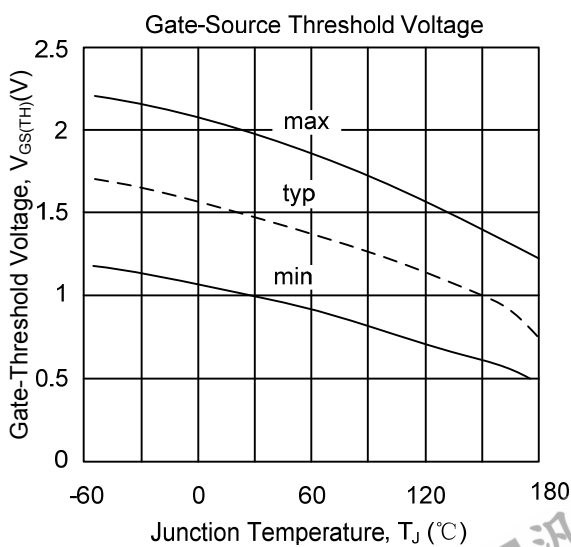
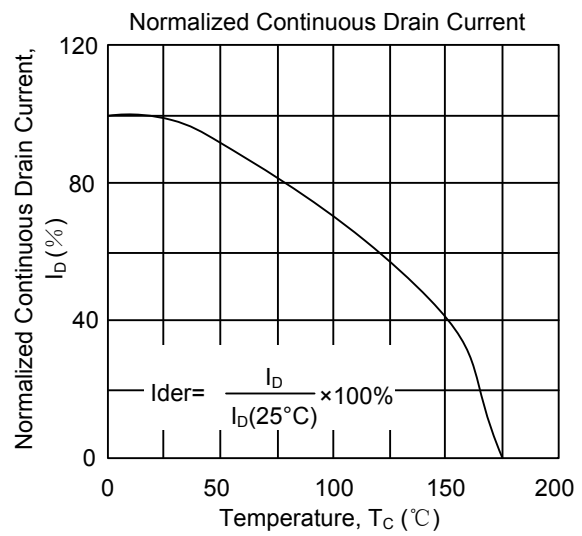
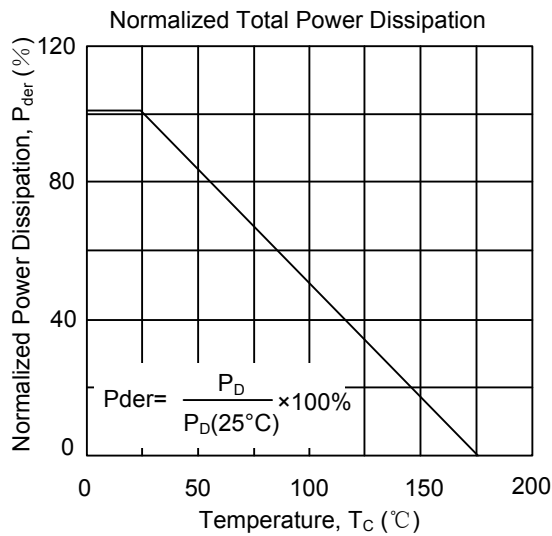
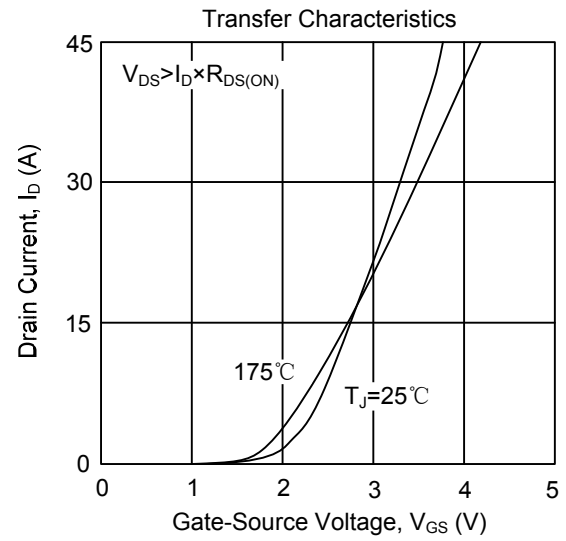
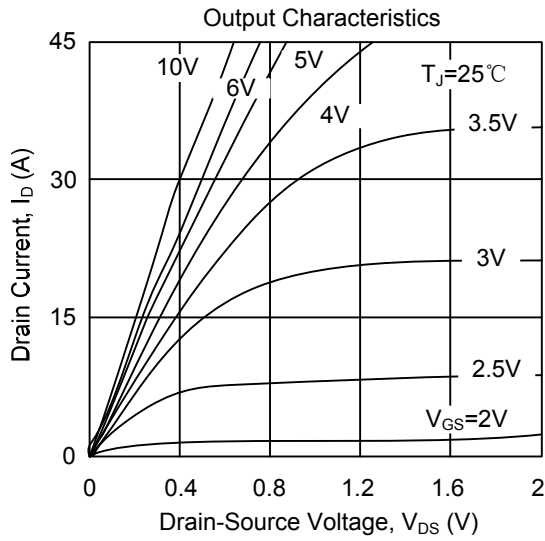

TYPICAL CHARACTERISTICS(Cont.)

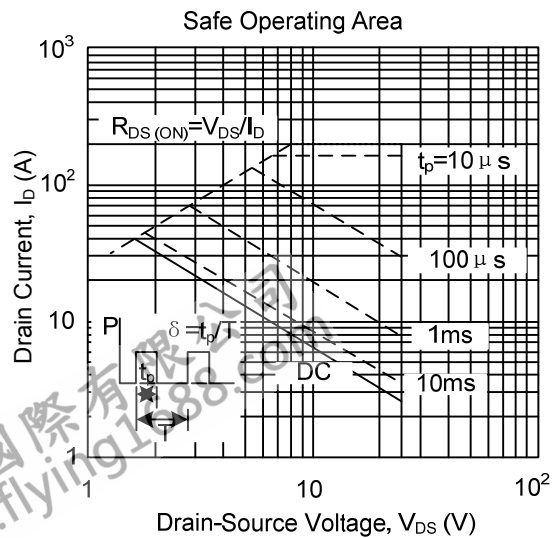
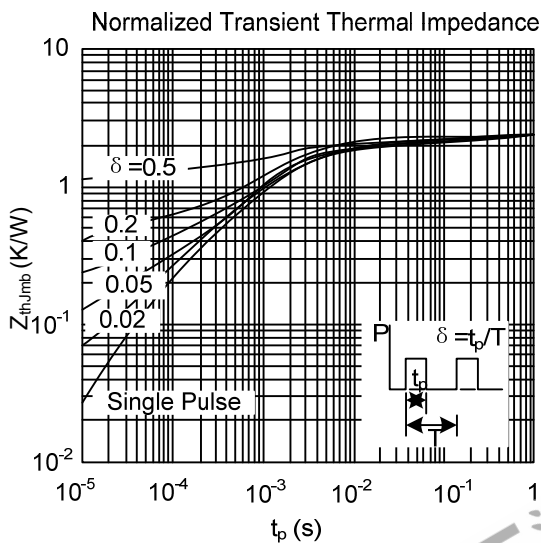
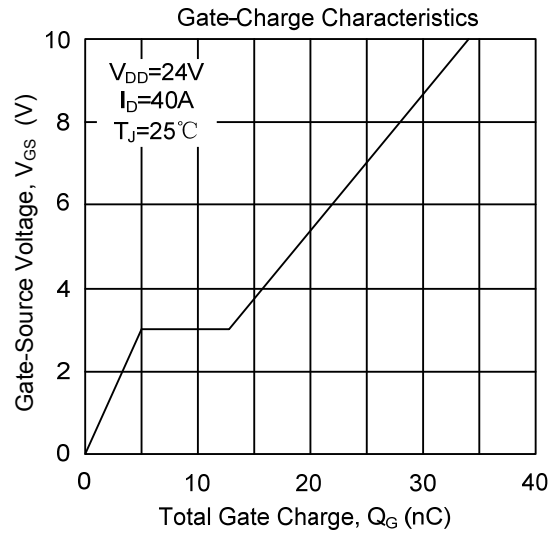
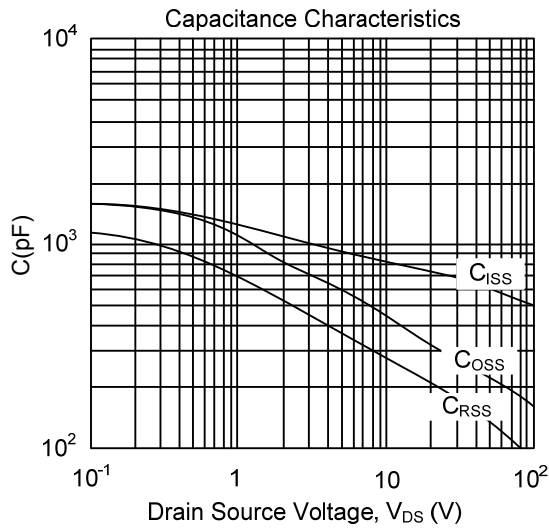
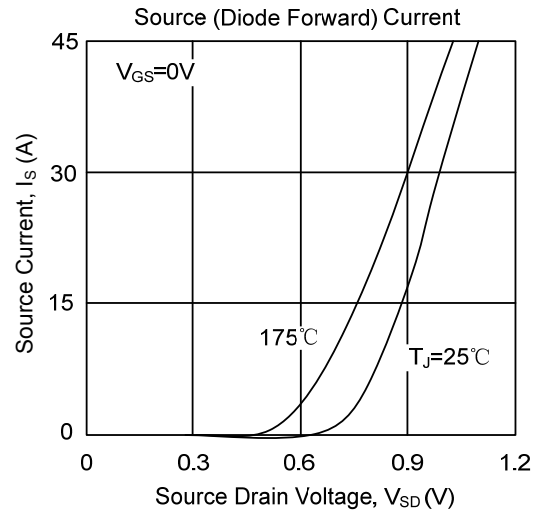
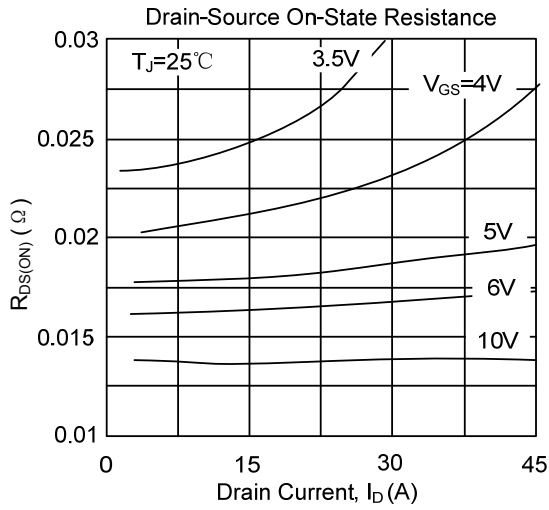

UTC assumes no responsibility for equipment failures that result from using products at values that exceed, even momentarily, rated values (such as maximum ratings, operating condition ranges, or other parameters) listed in products specifications of any and all UTC products described or contained herein. UTC products are not designed for use in life support appliances, devices or systems where malfunction of these products can be reasonably expected to result in personal injury. Reproduction in whole or in part is prohibited without the prior written consent of the copyright owner. The information presented in this document does not form part of any quotation or contract, is believed to be accurate and reliable and may be changed without notice.