



UT50N03

Power MOSFET

50A, 30V N-CHANNEL POWER MOSFET

FEATURES

- * $R_{DS(ON)} < 14\text{ m}\Omega$ @ $V_{GS} = 10\text{ V}$, $I_D = 30\text{ A}$
- * Low capacitance
- * Optimized gate charge
- * Fast switching capability
- * Avalanche energy specified

SYMBOL

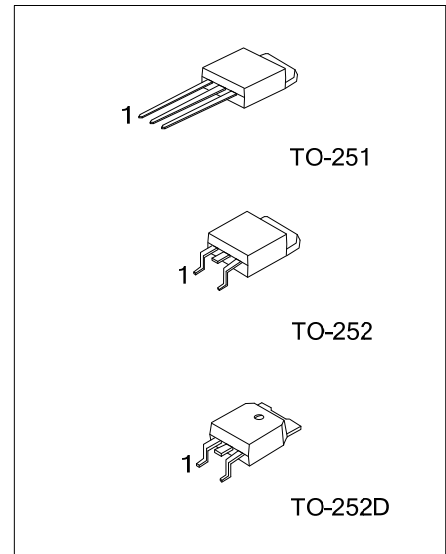
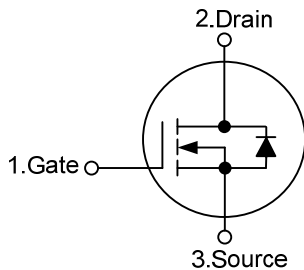

ORDERING INFORMATION

Ordering Number		Package	Pin Assignment			Packing
Lead Free	Halogen Free		1	2	3	
UT50N03L-TM3-T	UT50N03G-TM3-T	TO-251	G	D	S	Tube
UT50N03L-TN3-R	UT50N03G-TN3-R	TO-252	G	D	S	Tape Reel
UT50N03L-TND-R	UT50N03G-TND-R	TO-252D	G	D	S	Tape Reel

Note: Pin Assignment: G: Gate D: Drain S: Source

<p>UT50N03L-TM3-T</p> <p>(1)Packing Type (2)Package Type (3)Green Package</p>	<p>(1) T: Tube, R: Tape Reel (2) TM3: TO-251, TN3: TO-252, TND: TO-252D (3) L: Lead Free, G: Halogen Free and Lead Free</p>
---	---

MARKING

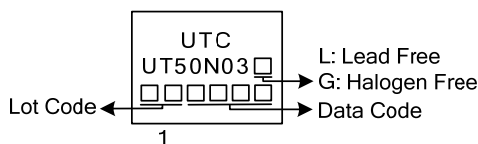

■ ABSOLUTE MAXIMUM RATINGS ($T_J = 25^\circ\text{C}$, unless otherwise specified)

PARAMETER	SYMBOL	RATINGS	UNIT
Drain-Source Voltage	V_{DSS}	30	V
Gate-Source Voltage	V_{GSS}	± 20	V
Continuous Drain Current	I_D	50	A
Pulsed Drain Current (Note 2)	I_{DM}	180	A
Single Pulsed Avalanche Energy (Note 3)	E_{AS}	45	mJ
Power Dissipation	P_D	50	W
Junction Temperature	T_J	+150	$^\circ\text{C}$
Storage Temperature	T_{STG}	-55 ~ +150	$^\circ\text{C}$

Notes: 1. Absolute maximum ratings are those values beyond which the device could be permanently damaged.

Absolute maximum ratings are stress ratings only and functional device operation is not implied.

2. Repetitive Rating: Pulse width limited by maximum junction temperature.

3. $L = 0.1\text{mH}$, $I_{AS} = 30\text{A}$, $V_{DD} = 50\text{V}$, $R_G = 25\ \Omega$, Starting $T_J = 25^\circ\text{C}$.

■ THERMAL DATA

PARAMETER	SYMBOL	RATINGS	UNIT
Junction to Ambient (Note 3)	θ_{JA}	71.4	$^\circ\text{C/W}$
Junction to Case	θ_{JC}	3.0	$^\circ\text{C/W}$

Note: Surface-mounted on FR4 board using 1 sq in pad, 1 oz Cu

■ ELECTRICAL CHARACTERISTICS (T_J = 25°C, unless otherwise specified)

PARAMETER	SYMBOL	TEST CONDITIONS	MIN	TYP	MAX	UNIT
OFF CHARACTERISTICS						
Drain-Source Breakdown Voltage	BV _{DSS}	V _{GS} = 0V, I _D = 250 μA	30			V
Drain-Source Leakage Current	I _{DSS}	V _{DS} = 20V, V _{GS} = 0V			1.5	μA
Gate-Source Leakage Current	I _{GSS}	V _{DS} = 0V, V _{GS} = ±20V			±100	nA
ON CHARACTERISTICS						
Gate-Threshold Voltage	V _{GS(TH)}	V _{DS} = V _{GS} , I _D = 250 μA	1.0	1.7	2.0	V
Drain-Source On-State Resistance	R _{DS(ON)}	V _{GS} = 11.5V	I _D = 30 A	12		mΩ
			I _D = 15 A	11.7		mΩ
		V _{GS} = 10 V	I _D = 30 A	12.5	14	mΩ
			I _D = 15 A	19	23	mΩ
DYNAMIC PARAMETERS						
Input Capacitance	C _{ISS}	V _{DS} = 12V, V _{GS} = 0V, f = 1MHz		610	750	pF
Output Capacitance	C _{OSS}			300		pF
Reverse Transfer Capacitance	C _{RSS}			125		pF
SWITCHING PARAMETERS						
Turn-ON Delay Time	t _{D(ON)}	V _{GS} = 4.5 V, V _{DS} = 15 V, I _D = 30 A, R _G = 3.0Ω		8.2		ns
Turn-ON Rise Time	t _R			9.6		ns
Turn-OFF Delay Time	t _{D(OFF)}			11.2		ns
Turn-OFF Fall-Time	t _F			6.8		ns
Turn-ON Delay Time	t _{D(ON)}	V _{GS} = 11.5 V, V _{DS} = 15 V, I _D = 30 A, R _G = 3.0Ω		5.0		ns
Turn-ON Rise Time	t _R			84		ns
Turn-OFF Delay Time	t _{D(OFF)}			15		ns
Turn-OFF Fall-Time	t _F			4.0		ns
Total Gate Charge	Q _G	V _{DS} = 15V, V _{GS} = 4.5V, I _D = 30 A		6.0	10	nC
Gate-to-Source Charge	Q _{GS}			1.9		nC
Gate-to-Drain Charge	Q _{GD}			3.7		nC
Total Gate Charge	Q _G	V _{DS} = 15V, V _{GS} = 11.5V, I _D = 30 A		15		nC
Gate-to-Source Charge	Q _{GS}			1.9		nC
Gate-to-Drain Charge	Q _{GD}			3.9		nC
SOURCE- DRAIN DIODE RATINGS AND CHARACTERISTICS						
Drain-Source Diode Forward Voltage	V _{SD}	I _S = 30 A, V _{GS} = 0V		0.85	1.1	V
Maximum Continuous Drain-Source Diode Forward Current	I _S				45	A
Reverse Recovery Time	t _{rr}	I _S = 30 A, V _{GS} = 0 V,		24		ns
Reverse Recovery Charge	Q _{RR}	di / dt = 100 A/μs		14		nC

Notes: 1. Pulse width limited by T_{J(MAX)}

2. Pulse Test: Pulse Width ≤ 300 μs, Duty Cycles ≤ 2%

TYPICAL CHARACTERISTICS

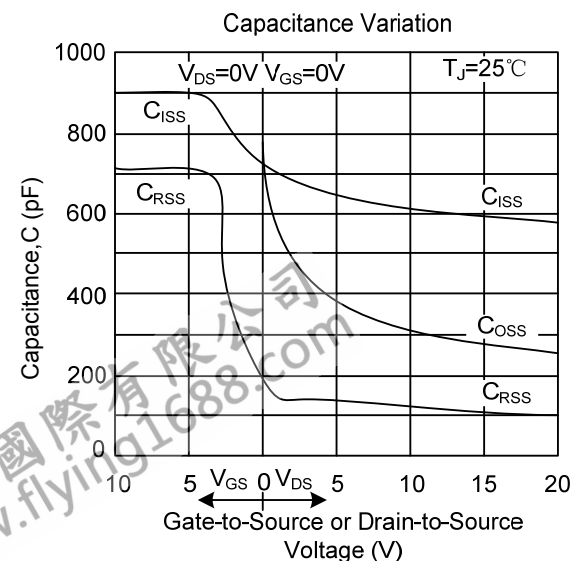
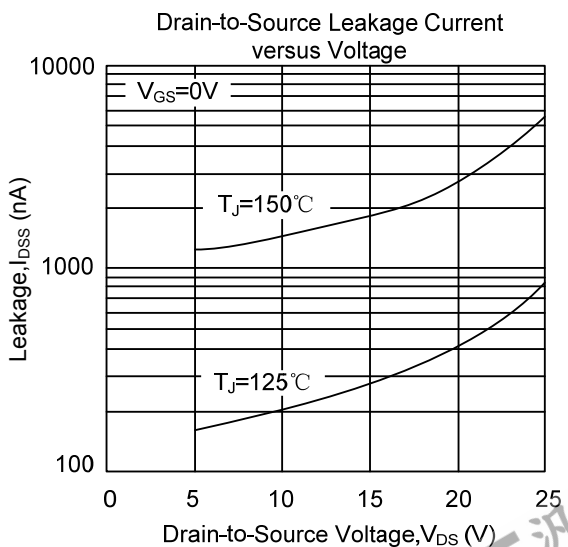
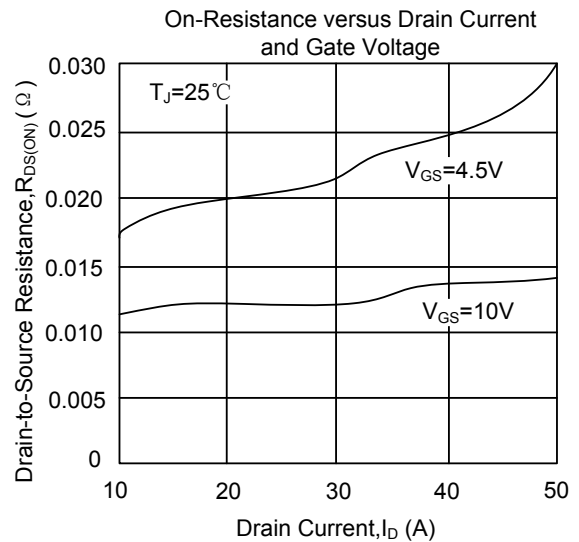
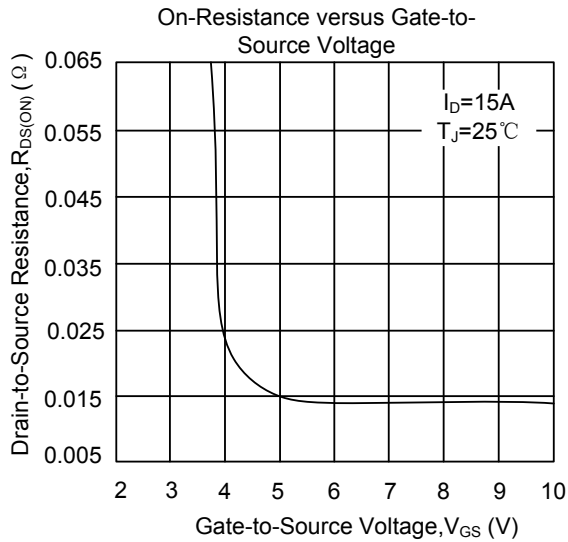
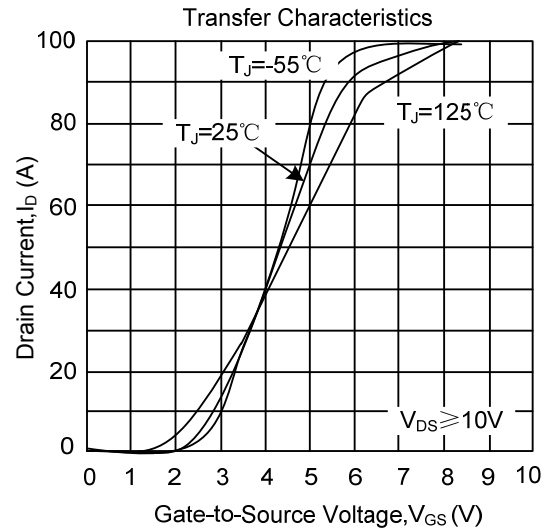
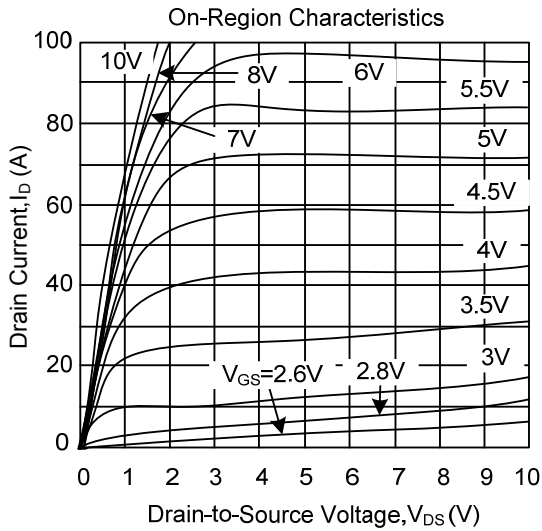

■ TYPICAL CHARACTERISTICS(Cont.)

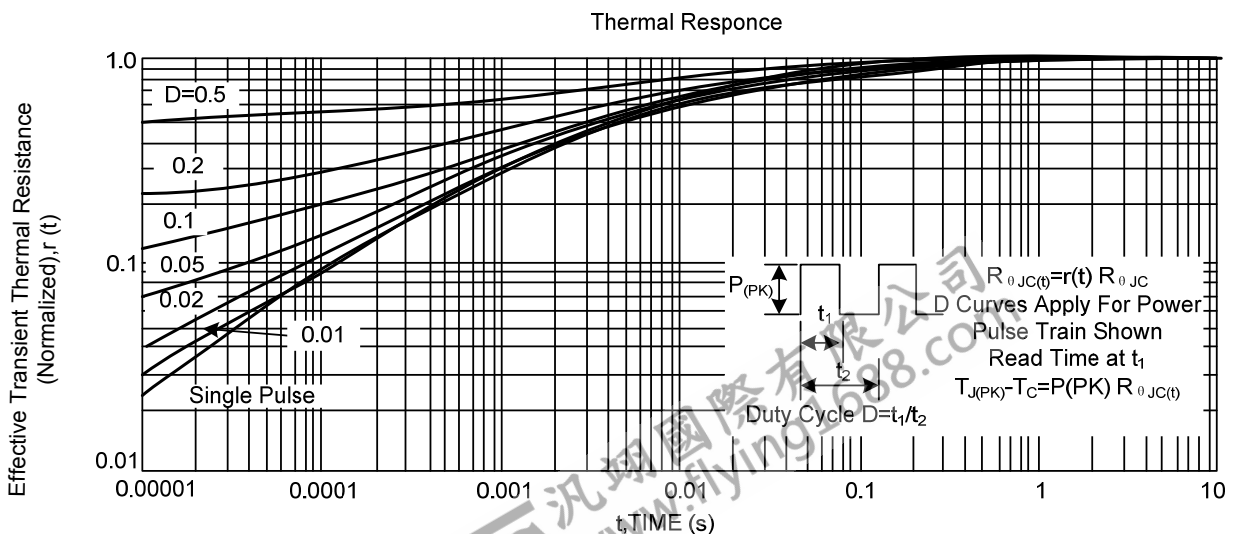
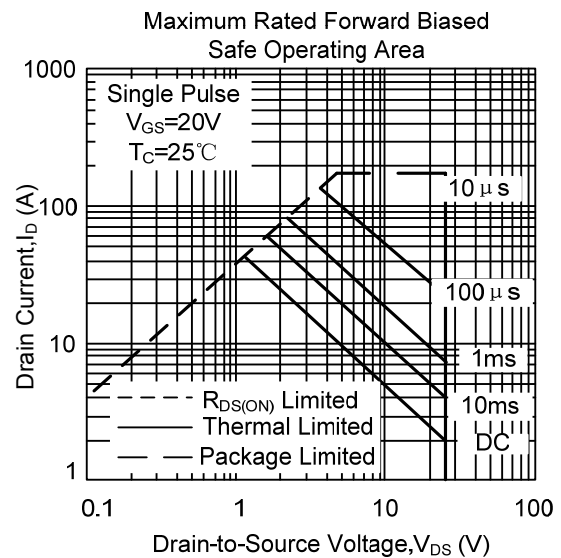
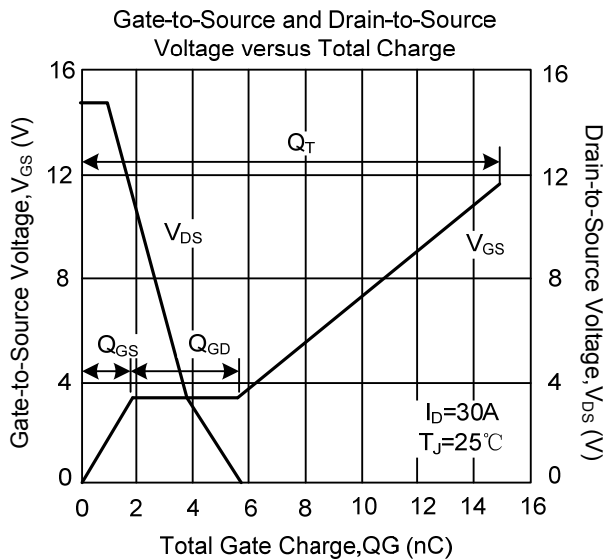
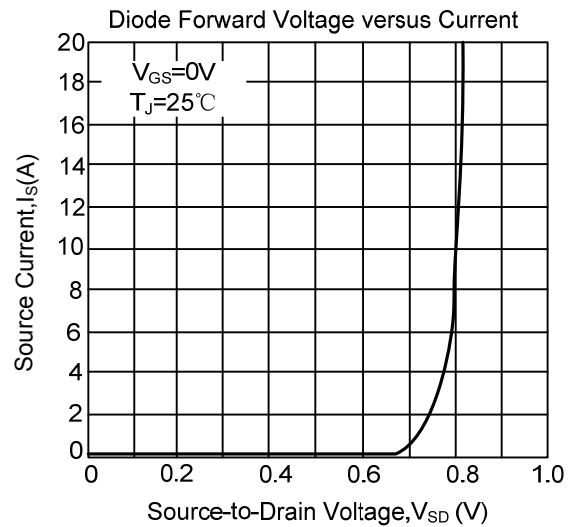
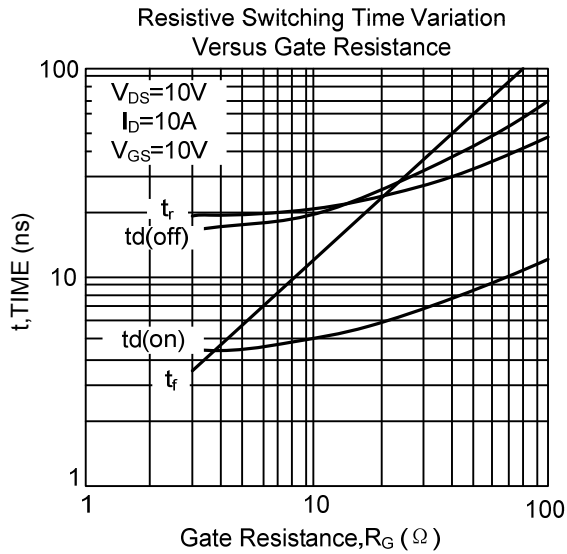

UTC assumes no responsibility for equipment failures that result from using products at values that exceed, even momentarily, rated values (such as maximum ratings, operating condition ranges, or other parameters) listed in products specifications of any and all UTC products described or contained herein. UTC products are not designed for use in life support appliances, devices or systems where malfunction of these products can be reasonably expected to result in personal injury. Reproduction in whole or in part is prohibited without the prior written consent of the copyright owner. The information presented in this document does not form part of any quotation or contract, is believed to be accurate and reliable and may be changed without notice.