



UTD351

Power MOSFET

N-CHANNEL ENHANCEMENT MODE

DESCRIPTION

As N-Channel Logic Level MOSFET, **UTD351** has been optimized for battery power management applications. And it's produced using UTC's Trench process.

SYMBOL

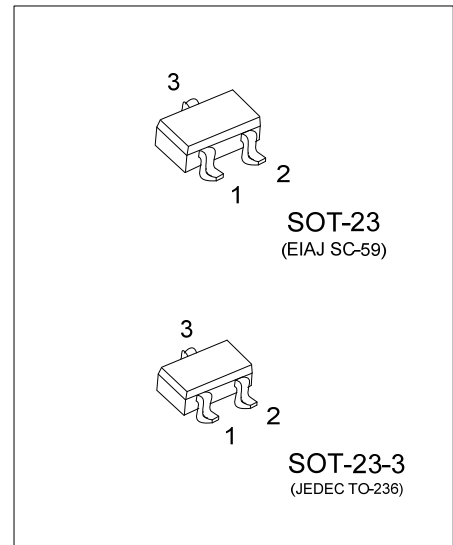
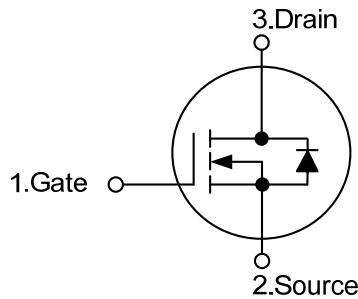

ORDERING INFORMATION

Order Number		Package	Pin Assignment			Packing
Lead Free	Halogen Free		1	2	3	
UTD351L-AE2-R	UTD351G-AE2-R	SOT-23-3	G	S	D	Tape Reel
UTD351L-AE3-R	UTD351G-AE3-R	SOT-23	G	S	D	Tape Reel

Note: Pin Assignment: G: Gate S: Source D: Drain

<p>UTD351G-AE2-R</p> <p>(1)Packing Type (2)Package Type (3)Green Package</p>	<p>(1) R: Tape Reel (2) AE2: SOT-23-3, AE3: SOT-23 (3) G: Halogen Free and Lead Free , L: Lead Free</p>
--	---

MARKING

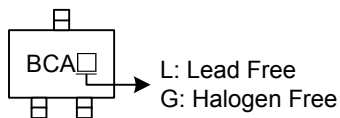

■ ABSOLUTE MAXIMUM RATINGS ($T_A = 25^\circ\text{C}$, unless otherwise specified)

PARAMETER	SYMBOL	RATINGS	UNIT
Drain-Source Voltage	V_{DSS}	30	V
Gate-Source Voltage	V_{GSS}	± 20	
Continuous Drain Current (Note 3)	I_D	1.4	A
Pulsed Drain Current	I_{DM}	10	
Power Dissipation	P_D	0.5	W
Junction Temperature	T_J	+150	$^\circ\text{C}$
Storage Temperature	T_{STG}	-55 ~ +150	$^\circ\text{C}$

Note: Absolute maximum ratings are those values beyond which the device could be permanently damaged.

Absolute maximum ratings are stress ratings only and functional device operation is not implied.

■ THERMAL CHARACTERISTICS

PARAMETER	SYMBOL	MIN	TYP	MAX	UNIT
Junction-to-Ambient (Note 3)	θ_{JA}		250		$^\circ\text{C/W}$
Junction-to-Case	θ_{JC}		75		$^\circ\text{C/W}$

■ ELECTRICAL CHARACTERISTICS ($T_A = 25^\circ\text{C}$, unless otherwise specified)

PARAMETER	SYMBOL	TEST CONDITIONS	MIN	TYP	MAX	UNIT
OFF CHARACTERISTICS						
Drain-Source Breakdown Voltage	BV_{DSS}	$V_{GS} = 0\text{ V}, I_D = 250\ \mu\text{A}$	30			V
Drain-Source Leakage Current	I_{DSS}	$V_{DS} = 24\text{ V}, V_{GS} = 0\text{ V}$			1	μA
Gate-Source Leakage Current	I_{GSS}	$V_{GS} = \pm 20\text{ V}, V_{DS} = 0\text{ V}$			± 100	nA
Breakdown Voltage Temperature Coefficient	$\Delta BV_{DSS}/\Delta T_J$	$I_D = 250\ \mu\text{A}$, Referenced to 25°C		26		$\text{mV}/^\circ\text{C}$
ON CHARACTERISTICS (Note2)						
Gate-Threshold Voltage	$V_{GS(TH)}$	$V_{DS} = V_{GS}, I_D = 250\ \mu\text{A}$	0.8	2.1	3	V
Static Drain-Source On-Resistance	$R_{DS(ON)}$	$V_{GS} = 10\text{ V}, I_D = 1.4\text{ A}$		92	160	m Ω
		$V_{GS} = 4.5\text{ V}, I_D = 1.2\text{ A}$		120	250	
DYNAMIC PARAMETERS						
Input Capacitance	C_{ISS}	$V_{DS} = 15\text{ V}, V_{GS} = 0\text{ V}, f = 1.0\text{ MHz}$		145		pF
Output Capacitance	C_{OSS}			35		
Reverse Transfer Capacitance	C_{RSS}			15		
SWITCHING PARAMETERS (Note2)						
Total Gate Charge	Q_G	$V_{DS} = 15\text{ V}, V_{GS} = 4.5\text{ V}, I_D = 1.4\text{ A}$		1.3	1.8	nC
Gate-Source Charge	Q_{GS}			0.5		
Gate-Drain Charge	Q_{GD}			0.5		
Turn-ON Delay Time	$t_{D(ON)}$	$V_{DD} = 15\text{ V}, I_D = 1\text{ A}, V_{GS} = 10\text{ V}, R_{GEN} = 6\ \Omega$		3	6	ns
Turn-ON Rise Time	t_R			8	16	
Turn-OFF Delay Time	$t_{D(OFF)}$			16	29	
Turn-OFF Fall-Time	t_F			2	4	
SOURCE- DRAIN DIODE RATINGS AND CHARACTERISTICS						
Maximum Continuous Drain-Source Diode Forward Current	I_S				0.42	A
Drain-Source Diode Forward Voltage	V_{SD}	$V_{GS} = 0\text{ V}, I_S = 0.42\text{ A}$ (Note 2)		0.8	1.2	V
Reverse Recovery Time	t_{rr}	$I_F = 1.4\text{ A}, dI_F/dt = 100\text{ A}/\mu\text{s}$		11		ns
Reverse Recovery Charge	Q_{rr}			4		nC

Notes: 1. Repetitive Rating: Pulse width limited by maximum junction temperature.

2. Pulse width $\leq 300\ \mu\text{s}$, duty cycle $\leq 2\%$.

3. Surface mounted on 1 in^2 copper pad of FR4 board; $250\ ^\circ\text{C/W}$ when mounted on min.

■ TYPICAL CHARACTERISTICS

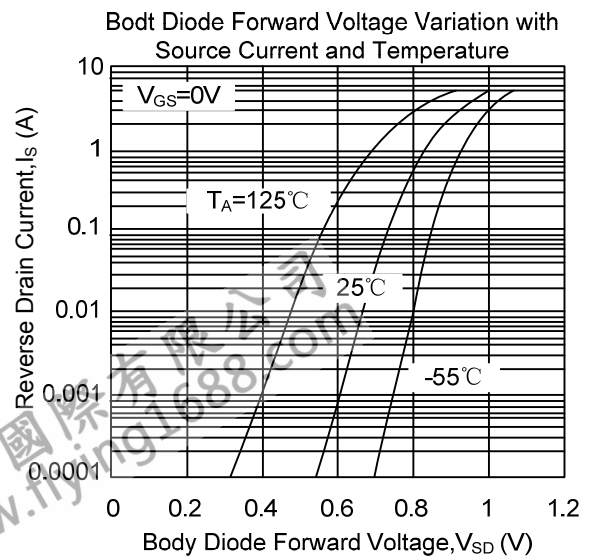
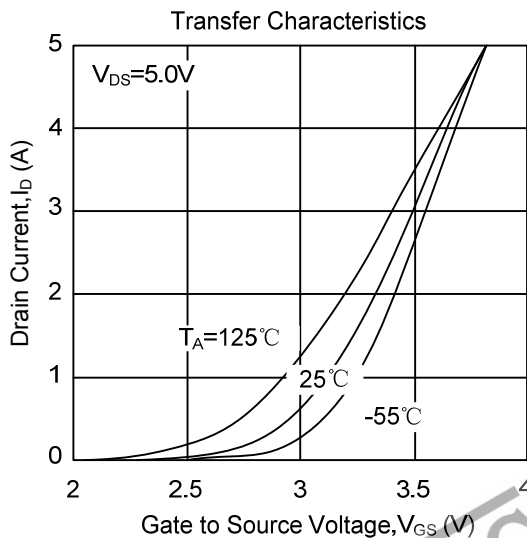
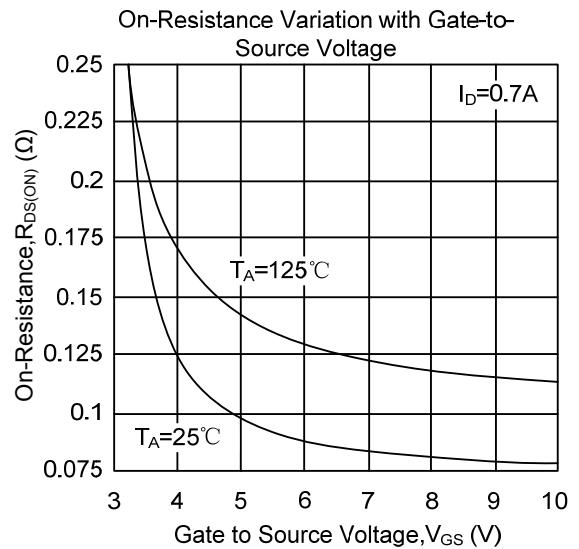
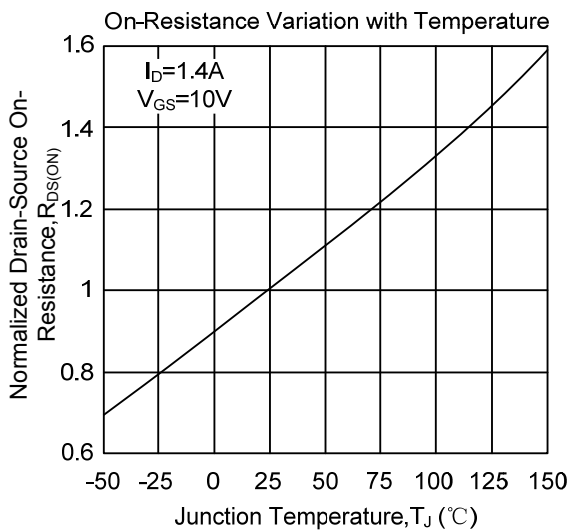
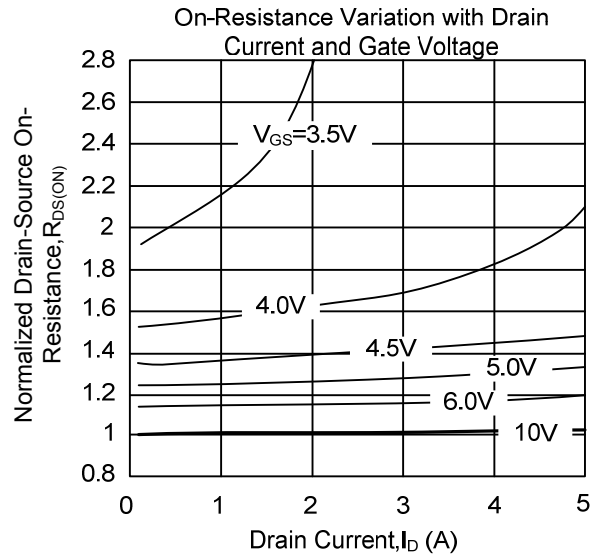
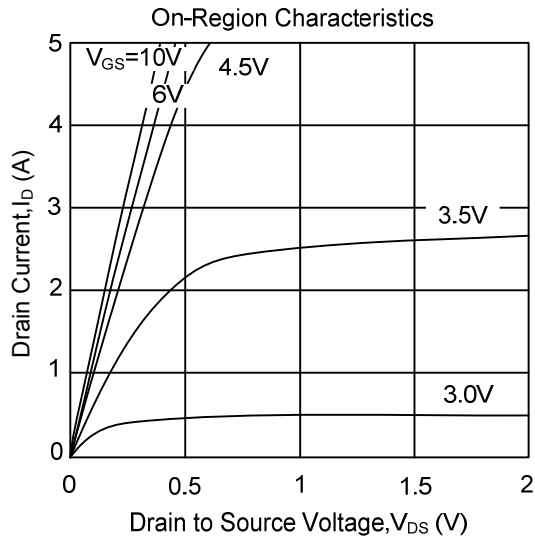

■ TYPICAL CHARACTERISTICS (Cont.)

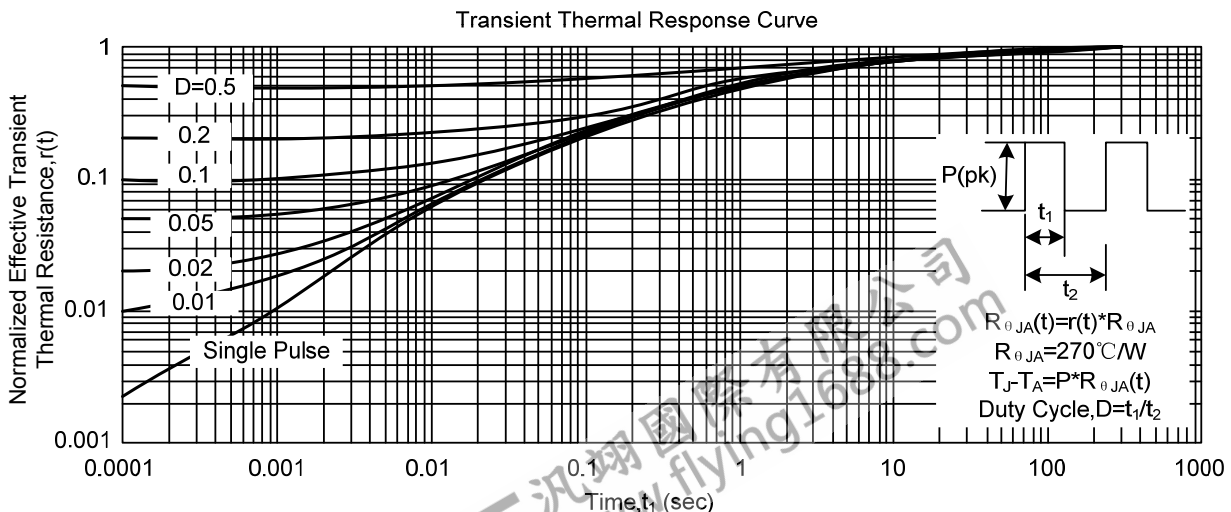
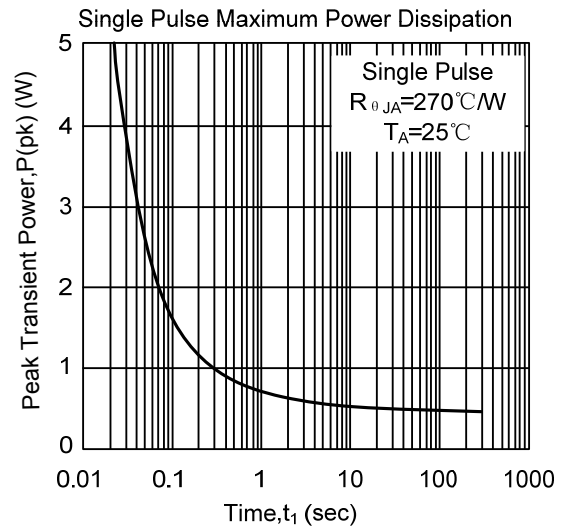
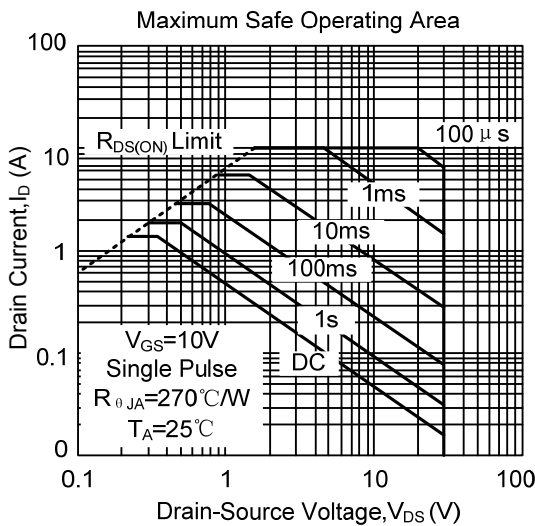
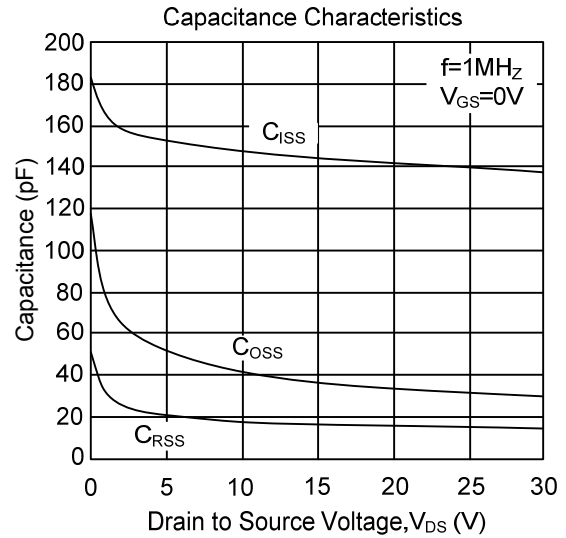
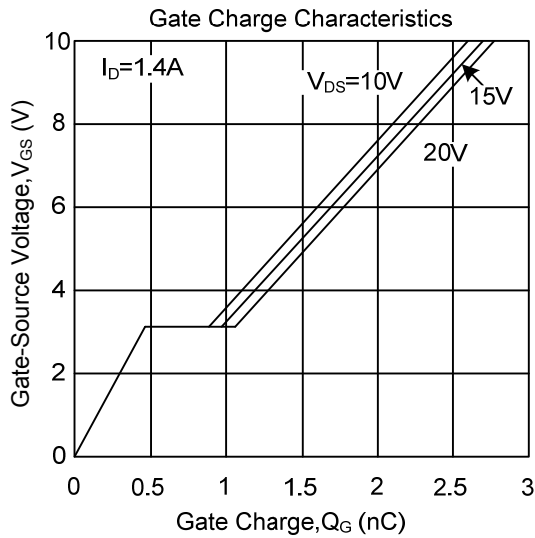

UTC assumes no responsibility for equipment failures that result from using products at values that exceed, even momentarily, rated values (such as maximum ratings, operating condition ranges, or other parameters) listed in products specifications of any and all UTC products described or contained herein. UTC products are not designed for use in life support appliances, devices or systems where malfunction of these products can be reasonably expected to result in personal injury. Reproduction in whole or in part is prohibited without the prior written consent of the copyright owner. UTC reserves the right to make changes to information published in this document, including without limitation specifications and product descriptions, at any time and without notice. This document supersedes and replaces all information supplied prior to the publication hereof.