



UTD410

Power MOSFET

N-CHANNEL ENHANCEMENT MODE

DESCRIPTION

The **UTD410** can provide excellent $R_{DS(ON)}$ and low gate charge by using advanced trench technology. This **UTD410** is suitable for using as a load switch or in PWM applications.

FEATURES

* $V_{DS}=30V, I_D=8A$

* $R_{DS(ON)}=48m\Omega @V_{GS}=10V$

SYMBOL

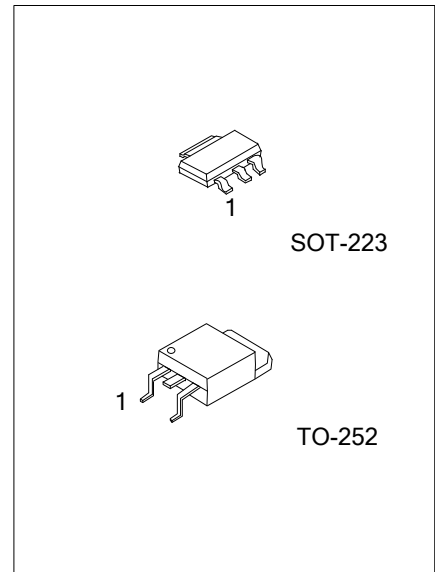
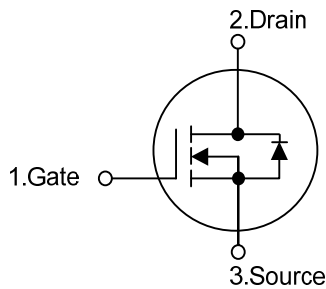

ORDERING INFORMATION

Ordering Number		Package	Pin Assignment			Packing
Lead Free	Halogen Free		1	2	3	
UTD410L-TN3-R	UTD410G-TN3-R	TO-252	G	D	S	Tape Reel
UTD410L-TN3-T	UTD410G-TN3-T	TO-252	G	D	S	Tube
UTD410L-AA3-R	UTD410G-AA3-R	SOT-223	G	D	S	Tape Reel

<p>UTD410L-TN3-R</p> <p>(1)Packing Type</p> <p>(2)Package Type</p> <p>(3)Lead Plating</p>	<p>(1) R: Tape Reel, T: Tube</p> <p>(2) TN3: TO-252, AA3: SOT-223</p> <p>(3) L: Lead Free, G: Halogen Free</p>
---	--

■ ABSOLUTE MAXIMUM RATINGS (T_A=25°C, unless otherwise specified)

PARAMETER	SYMBOL	RATINGS	UNIT
Drain-Source Voltage	V _{DSS}	30	V
Gate-Source Voltage	V _{GSS}	±20	
Continuous Drain Current	I _D	8	A
Pulsed Drain Current (Note1)	I _{DM}	20	
Repetitive Avalanche Energy (L=0.1mH Note1)	E _{AR}	10	mJ
Power Dissipation (T _C =25°C)	TO-252	P _D	2
	SOT-223		2.3
Junction Temperature	T _J	+175	°C
Storage Temperature	T _{STG}	-55 ~ +175	°C

Note: Absolute maximum ratings are those values beyond which the device could be permanently damaged.

Absolute maximum ratings are stress ratings only and functional device operation is not implied.

■ THERMAL DATA

PARAMETER	SYMBOL	MIN	TYP	MAX	UNIT
Junction-to-Ambient (T _C =25°C)	TO-252	θ _{JA}	46	60	°C/W
	SOT-223			55	°C/W

■ ELECTRICAL CHARACTERISTICS (T_J=25°C, unless otherwise specified)

PARAMETER	SYMBOL	TEST CONDITIONS	MIN	TYP	MAX	UNIT
OFF CHARACTERISTICS						
Drain-Source Breakdown Voltage	BV _{DSS}	V _{GS} =0 V, I _D =250μA	30			V
Drain-Source Leakage Current	I _{DSS}	V _{DS} =24V, V _{GS} =0V			1	μA
Gate-Source Leakage Current	I _{GSS}	V _{DS} =0 V, V _{GS} =±20V			±100	nA
ON CHARACTERISTICS						
Gate-Threshold Voltage	V _{GS(TH)}	V _{DS} =V _{GS} , I _D =250μA	1	1.8	3	V
Drain-Source On-State Resistance	R _{DS(ON)}	V _{GS} =10V, I _D =8A		48	65	mΩ
		V _{GS} =4.5V, I _D =2A		75	105	
DYNAMIC CHARACTERISTICS						
Input Capacitance	C _{ISS}	V _{DS} =15 V, V _{GS} =0V, f=1MHz		288		pF
Output Capacitance	C _{OSS}			57		pF
Reverse Transfer Capacitance	C _{RSS}			39		pF
SWITCHING CHARACTERISTICS						
Turn-On Delay Time	t _{D(ON)}	V _{GS} =10V, V _{DD} =15V, R _L =1.8Ω, R _G =3Ω		3.7		ns
Turn-On Rise Time	t _R			3.7		ns
Turn-Off Delay Time	t _{D(OFF)}			15.6		ns
Turn-Off Fall-Time	t _F			2.6		ns
Total Gate Charge	Q _G			6.72		nC
Gate-Source Charge	Q _{GS}	V _{GS} =10V, V _{DS} =15V, I _D =8A		0.76		nC
Gate-Drain Charge	Q _{GD}			1.78		nC
SOURCE- DRAIN DIODE RATINGS AND CHARACTERISTICS						
Drain-Source Diode Forward Voltage	V _{SD}	V _{GS} =0V, I _S =1A		0.75	1	V
Maximum Continuous Drain-Source Diode Forward Current	I _S				4.3	A
Reverse Recovery Time	t _{RR}	I _F =8A, dI _F /dt=100A/μs		12.6		ns
Reverse Recovery Charge	Q _{RR}			5.1		nC

Note: 1. Pulse width limited by T_{J(MAX)}

2. Pulse width ≤300us, duty cycle ≤2%.

3. Surface mounted on 1 in² copper pad of FR4 board.

TYPICAL CHARACTERISTICS

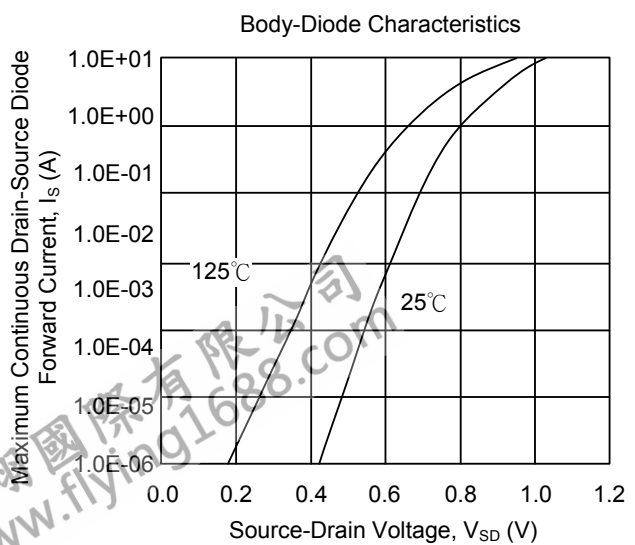
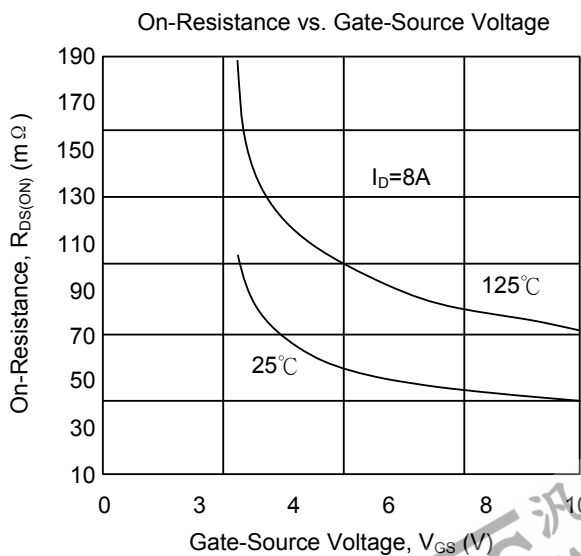
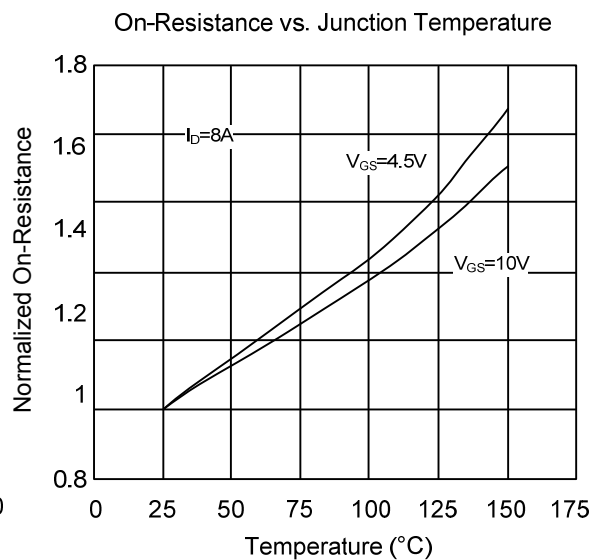
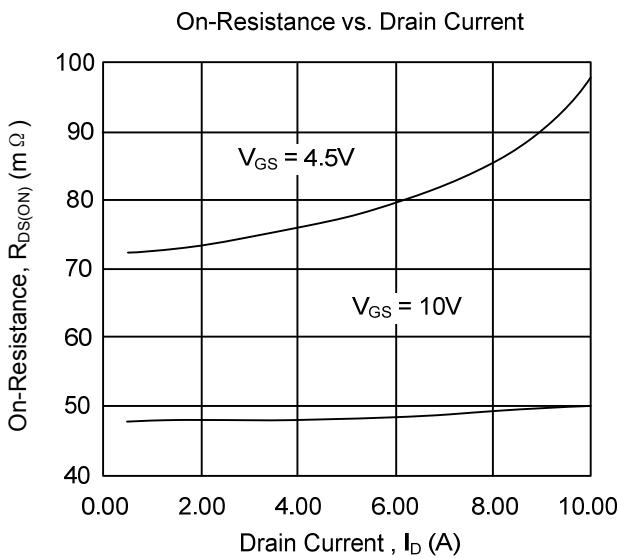
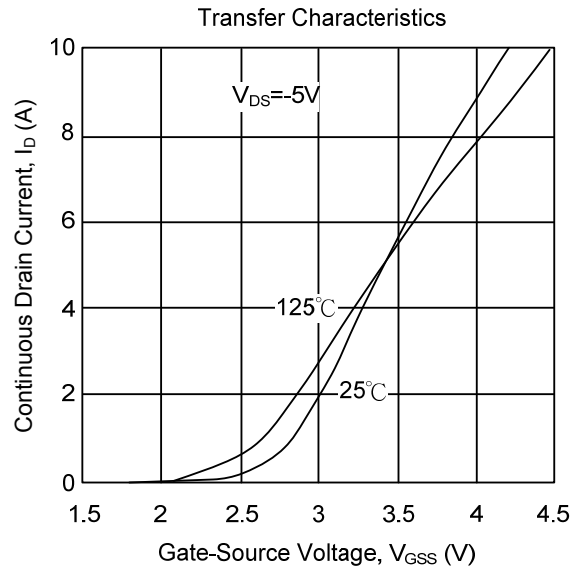
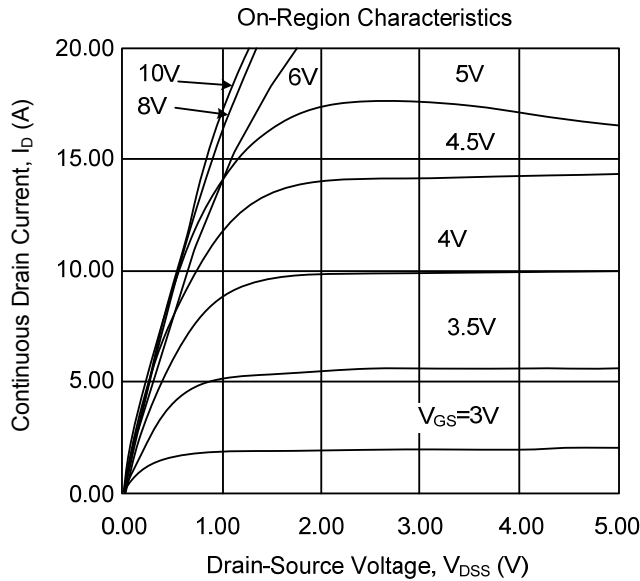

TYPICAL CHARACTERISTICS(Cont.)

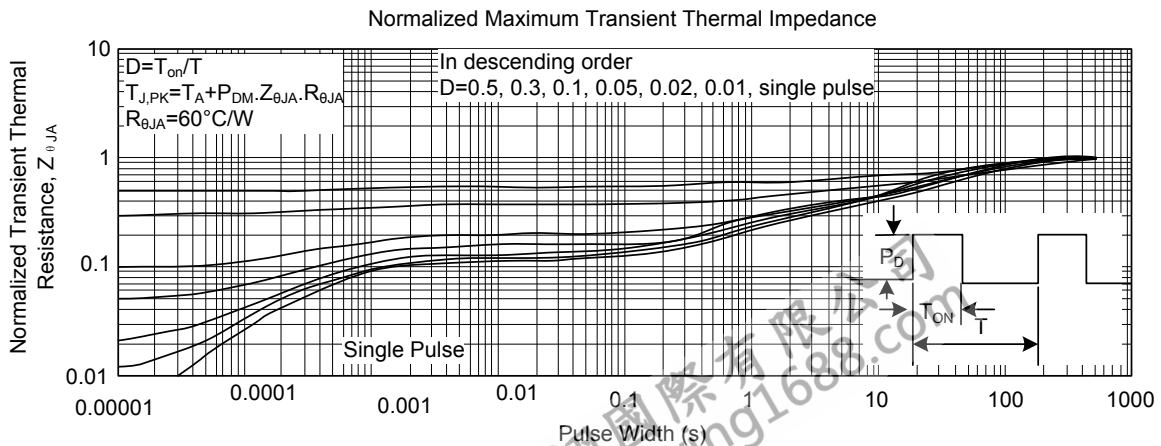
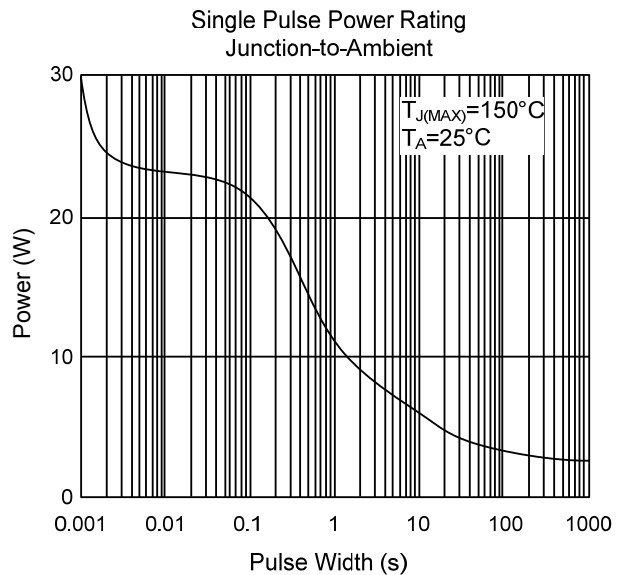
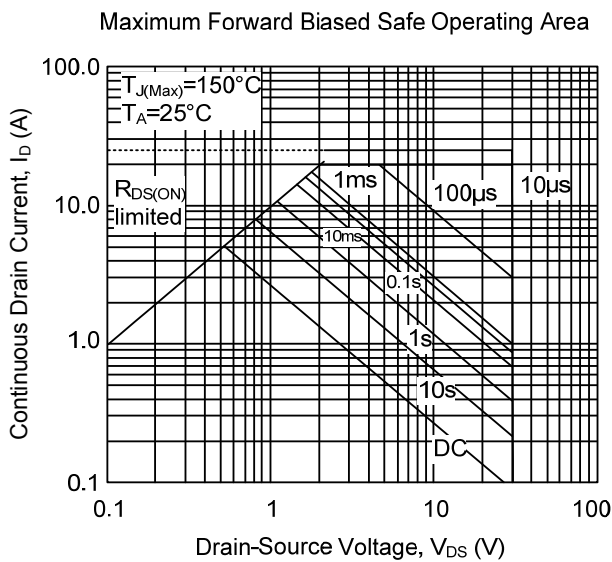
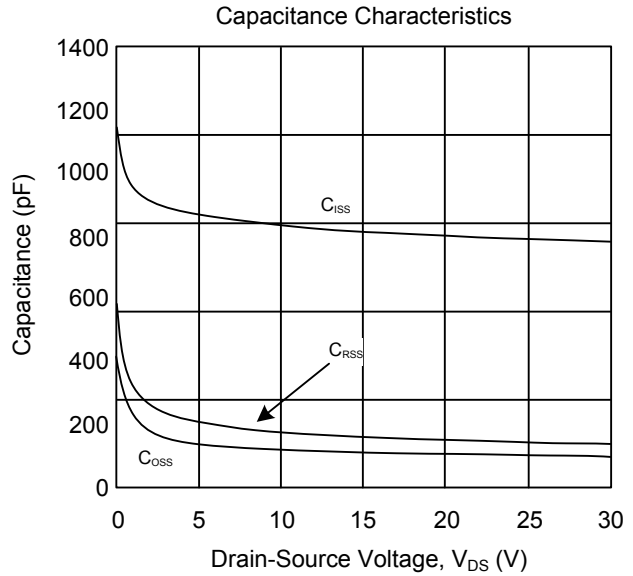
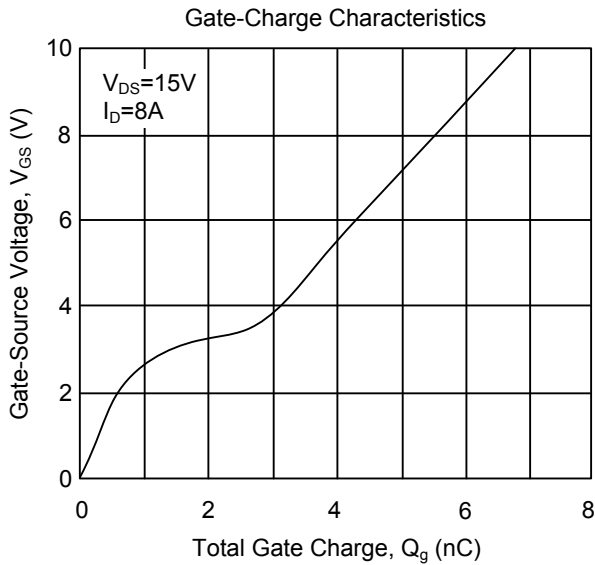

UTC assumes no responsibility for equipment failures that result from using products at values that exceed, even momentarily, rated values (such as maximum ratings, operating condition ranges, or other parameters) listed in products specifications of any and all UTC products described or contained herein. UTC products are not designed for use in life support appliances, devices or systems where malfunction of these products can be reasonably expected to result in personal injury. Reproduction in whole or in part is prohibited without the prior written consent of the copyright owner. The information presented in this document does not form part of any quotation or contract, is believed to be accurate and reliable and may be changed without notice.