



## UTD413

Power MOSFET

### P-CHANNEL ENHANCEMENT MODE

#### DESCRIPTION

The **UTD413** can provide excellent  $R_{DS(ON)}$  and low gate charge by using UTC's advanced trench technology. The **UTD413** is well suited for high current load applications with the excellent thermal resistance of the TO-252 package. Standard Product **UTD413** is Pb-free.

#### FEATURES

- \*  $R_{DS(ON)} < 45\text{ m}\Omega$  @  $V_{GS} = -10\text{V}$ ,  $I_D = -12\text{A}$
- \*  $R_{DS(ON)} < 69\text{ m}\Omega$  @  $V_{GS} = -4.5\text{V}$ ,  $I_D = -8\text{A}$
- \* Low capacitance
- \* Low gate charge
- \* Fast switching capability
- \* Avalanche energy specified

#### SYMBOL

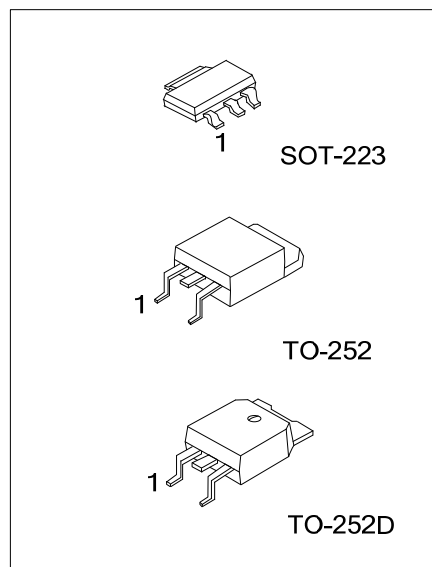
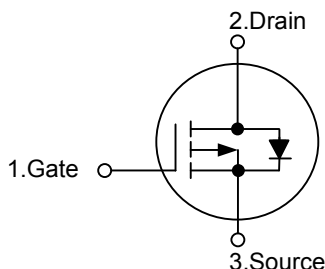

#### ORDERING INFORMATION

Ordering Number		Package	Pin Assignment			Packing
Lead Free	Halogen Free		1	2	3	
-	UTD413G-AA3-R	SOT-223	G	D	S	Tape Reel
UTD413L-TN3-R	UTD413G-TN3-R	TO-252	G	D	S	Tape Reel
UTD413L-TND-R	UTD413G-TND-R	TO-252D	G	D	S	Tape Reel

Note: Pin Assignment: G: Gate D: Drain S: Source

<p>UTD413G-AA3-R</p> <p>(1) Packing Type (2) Package Type (3) Green Package</p>	<p>(1) R: Tape Reel (2) AA3: SOT-223, TN3: TO-252, TND: TO-252D (3) G: Halogen Free and Lead Free, L: Lead Free</p>
---	---

#### MARKING

SOT-223	TO-252 / TO-252D
<p>UTD413G □□□ → Data Code</p> <p>1</p>	<p>UTC UTD413 □□□□□□ → Lot Code □□□□□□ → Data Code</p> <p>1</p> <p>L: Lead Free G: Halogen Free</p>

■ ABSOLUTE MAXIMUM RATINGS ( $T_A=25^{\circ}\text{C}$ , unless otherwise specified)

PARAMETER	SYMBOL	RATINGS	UNIT
Drain-Source Voltage	$V_{DSS}$	-40	V
Gate-Source Voltage	$V_{GSS}$	$\pm 20$	V
Continuous Drain Current	$I_D$	-12	A
Pulsed Drain Current	$I_{DM}$	-30	A
Avalanche Current	$I_{AR}$	-12	A
Repetitive avalanche energy $L=0.1\text{mH}$	$E_{AR}$	30	mJ
Power Dissipation	SOT-223	0.78	W
	TO-252/TO-252D	2.5	W
Junction Temperature	$T_J$	+175	$^{\circ}\text{C}$
Storage Temperature	$T_{STG}$	-55 ~ +175	$^{\circ}\text{C}$

Notes: 1. Absolute maximum ratings are those values beyond which the device could be permanently damaged. Absolute maximum ratings are stress ratings only and functional device operation is not implied.

2. Pulse width limited by  $T_{J(MAX)}$

■ THERMAL DATA

PARAMETER	SYMBOL	RATINGS	UNIT
Junction to Ambient	SOT-223	160	$^{\circ}\text{C/W}$
	TO-252/TO-252D	50	$^{\circ}\text{C/W}$
Junction to Case	SOT-223	12	$^{\circ}\text{C/W}$
	TO-252/TO-252D	3	$^{\circ}\text{C/W}$

Note: When surface mounted to an FR4 board using minimum recommended pad size. (Cu. Area 0.412 sq in), Steady State.

■ ELECTRICAL CHARACTERISTICS ( $T_J=25^{\circ}\text{C}$ , unless otherwise specified)

PARAMETER	SYMBOL	TEST CONDITIONS	MIN	TYP	MAX	UNIT
<b>OFF CHARACTERISTICS</b>						
Drain-Source Breakdown Voltage	$BV_{DSS}$	$V_{GS}=0\text{V}, I_D=-10\text{mA}$	-40			V
Drain-Source Leakage Current	$I_{DSS}$	$V_{DS}=-32\text{V}, V_{GS}=0\text{V}$			-1	$\mu\text{A}$
Gate-Source Leakage Current	$I_{GSS}$	$V_{DS}=0\text{V}, V_{GS}=\pm 20\text{V}$			$\pm 100$	nA
<b>ON CHARACTERISTICS</b>						
Gate Threshold Voltage	$V_{GS(TH)}$	$V_{DS}=V_{GS}, I_D=-250\mu\text{A}$	-1	-1.9	-3	V
On State Drain Current	$I_{D(ON)}$	$V_{DS}=-5\text{V}, V_{GS}=-10\text{V}$	-30			A
Static Drain-Source On-Resistance	$R_{DS(ON)}$	$V_{GS}=-10\text{V}, I_D=-12\text{A}$		36	45	m $\Omega$
		$V_{GS}=-4.5\text{V}, I_D=-8\text{A}$		51	69	
<b>DYNAMIC PARAMETERS</b>						
Input Capacitance	$C_{ISS}$	$V_{DS}=-20\text{V}, V_{GS}=0\text{V}, f=1\text{MHz}$		657		pF
Output Capacitance	$C_{OSS}$			143		pF
Reverse Transfer Capacitance	$C_{RSS}$			63		pF
<b>SWITCHING PARAMETERS</b>						
Total Gate Charge	10V	$Q_G$	$V_{DS}=-20\text{V}, V_{GS}=-10\text{V}, I_D=-12\text{A}$	14.1		nC
	4.5V			7		
Gate Source Charge	$Q_{GS}$			2.2		nC
Gate Drain Charge	$Q_{GD}$			4.1		nC
Turn-ON Delay Time	$t_{D(ON)}$			8		ns
Turn-ON Rise Time	$t_R$	$V_{GS}=-10\text{V}, V_{DS}=-20\text{V}, R_L=1.7\Omega, R_G=3\Omega$		12.2		ns
Turn-OFF Delay Time	$t_{D(OFF)}$			24		ns
Turn-OFF Fall-Time	$t_F$			12.5		ns
<b>SOURCE- DRAIN DIODE RATINGS AND CHARACTERISTICS</b>						
Diode Forward Voltage	$V_{SD}$	$I_S=12\text{A}, V_{GS}=0\text{V}$		-0.75	-1.2	V
Maximum Body-Diode Continuous Current	$I_S$				-12	A
Body Diode Reverse Recovery Time	$t_{RR}$	$I_F=-12\text{A}, dI/dt=100\text{A}/\mu\text{s}$		23.2		ns
Body Diode Reverse Recovery Charge	$Q_{RR}$	$I_F=-12\text{A}, dI/dt=100\text{A}/\mu\text{s}$		18.2		nC

## TYPICAL CHARACTERISTICS

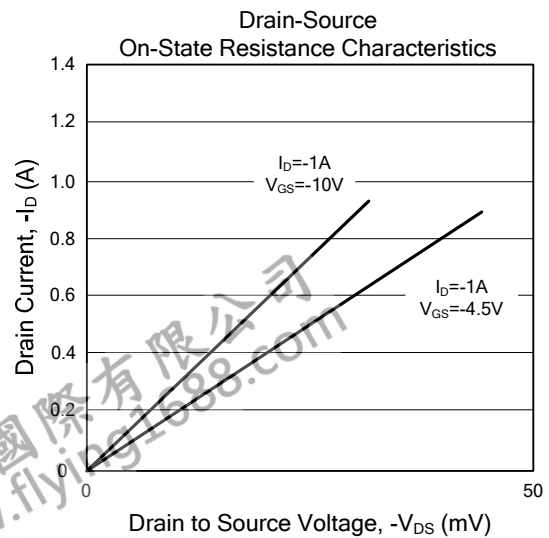
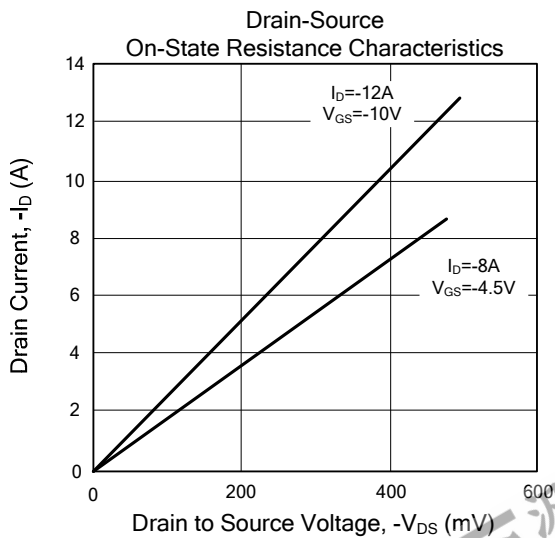
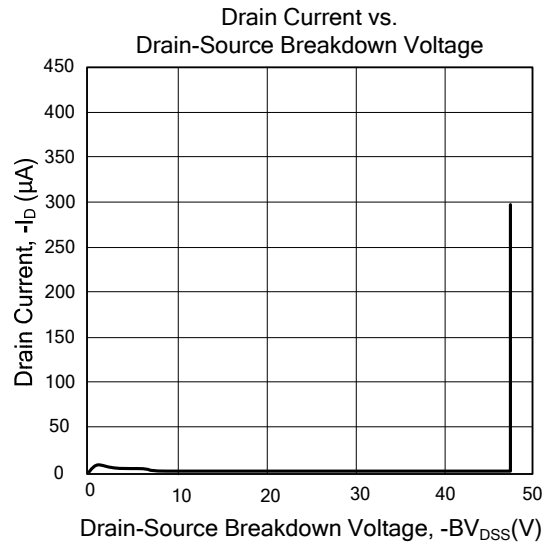
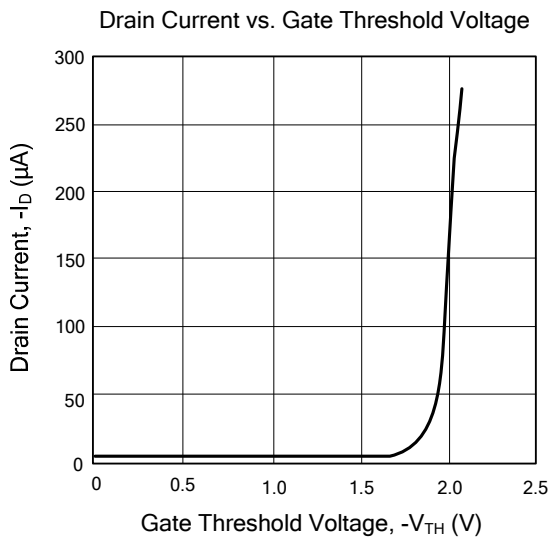
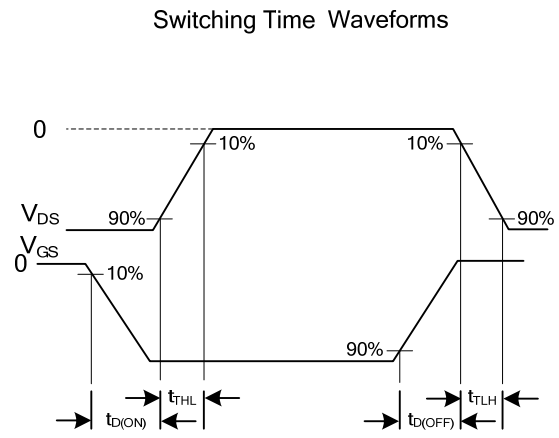
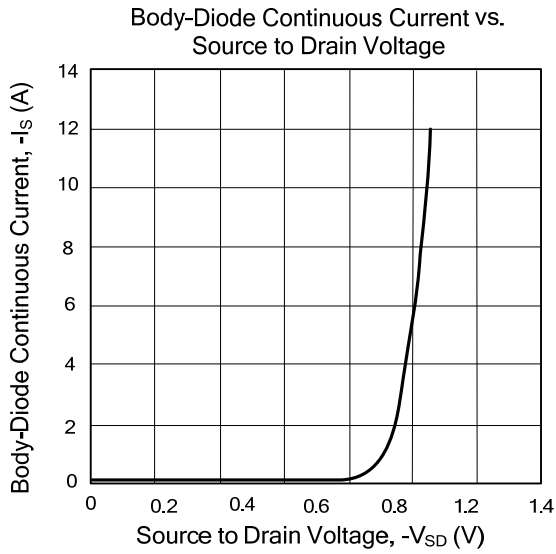

UTC assumes no responsibility for equipment failures that result from using products at values that exceed, even momentarily, rated values (such as maximum ratings, operating condition ranges, or other parameters) listed in products specifications of any and all UTC products described or contained herein. UTC products are not designed for use in life support appliances, devices or systems where malfunction of these products can be reasonably expected to result in personal injury. Reproduction in whole or in part is prohibited without the prior written consent of the copyright owner. The information presented in this document does not form part of any quotation or contract, is believed to be accurate and reliable and may be changed without notice.